

ThinkPad E14 Gen 5 and ThinkPad E16 Gen 1 User Guide

Lenovo
ThinkPad



Lenovo

Read this first

Before using this documentation and the product it supports, ensure that you read and understand the following:

- *Safety and Warranty Guide*
- *Setup Guide*
- [Generic Safety and Compliance Notices](#)

Third Edition (July 2024)

© Copyright Lenovo 2024.

LIMITED AND RESTRICTED RIGHTS NOTICE: If data or software is delivered pursuant to a General Services Administration "GSA" contract, use, reproduction, or disclosure is subject to restrictions set forth in Contract No. GS-35F-05925.

Contents

Discover your Lenovo notebook.iii

Chapter 1. Meet your computer. 1

Front view	1
Side view	5
Features and specifications	8
USB specifications.	8

Chapter 2. Get started with your computer. 11

Access networks	11
Connect to Wi-Fi networks.	11
Connect to the wired Ethernet	11
Turn on Airplane mode	12
Interact with your computer	12
Use the keyboard shortcuts	12
Use the TrackPoint pointing device	14
Use the trackpad	15
Use the touch screen (for selected models)	16
Connect to an external display	18

Chapter 3. Explore your computer 21

Lenovo apps	21
Lenovo Vantage	21
AI Meeting Manager (for selected models).	21
Lenovo Smart Appearance (for selected models)	22
Lenovo Smart Meeting	24
Intelligent cooling	25
Manage power	26
Check the battery status	27
Charge the computer	27
Change the power settings	28
Transfer data	28
Set up a Bluetooth connection	28
Accessories	29
Purchase accessories	29

Chapter 4. Secure your computer and information 31

Lock the computer	31
Log in with your fingerprint (for selected models)	31
Log in with your face ID (for selected models)	32
Protect data against power loss (for selected models)	32
UEFI BIOS passwords	32
Password types	32

Set, change, and remove a password	33
FIDO (Fast Identity Online) authentication	34

Chapter 5. Configure advanced settings. 37

UEFI BIOS	37
Enter the UEFI BIOS menu.	37
Navigate in the UEFI BIOS interface	37
Set the system date and time.	37
Change the startup sequence	37
View UEFI BIOS Event logs	37
Customize BIOS Defaults (for Intel models only)	38
Reset system to factory defaults	39
Update UEFI BIOS	39
Cloud bare metal recovery (for selected models)	40
Install a Windows operating system and drivers	40
Install device drivers	41

Chapter 6. CRU replacement 43

CRU list	43
Disable Fast Startup and the built-in battery.	43
Replace a CRU	44
Base cover assembly	44
Memory module (for selected models)	45
M.2 solid-state drive	47
Speaker assembly (for ThinkPad E16 Gen 1 Only)	49

Chapter 7. Help and support 51

Frequently asked questions	51
Error messages	53
Beep errors	54
Self-help resources	55
Windows label	56
Call Lenovo	56
Before you contact Lenovo	56
Lenovo Customer Support Center	57
Purchase additional services.	58

Appendix A. Compliance information. 59

Appendix B. Notices and trademarks. 61

Discover your Lenovo notebook

Thank you for choosing a Lenovo® notebook! We are dedicated to delivering the best solution to you.

Before starting your tour, please read the following information:









- Illustrations in this documentation might look different from your product.
- Depending on the model, some optional accessories, features, software programs, and user interface instructions might not be applicable to your computer.
- Documentation content is subject to change without notice. To get the latest documentation, go to <https://pcsupport.lenovo.com>.

Chapter 1. Meet your computer

Front view

ThinkPad E14 Gen 5











Item	Description	Item	Description
	Infrared camera / Camera		Webcam privacy shutter
	Microphone		Touch screen
	Power button / power button with fingerprint reader		TrackPoint® pointing stick
	Trackpad		TrackPoint buttons

* for selected models

ThinkPad E16 Gen 1



Item	Description	Item	Description
	Infrared camera / Camera		Webcam privacy shutter
	Microphone		Touch screen
	Power button / power button with fingerprint reader		TrackPoint pointing stick
	Trackpad		TrackPoint buttons

* for selected models



Webcam privacy shutter

Slide the webcam privacy shutter to cover or uncover the camera lens. It is designed to protect your privacy.







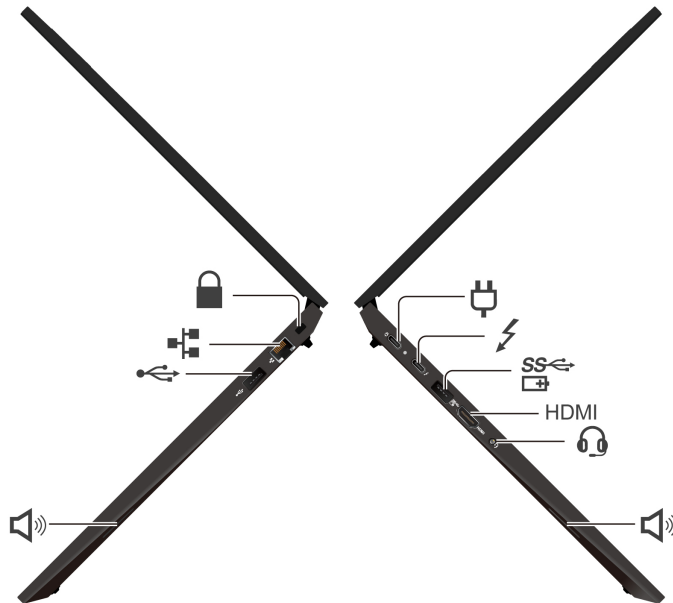

Related topics

- “Use the TrackPoint pointing device” on page 14
- “Use the trackpad” on page 15
- “Use the touch screen (for selected models)” on page 16
- “Log in with your fingerprint (for selected models)” on page 31
- “Log in with your face ID (for selected models)” on page 32

Side view

Intel models







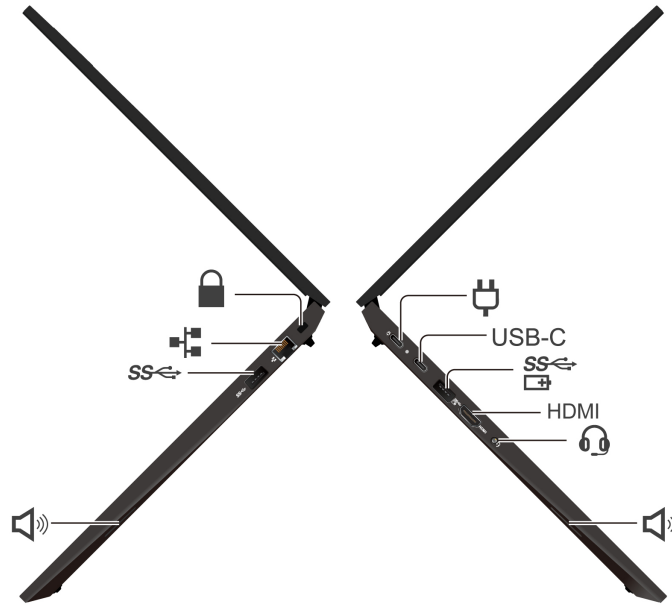

Item	Description	Item	Description
	USB-C® power connector		USB-C (Thunderbolt™ 4) connector
	Always On USB-A 3.2 Gen 1 connector		HDMI™ connector
	Audio connector		Speaker
	Security-lock slot		Ethernet connector
	USB-A 2.0 connector		

*for selected models

AMD models



Item	Description	Item	Description
	USB-C power connector	USB-C	USB-C (3.2 Gen 2) connector
	Always On USB-A 3.2 Gen 1 connector	HDMI	HDMI connector
	Audio connector		Speaker
	Security-lock slot		Ethernet connector
	USB-A 3.2 Gen 1 connector		

*for selected models

Statement on USB transfer rate

Depending on many factors such as the processing capability of the host and peripheral devices, file attributes, and other factors related to system configuration and operating environments, the actual transfer rate using the various USB connectors on this device will vary and will be slower than the data rate listed below for each corresponding device.

USB device	Data rate (Gbit/s)
3.2 Gen 1	5
3.2 Gen 2	10
3.2 Gen 2 × 2	20
4 Gen 2 × 2	20
4 Gen 3 × 2	40

USB device	Data rate (Gbit/s)
Thunderbolt 3	40
Thunderbolt 4	40

Related topics

- “USB specifications” on page 8
- “Charge the computer” on page 27
- “Lock the computer” on page 31

Features and specifications

Specification	Description
Memory	Double Data Rate 4 (DDR4) Small Outline Dual Inline Memory Module (SODIMM), up to 32 GB <ul style="list-style-type: none">• Intel models: DDR4, soldered on board, up to 16 GB• AMD models: DDR4, soldered on board, up to 8 GB
Storage device	Intel models: Two slots, 2242 M.2 solid-state drive, up to 1 TB for each, up to 2 TB in total AMD models: Two slots, one for 2242 M.2 solid-state drive, up to 512 GB; one for 2280 M.2 solid-state drive, up to 1 TB
Audio	<ul style="list-style-type: none">• Dolby Atmos®• Dolby Voice®
Display	<ul style="list-style-type: none">• Color display with In-Plane Switching (IPS) technology• Display ratio: 16:10• Display resolution: 1920 x 1200 pixels, 2240 x 1400 pixels, or 2560 x 1600 pixels• Multi-touch technology*
Security features	<ul style="list-style-type: none">• Face authentication*• Fingerprint reader* (integrated in power button)• Lenovo Smart Appearance Presence Detection*• Lenovo Smart Appearance Privacy Protection*• Trusted Platform Module (TPM)*
Wireless features	<ul style="list-style-type: none">• Bluetooth• Wireless LAN

* for selected models

USB specifications

Note: Depending on the model, some USB connectors might not be available on your computer.

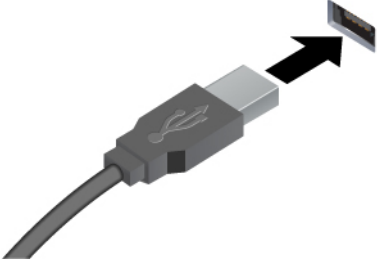
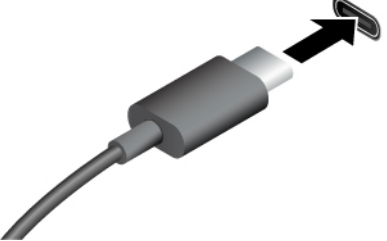
Connector name	Description
 <ul style="list-style-type: none"><li data-bbox="196 562 456 590">• USB-A 2.0 connector<li data-bbox="196 600 526 627">• USB-A 3.2 Gen 1 connector<li data-bbox="196 638 526 665">• USB-A 3.2 Gen 2 connector	<p data-bbox="711 422 1409 478">Connect USB-compatible devices, such as a USB keyboard, USB mouse, USB storage device, or USB printer.</p> <ul style="list-style-type: none"><li data-bbox="711 810 1409 867">• Charge USB-C compatible devices with the output voltage and current of 5 V and 3 A.<li data-bbox="711 877 1409 989">• Connect to an external display:<ul style="list-style-type: none"><li data-bbox="740 919 1273 947">– USB-C to VGA: up to 1920 x 1080 pixels, 60 Hz<li data-bbox="740 957 1256 984">– USB-C to DP: up to 5120 x 2880 pixels, 60 Hz<li data-bbox="711 999 1409 1083">• Connect to USB-C accessories to help expand your computer functionality. To purchase USB-C accessories, go to <a data-bbox="740 1031 1377 1083" href="https://www.lenovo.com/accessories">https://www.lenovo.com/accessories.
 <ul style="list-style-type: none"><li data-bbox="196 1003 542 1031">• USB-C (3.2 Gen 1) connector<li data-bbox="196 1041 542 1068">• USB-C (3.2 Gen 2) connector<li data-bbox="196 1079 586 1106">• USB-C (Thunderbolt 3) connector<li data-bbox="196 1117 586 1144">• USB-C (Thunderbolt 4) connector<li data-bbox="196 1155 509 1182">• USB-C (USB 4) connector	

Chapter 2. Get started with your computer

Access networks

This section helps you connect to a wireless or wired network.

Connect to Wi-Fi networks

Click the network icon in the Windows® notification area, and then select a network for connection. Provide required information, if needed.

- For models with Windows 10:

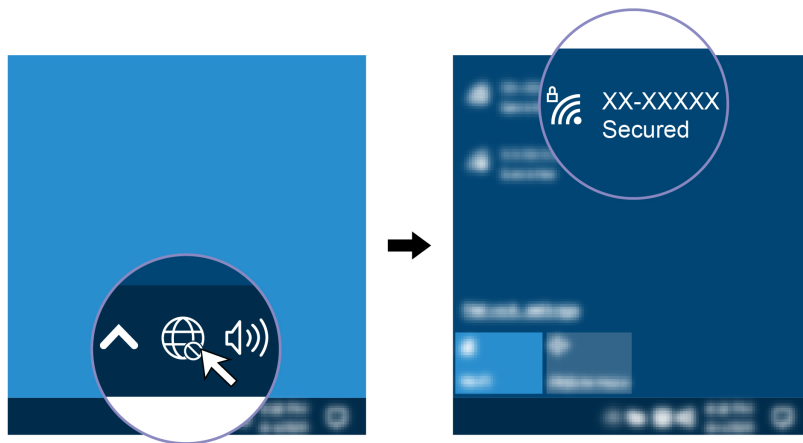

- For models with Windows 11:

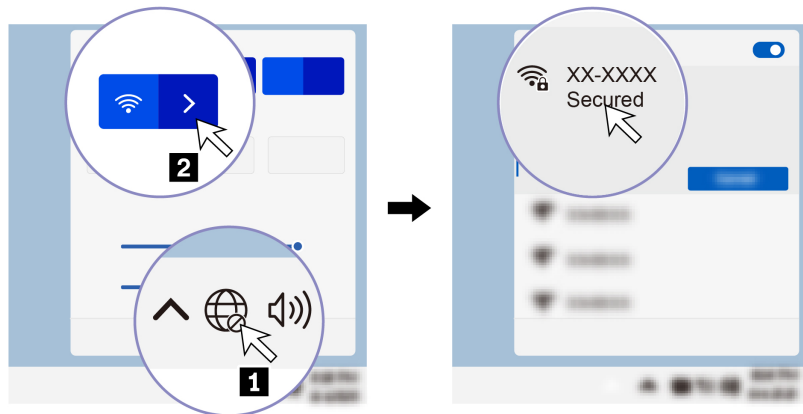

Connect to the wired Ethernet

Connect your computer to a local network through the Ethernet connector on your computer with an Ethernet cable.

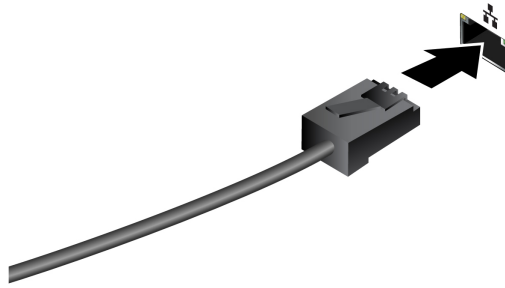

Turn on Airplane mode

When Airplane mode is enabled, all wireless features are disabled.

1. Type Airplane mode in the Windows search box and then press Enter.
2. Turn on Airplane mode.

Interact with your computer











Your computer provides you various ways to navigate the screen.

















Use the keyboard shortcuts

The special keys on the keyboard help you work more effectively.



<https://support.lenovo.com/us/en/videos/vid500145>

Key / Key combination	Function
 + 	Invoke the special function printed as an icon on each key or standard function of F1–F12 function keys. FnLock indicator on: standard function FnLock indicator off: special function
	Enable / disable speakers
	Decrease volume
	Increase volume
	Enable / disable microphones
	Darken display
	Brighten display
	Manage external displays
	Enable / disable Airplane mode

Key / Key combination	Function
	Open the notification center
	Answer incoming calls on Microsoft Teams®
	Decline incoming calls on Microsoft Teams
	Customize the function of this key on the Vantage app
	Open Magnifier
	Open calculator (for ThinkPad E16 Gen 1 only)
	Enter sleep mode (for ThinkPad E16 Gen 1 only)
	Open Snipping Tool
	Toggle keyboard backlight (for selected models)
	Break operation
	Pause operation
	Scroll contents
	Send system request
	Open system information Window
	Enter sleep mode To wake up the computer, press any key
	Go to beginning
	Go to end

Use the TrackPoint pointing device

The TrackPoint pointing device enables you to perform all the functions of a traditional mouse, such as pointing, clicking, and scrolling.

Use the TrackPoint pointing device

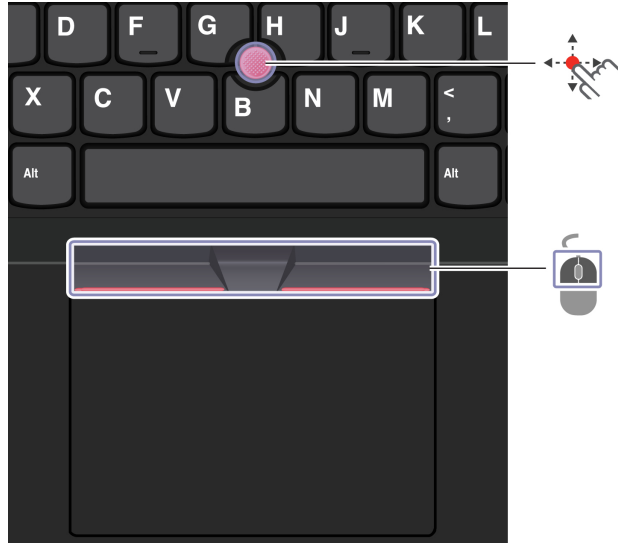

TrackPoint pointing stick

Use your finger to apply pressure to the pointing-stick nonslip cap (hereafter referred to as the red cap) in any direction parallel to the keyboard. The pointer on the screen moves accordingly. The higher the pressure applied, the faster the pointer moves.



TrackPoint Three Buttons

The TrackPoint left button and TrackPoint right button correspond to the left and right buttons on a traditional mouse. Press and hold the TrackPoint center button while using your finger to applying pressure to the pointing stick in the vertical or horizontal direction. Then, you can scroll through the document, Web site, or apps.

Press **Ctrl+TrackPoint center button+TrackPoint pointing stick** at the same time to zoom in or zoom out.

Disable the TrackPoint pointing device

The TrackPoint pointing device is enabled by default. To disable the device:

1. Type **Mouse settings** in the Windows search box and then press Enter.
2. Click **TrackPoint settings** and then follow the on-screen instructions to change the settings.

Replace the pointing-stick nonslip cap

Note: Ensure that the new cap has grooves **a**.

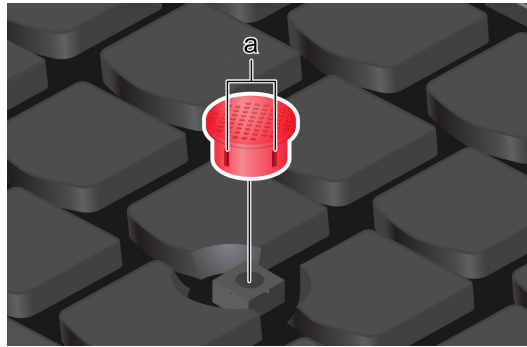



Use the trackpad

You can use the trackpad to perform all the pointing, clicking, and scrolling functions of a traditional mouse.

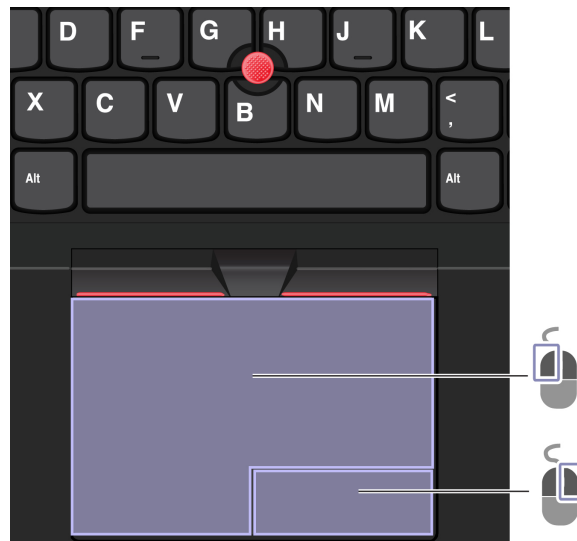
Use the trackpad



Item	Description	Item	Description
	Left-click zone		Right-click zone

Use the touch gestures

Illustration and description

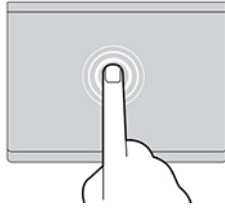

Tap once to select or open an item.

Illustration and description

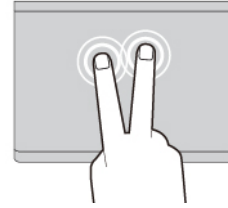

Tap twice quickly to display a shortcut menu.

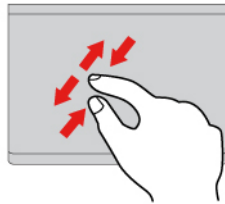

Two-finger zoom in or zoom out.

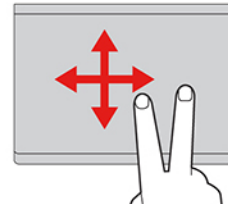

Scroll through items.

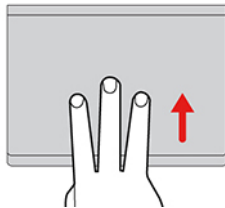

Open the task view to see all open windows.

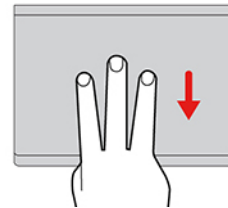

Show the desktop.

Notes:

- When using two or more fingers, ensure that you position your fingers slightly apart.
- Some gestures are not available if the last action was done from the TrackPoint pointing device.
- Some gestures are only available when you are using certain apps.
- If the trackpad surface is stained with oil, turn off the computer first. Then, gently wipe the trackpad surface with a soft and lint-free cloth moistened with lukewarm water or computer cleaner.

For more gestures, see the help information of the pointing device.

Disable the trackpad

The trackpad is enabled by default. To disable the device:

1. Open the **Start** menu, and then click **Settings** → **Bluetooth & devices** → **Touchpad**.
2. In the **Touchpad** section, turn off the **Touchpad** control.

Use the touch screen (for selected models)

If your computer display supports the multi-touch function, you can navigate the screen with simple touch gestures. For more touch gestures, refer to <https://support.microsoft.com/windows>.

Note: Some gestures might not be available when you are using certain apps.

Illustration and description



Tap once to single click



Tap and hold to right-click

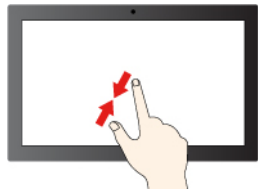

Zoom out

Illustration and description



Tap twice quickly to double-click

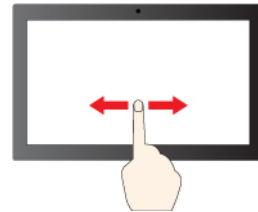

Slide to scroll through items

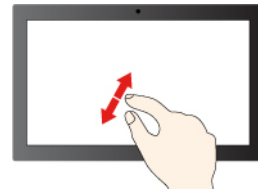

Zoom in

Illustration and description

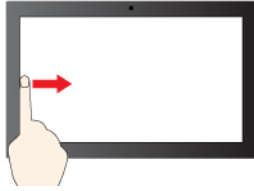

Swipe from the left: view all open windows (Windows 10)

Swipe from the left: open widget panel (Windows 11)

Illustration and description

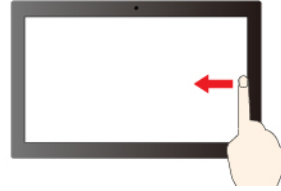

Swipe from the right: open action center (Windows 10)

Swipe from the right: open notification center (Windows 11)

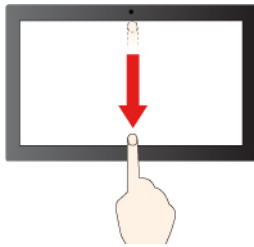

Swipe downwards shortly: show title bar

Swipe downwards: close the current app

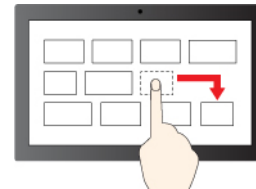

Drag

Maintenance tips:

- Turn off the computer before cleaning the touch screen.
- Use a dry, soft, and lint-free cloth or a piece of absorbent cotton to remove fingerprints or dust from the touch screen. Do not apply solvents to the cloth.
- The touch screen is a glass panel covered with a plastic film. Do not apply pressure or place any metallic object on the screen, which might damage the touch panel or cause it to malfunction.
- Do not use fingernails, gloved fingers, or inanimate objects for input on the screen.
- Regularly calibrate the accuracy of the finger input to avoid a discrepancy.

Connect to an external display

Connect your computer to a projector or a monitor to give presentations or expand your workspace.

Connect to a wired display

If your computer cannot detect the external display, right-click a blank area on the desktop and select **Display settings**. Then follow the on-screen instructions to detect the external display.

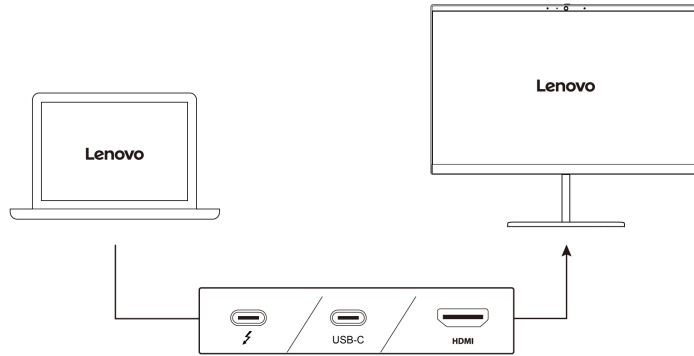

Supported resolution

The following table lists the supported maximum resolution of the external display.

Table 1. Intel models

Connect the external display to	Supported resolution
USB-C connector	Up to 4K / 60 Hz
Thunderbolt 4 connector	Up to 5K/ 60 Hz
HDMI connector	Up to 4K / 60 Hz

Table 2. AMD models

Connect the external display to	Supported resolution
USB-C connector	Up to 5K / 60 Hz
HDMI connector	Up to 4K/ 30 Hz

Notes: The refresh rate higher than 60 Hz can also be supported. If you set the refresh rate higher than 60 Hz, the maximum resolution might be limited.



- For Intel models, the HDMI connector supports the HDMI 2.0 standard. Connect to a compatible digital audio device or video monitor, such as an HDTV.
- For AMD models, the HDMI connector supports the HDMI 1.4 standard by default. Use a qualified HDMI 1.4 cable to connect an external display to your computer.

Connect to a wireless display

To use a wireless display, ensure that both your computer and the external display support the Miracast® feature.

Press Windows logo key+K and then select a wireless display to connect with.

Set the display mode

Press  or  +  and then select a display mode of your preference.

Change display settings

1. Right-click a blank area on the desktop and select **Display settings**.

2. Select the display that you want to configure and change display settings of your preference.

You can change the settings for both the computer display and the external display. For example, you can define which one is the main display and which one is the secondary display. You also can change the resolution and orientation.

Chapter 3. Explore your computer

Lenovo apps

This section provides introduction to Lenovo apps.

Lenovo Vantage

The Lenovo Vantage app (hereafter referred to as Vantage app) is a customized one-stop solution to help you maintain your computer with automated updates and fixes, configure hardware settings, and get personalized support.

To access the Vantage app, type *Lenovo Vantage* in the Windows search box.

Notes:

- The available features vary depending on the computer model.
- The Vantage app makes periodic updates of the features to keep improving your experience with your computer. The description of features might be different from that on your actual user interface. Ensure that you use the latest version of Vantage app, and apply Windows Update to get the latest updates.

The Vantage app enables you to:

- Know the device status easily and customize device settings.
- Download and install UEFI BIOS, firmware, and driver updates to keep your computer up-to-date.
- Monitor your computer health, and secure your computer against outside threats.
- Scan your computer hardware and diagnose hardware problems.
- Look up *warranty status* (online).
- Access *User Guide* and helpful articles.

AI Meeting Manager (for selected models)



AI Meeting Manager helps you to be more productive and efficient in intercultural meetings without language barriers. It converts voice to text, makes real-time translation (from voice to text), records audio speech and translated text to help you take meeting minutes.

Access the app

To access AI Meeting Manager, do one of the following:

- Open the **Start** menu and click **AI Meeting Manager**.
- Type AI Meeting Manager in the search box.

Translator/Subtitles

This function translates voice or audio into on-screen text in real time during meetings.

The subtitle function allows you to watch foreign videos with translated subtitle.

Voice-to-text

This function converts voice to text. Select any typable field (such as document editing area, web site browser input field, and windows input bar) to input text using voice instead of typing.

Editor

After a meeting, all audio and translated text are saved in your computer. Open Editor and you can view the record. This function makes it easier to edit meeting minutes. You can copy, search, proofread, export, or delete text, and you also can delete or play audio back.

Notes:

- To download the latest version of AI Meeting Manager, go to Microsoft Store and search for the app name.
- The supported features and languages vary depending on the computer model and delivery of countries and regions.
- AI Meeting Manager makes periodic updates of the features to keep improving your experience. The description of features might be different from that on your actual user interface.

Lenovo Smart Appearance (for selected models)



Lenovo Smart Appearance is an intelligent camera enhancement and privacy protection app. It enhances your looks in video calls and captures your head movement to make your computer smarter.

It works with some mainstream video call apps, such as Microsoft Teams. The settings that you made on this app also take effect on supported video call apps.

Access the app

To access Lenovo Smart Appearance, type `Lenovo Smart Appearance` in the Windows search box.

Explore key features

- **Smart Appearance**
 - **Background:** Blur or customize your background in the video call to protect your privacy.

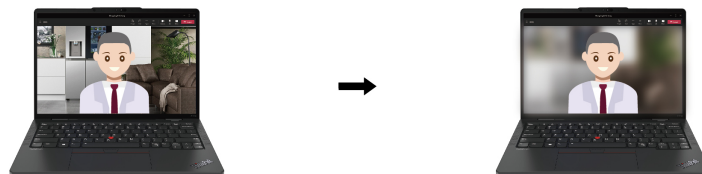

- **Face Framing:** Automatically keep your face centered in the video call when you move around.

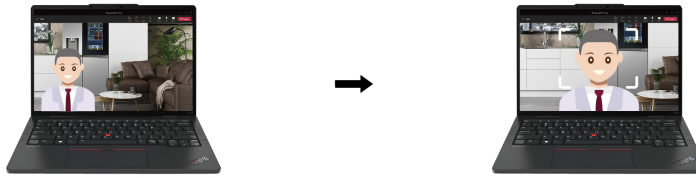

- **Video Enhancer:** Automatically adjust the light effect to show your face and surroundings more clearly in the video call.

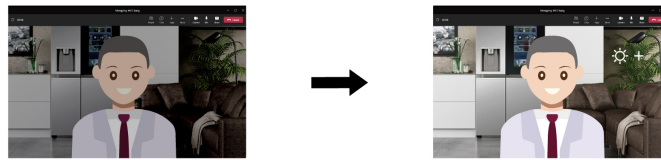

- **Intelligent Sensing**

- **Presence Detection:** Keep your computer awake when in use and automatically lock the computer screen after your head moves out of the camera range.

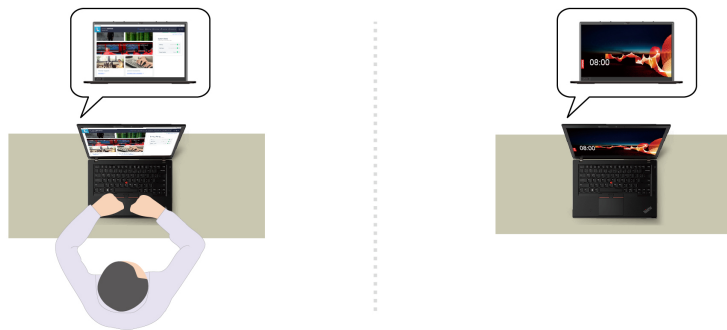

- **Privacy Protection:** When a shoulder surfer is detected, your screen becomes blurred followed by a warning message.

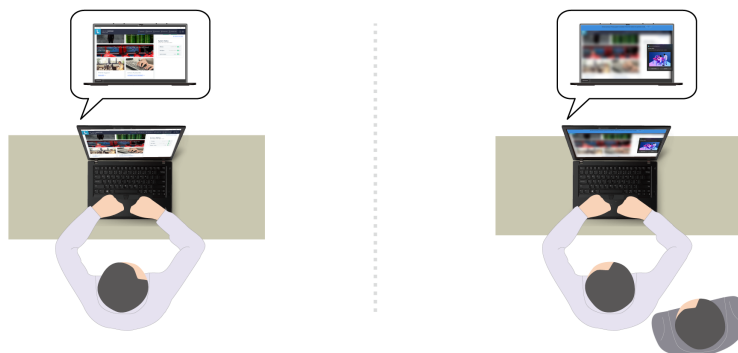

- **Adaptive Dimming:** Track your face movement to recognize your attention focus. When you are facing away, the display dims to save battery power.

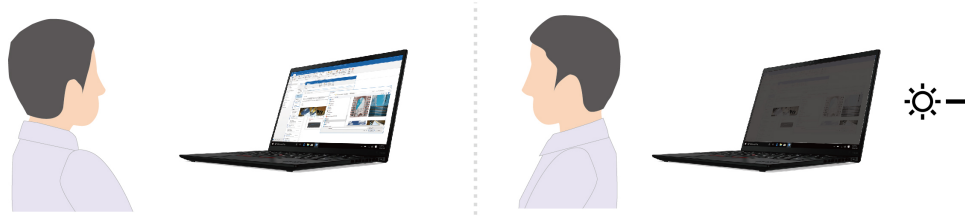

Notes:

- The available features vary depending on the computer model.
- Lenovo Smart Appearance makes periodic updates of the features to keep improving your experience with your computer. The description of features might be different from that on your actual user interface.

Lenovo Smart Meeting

Lenovo Smart Meeting is a video conferencing app for working scenarios. It integrates multiple features to help enhance your professional image, protect your privacy, and reduce power consumption.

If you want your configurations of the app also take effect on other mainstream video call apps, such as Microsoft Teams and Zoom, ensure that you select Lenovo Virtual Camera in the app.

Access the app

Type **Lenovo Smart Meeting** in the Windows search box and then press Enter.

Explore key features

- **Smart appearance**
 - **Video enhancer:** Adjust the brightness automatically for better image quality in the video call.

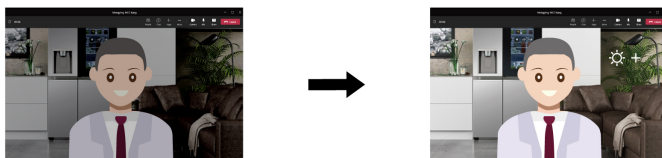

- **Face framing:** Keep your face centered in the video call automatically when you move around.

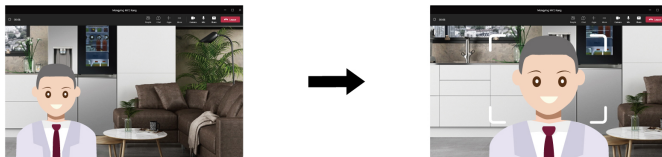

- **Customized background:** Blur or customize your background in the video call to protect your privacy.

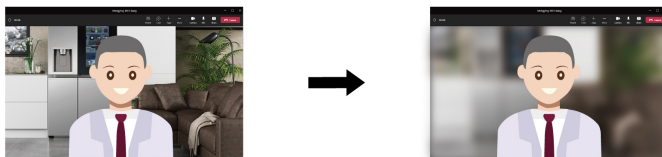

Notes:

- Lenovo does not collect any personal data from this app.
- The available features vary depending on the computer model.
- Lenovo Smart Meeting makes periodic feature updates to keep improving your experience with your computer. The description described here might be different from that on your actual user interface.

Intelligent cooling



The Intelligent Cooling feature helps you adjust power consumption, fan speed, computer temperature, and performance.

Note: For models with discrete GPU, the appropriate GPU will be used based on the Intelligent Cooling mode. If the mode is switched while an app is running, the app might restart to ensure that the appropriate GPU is used. If you have specified the exact GPU to run for each app in the Windows Settings, it will take precedence.

For models with Windows 10

The intelligent Cooling feature is adjusted through Windows Power Slider. This feature works in auto mode by default. Press Fn+T to enable or disable the auto mode.

Note: Auto mode is for Intel models with discrete GPU only.

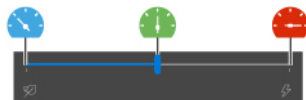

- **When the auto mode is disabled**, do the following to select a preferred mode:
 1. Click the battery status icon in the Windows notification area.
 2. Move the slider to the left or right to select a preferred mode.
- **For models with discrete GPU**
 -  Eco mode: power consumption, fan speed, and performance are lowered to get your computer quieter and more eco-friendly, and to get the best battery life.
 -  Balanced mode: power consumption, fan speed, and performance are balanced.
 -  Ultra-performance mode: the ultra performance is prioritized, allowing maximum temperature and higher fan speed.

on ac power



on battery power



- **For models without discrete GPU**
 -  Eco mode: power consumption, fan speed, and performance are lowered to get your computer quieter and more eco-friendly, and to get the best battery life.
 -  Balanced mode: power consumption, fan speed, and performance are balanced.
 -  Performance mode: The performance is prioritized, allowing higher temperature and fan speed.



- **When the auto mode is enabled**

- **A** Auto mode: your computer is adjusted automatically to achieve the best mix of power consumption, battery life, computer performance, and fan speed based on the amount of system activity.

For models with Windows 11

The intelligent Cooling feature is adjusted through Windows Settings. This feature works in auto mode by default. Press Fn+T to enable or disable the auto mode.

Note: Auto mode is for Intel models with discrete GPU only.

1. Right-click the battery icon in the task bar to access power and sleep settings.
2. Locate the Power section and choose one of the following power modes.

- **When the auto mode is disabled:**

- **Best Power efficiency:** power consumption, fan speed, and performance are lowered to get your computer quieter and more eco-friendly, and to get the best battery life.
- **Balanced:** power consumption, fan speed, and performance are balanced.
- **Best Performance:**
 - **For models with discrete GPU:** the ultra performance is prioritized, allowing maximum temperature and higher fan speed.
 - **For models without discrete GPU:** the performance is prioritized, allowing higher temperature and fan speed.

- **When the auto mode is enabled**, it is recommended to set the power mode to **Balanced**. Then your computer will be adjusted automatically to achieve the best mix of power consumption, battery life, computer performance, and fan speed based on the amount of system activity.

Intelligent Cooling Boost (for AMD models only)

The Intelligent Cooling Boost feature dynamically adjusts system performance based on the apps you are running. It is recommended that you enable this function especially when using unified communication apps (such as Microsoft Teams).

Note: Ensure that you use this feature in balanced mode to have the best user experience.

To enable or disable the intelligent Cooling Boost feature, do the following:

1. Enter the UEFI BIOS menu. See “Enter the UEFI BIOS menu” on page 37
2. Select **Config → Power**.
3. In the **Intelligent Cooling Boost** section, turn on/off the Intelligent Cooling Boost switch.
4. Press F10 to save changes and exit the UEFI BIOS menu.

Manage power

Use the information in this section to achieve the best balance between performance and power efficiency.

Check the battery status

Go to **Settings** → **System** to check the battery status. For more details about your battery, refer to the Vantage app.

Charge the computer

Use ac power

Power source of the ac power adapter:

- Power: 65 W
- Sine-wave input at 50 Hz to 60 Hz
- Input rating of the ac power adapter: 100 V to 240 V ac, 50 Hz to 60 Hz
- Output rating of the ac power adapter: 20 V dc, 3.25 A

When the battery power is low, charge your battery by connecting your computer to ac power with the supplied power adapter. The 65 W ac power adapter supports the rapid charge function, the battery is 80% charged in about one hour when the computer is turned off. The actual charging time depends on the battery size, the physical environment, and whether you are using the computer.

Battery charging is also affected by its temperature. The recommended temperature range for charging the battery is between 10°C (50°F) and 35°C (95°F).

Note: Some models might not ship with ac adapters or power cords. Use only the certified adapters and power cords provided by Lenovo that comply with the requirements of relevant national standards to charge the product. It is recommended to use the Lenovo qualified adapters. You can refer to <https://www.lenovo.com/us/en/compliance/eu-doc>.

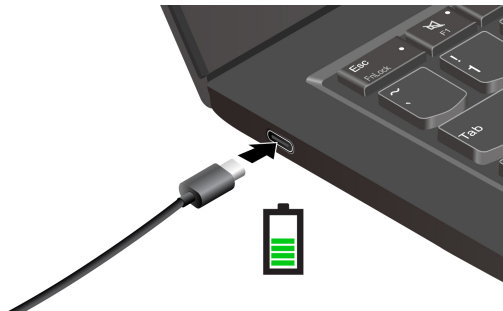

Notes: To maximize the life of the battery:

- Use the battery until the charge is depleted and recharge the battery completely before using it. Once the battery is fully charged, it must discharge to 94% or lower before it will be allowed to recharge again.
- The battery might optimize its full charge capacity based on your usage. After prolonged periods of limited use, full battery capacity might not be available until you discharge to as low as 20% and recharge completely. For more information, refer to the power section of the Vantage app.

Use P-to-P 2.0 (Peer to Peer 2.0) charging function

Both USB-C (Thunderbolt 4) connectors on the computer feature the Lenovo-unique P-to-P 2.0 charging function. To use the function, ensure that **Always On USB** and **Charge in Battery Mode** are enabled in UEFI BIOS of your computers, so that the function works even when the computers are off or in hibernation mode.

To enable **Always On USB** and **Charge in Battery Mode**:

1. Press F1 to enter the UEFI BIOS menu.

2. Click **Config** → **USB**, and then to enable **Always On USB** and **Charge in Battery Mode**.

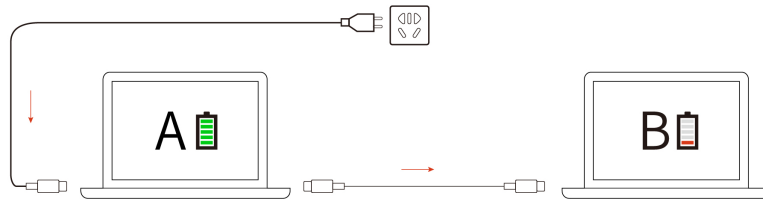

Note: The actual charging speed of your computer depends on many factors, such as the remaining battery power of the computers, the wattage of the ac power adapter, and whether you are using the computers.

Change the power settings

For ENERGY STAR® compliant computers, the following power plan takes effect by default when your computer is on ac power and has been idle for a specified duration:

- For models with Windows 10
 - Turn off the display: After 10 minutes
 - Put the computer to sleep: After 10 minutes
- For models with Windows 11
 - Turn off the display: After 5 minutes
 - Put the computer to sleep: After 5 minutes

To reset the power plan:

1. Go to **Control Panel** and view by Large icons or Small icons.
2. Click **Power Options**.
3. Choose or customize a power plan of your preference.

To reset the power button function:

1. Go to **Control Panel** and view by Large icons or Small icons.
2. Click **Power Options**, and then click **Choose what the power buttons do** on the left pane.
3. Change the settings as you prefer.

Transfer data

Quickly share your files using the built-in Bluetooth technology among devices with the same features.

Set up a Bluetooth connection

You can connect all types of Bluetooth-enabled devices to your computer, such as a keyboard, a mouse, a smartphone, or speakers. To ensure successful connection, place the devices at most 10 meters (33 feet) from the computer.

1. Type **Bluetooth** in the Windows search box and then press Enter.
2. Turn on Bluetooth, if it is off.
3. Select a Bluetooth device, and then follow the on-screen instructions.

Accessories

This section provides instructions on how to use hardware accessories to expand your computer functionalities.

Purchase accessories

Lenovo has a number of hardware accessories and upgrades to help expand the functionalities of your computer. Options include memory modules, storage devices, network cards, port replicators or docking stations, batteries, power adapters, keyboards, mice, and more.

To shop at Lenovo, go to <https://www.lenovo.com/accessories>.

Chapter 4. Secure your computer and information

Lock the computer

Lock your computer to a desk, table, or other fixtures through a compatible security cable lock.

Note: The slot supports cable locks that conform to the Kensington NanoSaver® lock standards using Cleat™ locking technology. You are responsible for evaluating, selecting, and implementing the locking device and security feature. Lenovo is not responsible for the locking device and security feature. You can purchase the cable locks at <https://smartfind.lenovo.com>.

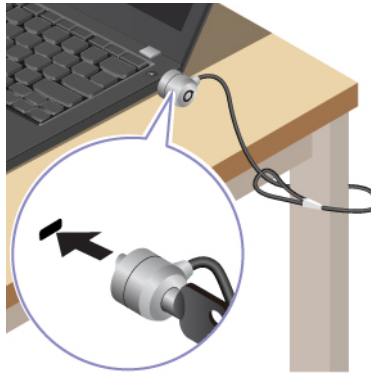

Log in with your fingerprint (for selected models)

The fingerprint reader is integrated with the power button. After enrolling your fingerprint, you can power on and log in to the computer with a simple press on the power button, or unlock the screen with a single touch. It eliminates the need to enter complex passwords, saving your time and boosting your productivity.

1. Type Sign-in options in the Windows search box and then press Enter.
2. Select the fingerprint setting and then follow the on-screen instruction to enroll your fingerprint.

Note: It is recommended that you put your finger at the center of the power button during enrollment and enroll more than one fingerprint in case of any injuries to your fingers. After the enrollment, the fingerprints are associated with the Windows password automatically.

3. Log in with your fingerprint. When the fingerprint reader indicator is solid green, tap your finger on the fingerprint reader for authentication.

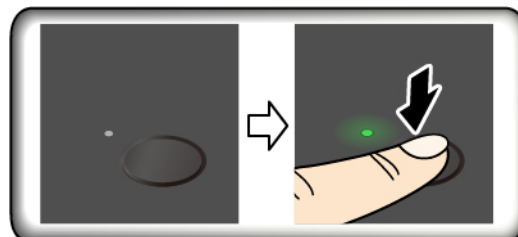

Maintenance tips:

- Do not scratch the surface of the reader with anything hard or sharp.
- Do not use or touch the reader with a wet, dirty, wrinkled, or injured finger.

Log in with your face ID (for selected models)

For models come with a webcam privacy shutter, slide the webcam privacy shutter to uncover the camera lens before using the Windows Hello face recognition.

Create your face ID and unlock your computer by scanning your face:

1. Type Sign-in options in the Windows search box and then press Enter.
2. Select the face ID setting and then follow the on-screen instruction to create your face ID.

Protect data against power loss (for selected models)

NVMe (Non-Volatile Memory express) M.2 solid-state drive features the Lenovo-unique PLP (Power Loss Protection) function to avoid data loss or damage. If your computer is not responding and you might have to shut down your computer by pressing and holding the power button for several seconds. In this case, the PLP function enables your computer data to be saved timely. However, there is no guarantee that all data is saved in any situation. To check the type of your M.2 solid-state drive:

1. Restart the computer. When the logo screen is displayed, press F10 to enter the Lenovo diagnostics window.
2. On the TOOLS tab, select **SYSTEM INFORMATION** → **STORAGE** using the arrow keys.
3. Locate the **Device Type** section to check the information.

UEFI BIOS passwords

You can set passwords in UEFI (Unified Extensible Firmware Interface) BIOS (Basic Input/Output System) to strengthen the security of your computer.

Password types

You can set a power-on password, supervisor password, system management password, or NVMe password in UEFI BIOS to prevent unauthorized access to your computer. However, you are not prompted to enter any UEFI BIOS password when your computer resumes from sleep mode.

Power-on password

If you set a power-on password, a window is displayed on the screen when you turn on the computer. Enter the correct password to use the computer.

Supervisor password

The supervisor password protects the system information stored in UEFI BIOS. When entering the UEFI BIOS menu, enter the correct supervisor password in the window prompted. You also can press Enter to skip the password prompt. However, you cannot change most of the system configuration options in UEFI BIOS.

If you have set both the supervisor password and power-on password, you can use the supervisor password to access your computer when you turn it on. The supervisor password overrides the power-on password.

System management password

The system management password can also protect the system information stored in UEFI BIOS like a supervisor password, but it has lower authority by default. The system management password can be set through the UEFI BIOS menu or through Windows Management Instrumentation (WMI) with the Lenovo client-management interface.

You can enable the system management password to have the same authority as the supervisor password to control security-related features. To customize the authority of the system management password through the UEFI BIOS menu:

1. Restart the computer. When the logo screen is displayed, press F1 to enter the UEFI BIOS menu.
2. Select **Security → Password → System Management Password Access Control**.
3. Follow the on-screen instructions.

If you have set both the supervisor password and the system management password, the supervisor password overrides the system management password. If you have set both the system management password and the power-on password, the system management password overrides the power-on password.

NVMe passwords

The NVMe password prevents unauthorized access to the data on the storage drive. When an NVMe password is set, you are prompted to type a correct password each time you try to access the storage drive.

- **Single Password**

When a Single NVMe password is set, the user must enter the user NVMe password to access files and applications on the storage drive.

- **Dual Password (User + Admin)**

The admin NVMe password is set and used by a system administrator. It enables the administrator to access any storage drive in a system or any computer connected in the same network. The administrator can also assign a user NVMe password for each computer in the network. The user of the computer can change the user NVMe password as desired, but only the administrator can remove the user NVMe password.

When prompted to enter an NVMe password, press F1 to switch between the admin NVMe password and user NVMe password.

Notes: The NVMe password is not available in the following situations:

- A Trusted Computing Group (TCG) Opal-compliant storage drive and a TCG Opal management software program are installed in the computer, and the TCG Opal management software program is activated.
- An eDrive storage drive is installed in the computer preinstalled with the Windows operating system.

Set, change, and remove a password

Before you start, print these instructions.

1. Restart the computer. When the logo screen is displayed, press F1 to enter the UEFI BIOS menu.
2. Select **Security → Password** by using the arrow keys.
3. Select the password type. Then, follow the on-screen instructions to set, change, or remove a password.

You should record all your passwords and store them in a safe place. If you forget any of your passwords, any potential repair actions required are not covered under warranty.

What to do if you forget your power-on password

If you forget your power-on password, do the following to remove the power-on password:

- If you have set a supervisor password and remember it:
 1. Restart the computer. When the logo screen is displayed, immediately press F1.
 2. Type the supervisor password to enter the UEFI BIOS menu.

3. Select **Security → Password → Power-On Password** by using the arrow keys.
 4. Type the current supervisor password in the **Enter Current Password** field. Then, leave the **Enter New Password** field blank, and press Enter twice.
 5. In the Changes have been saved window, press Enter.
 6. Press F10 to save changes and exit the UEFI BIOS menu.
- If you have not set a supervisor password, contact a Lenovo authorized service provider to have the power-on password removed.

What to do if you forget your NVMe password

If you forget your NVMe password (Single password) or both user and admin NVMe passwords (Dual password), Lenovo cannot reset your passwords or recover data from the storage drive. You can contact a Lenovo authorized service provider to have the storage drive replaced. A fee will be charged for parts and service. If the storage drive is a CRU (Customer Replaceable Unit), you can also contact Lenovo to purchase a new storage drive to replace the old one by yourself. To check whether the storage drive is a CRU and the relevant replacement procedure, see Chapter 6 “CRU replacement” on page 43.

What to do if you forget your supervisor password

If you forget your supervisor password, there is no service procedure to remove the password. You have to contact a Lenovo authorized service provider to have the system board replaced. A fee will be charged for parts and service.

What to do if you forget your system management password

If you forget your system management password, do the following to remove the system management password:

- If you have set a supervisor password and remember it:
 1. Restart the computer. When the logo screen is displayed, immediately press F1.
 2. Type the supervisor password to enter the UEFI BIOS menu.
 3. Select **Security → Password → System Management Password** by using the arrow keys.
 4. Type the current supervisor password in the **Enter Current Password** field. Then, leave the **Enter New Password** field blank, and press Enter twice.
 5. In the Changes have been saved window, press Enter.
 6. Press F10 to save changes and exit the UEFI BIOS menu.
- If you have not set a supervisor password, contact a Lenovo authorized service provider to have the system management password removed.

FIDO (Fast Identity Online) authentication

Your computer supports FIDO (Fast Identity Online) authentication feature. This feature works as an alternative to password-based authentication to achieve passwordless authentication. This feature only works when a power-on password is set in UEFI BIOS and the FIDO2 USB device is registered in ThinkShield™ Passwordless Power-On Device Manager. With this feature, you can input the power-on password or use the registered FIDO2 USB device to power on your computer.

Register your FIDO2 USB device in ThinkShield Passwordless Power-On Device Manager

1. Turn on the computer.
2. Press F12 during the power-on process.
3. If you set a power-on password, you are prompted to enter the correct password.
4. Select **App Menu → ThinkShield Passwordless Power-On Device Manager** and press Enter.

5. Insert the FIDO2 USB device to register the device by following steps:
 - a. Select the available FIDO2 USB device that you want to register in the **Discovered Devices** field.
 - b. Click **Yes** in the displayed window to confirm the device you selected.
 - c. If you set a power-on password, you are prompted to enter the correct password.
 - d. The **User operation request** window is displayed. You are prompted to press the button on the connected FIDO2 USB device, and then follow the on-screen instruction to close the window.
 - e. Press Esc to exit and restart your computer.

Notes:

- If you want to unregister your devices, click the available FIDO2 USB device that you want to unregister in the **My Device** field and enter the correct power-on password for verification.
- If you use more than one FIDO2 USB device with a common identifier for registration, only one device is available.

Log in to the System with Passwordless Power-On Authentication

1. Restart the computer.
2. **ThinkShield Passwordless Power-On Authentication** window is displayed.
3. Insert your registered FIDO2 USB device for detection.
4. Then follow the on-screen instruction to press the button on your FIDO2 USB device for verification.
5. After your device is verified, the power-on process continues.

Note: You should insert the FIDO2 USB device or enter the power-on password within 60 seconds. Otherwise, your computer will shut down automatically.

Chapter 5. Configure advanced settings

UEFI BIOS

UEFI BIOS is the first program that the computer runs. When the computer turns on, UEFI BIOS performs a self test to make sure that various devices in the computer are functioning.

Enter the UEFI BIOS menu

Restart the computer. When the logo screen is displayed, press F1 to enter the UEFI BIOS menu.

Navigate in the UEFI BIOS interface

You can navigate in the UEFI BIOS interface by pressing the following keys:

- F1: General Help
- F9: Setup Defaults
- F10: Save and Exit
- F5 / F6: Change boot priority order
- ↑ ↓ or PgUp / PgDn: Select / Scroll page
- ← →: Move keyboard focus
- Esc: Back / Close dialog
- Enter: Select / Open submenu

Set the system date and time

1. Restart the computer. When the logo screen is displayed, press F1.
2. Select **Date/Time** and set the system date and time as desired.
3. Press F10 to save changes and exit.

Change the startup sequence

1. Restart the computer. When the logo screen is displayed, press F1.
2. Select **Startup → Boot**. Then, press Enter. The default device order list is displayed.

Note: No bootable device is displayed if the computer cannot start from any devices or the operating system cannot be found.

3. Set the startup sequence as desired.
4. Press F10 to save the changes and exit.

To change the startup sequence temporarily:

1. Restart the computer. When the logo screen is displayed, press F12.
2. Select the device that you want the computer to start from and press Enter.

View UEFI BIOS Event logs

The UEFI BIOS Event log viewer provides the brief information about UEFI BIOS events. Do the following to view the logs:

1. Restart the computer. When the logo screen is displayed, press F1.

2. Select **Main → BIOS Event log**. Then, press Enter. The UEFI BIOS Event log interface is displayed.
3. Navigate the interface by pressing the following keys, and then check details by selecting each item.
 - ↑↓: Move keyboard focus
 - PgUp / PgDn: Scroll page
 - Enter: Select
 - F3: Exit

The following UEFI BIOS event logs might be listed on your screen depending on UEFI BIOS activities. Each log consists of a date, a time, and a description of the event.

- **Power On** event: This log shows the Power On Self Test (POST) routine has started with the power-on process. It includes the power-on reason, the boot mode, and the shutdown reason.
- **Subcomponent Code Measurement** event: This log shows the subcomponent code measurement has worked. It includes the validation result of each component.
- **System Preboot Authentication** event: This log shows what credential is provided to gain preboot authentication. It includes the installed password, the password type, the input device, and the authentication result.
- **BIOS Password Change** event: This log shows the change history of the UEFI BIOS passwords. It includes the password type, the type and result of the event.
- **Subcomponent Self-healing** event: This log shows the information about the subcomponent where the recovery event occurred. It includes the cause and result of the event, and the recovered firmware version.
- **BIOS Setup Configuration Change** event: This log shows the change history of the UEFI BIOS Setup configuration. It includes the item name and value.
- **Device Change** event: This log shows the change history of devices. It includes the cause and type of the event.
- **System Boot** event: This log shows which device was utilized to boot the system. It includes the boot option, the description, and the file path list.
- **System Tamper** event: This log shows the occurrence of system tamper events. It includes the cause and type of the event.
- **POST Error** event: This log shows the occurrence of errors during the POST routine. It includes the error code.
- **Flash Update** event: This log shows the occurrence of flash update. It includes the cause and result of the event, and the updated firmware version.
- **Set On-Premise** event: This log shows the change history of on-premise boot settings. It includes the value of on-premise settings and the change method.
- **Capsule Update** event: This log shows the occurrence of UEFI capsule firmware update. It includes the cause and result of the event, and the updated firmware version.
- **Log Cleared** event: This log shows UEFI BIOS event logs are cleared. It includes the cause and result of the event.
- **Shutdown / Reboot** event: This log shows the UEFI BIOS is successfully shut down or the system is rebooted. It includes the cause and type of the event.

Customize BIOS Defaults (for Intel models only)

The feature provides a solution to backup your preferred BIOS Setup settings. It helps you to save the BIOS Setup settings as customized BIOS default settings, load them to current BIOS settings when needed, and reset the settings to Setup Defaults.

Save the customized settings configuration

1. Restart the computer. When the logo screen is displayed, press F1 to enter the UEFI BIOS menu.
2. Select **Restart → Save Custom Defaults**.
3. Click **Yes** to save the settings configuration you customized.

Load the customized settings configuration

1. Restart the computer. When the logo screen is displayed, press F1 to enter the UEFI BIOS menu.
2. Select **Restart → Load Custom Defaults**.
3. Click **Yes** to load the customized settings configuration you saved.

You can also press F9 and click **Custom Defaults** to load the customized settings configuration.

Note: **Load Custom Defaults** is unavailable if no customized BIOS default settings are saved.

Reset the settings configuration to Setup Defaults

1. Restart the computer. When the logo screen is displayed, press F1 to enter the UEFI BIOS menu.
2. Select **Restart → Load Factory Defaults**.
3. Click **Yes** to reset the settings configuration to Setup Defaults.

You can also press F9 and click **Factory Defaults** to reset the settings configuration to Setup Defaults.

Reset system to factory defaults

This feature allows you to reset the UEFI BIOS to the factory default settings, including all UEFI BIOS settings and internal data. It helps you wipe user data in case that you want to dispose of or reuse your computer.

1. Restart the computer. When the logo screen is displayed, press F1 to enter the UEFI BIOS menu.
2. Select **Security → Reset System to Factory Defaults** and press Enter.
3. Several warning windows might be displayed. Do the following before resetting the system to the factory default settings:
 - a. Deactivate the Absolute Persistence Module.
 - b. Remove the NVMe password if your have set one.
4. For computer models with RAID settings, a window is displayed to remind you of data damage. Select **Yes** to proceed.
5. A window is displayed to confirm all UEFI BIOS settings will be reset. Select **Yes** to proceed.

Note: If the **Intel AMT control** and **Absolute Persistence(R) Module** are permanently disabled, these settings cannot be reset successfully.

6. Enter the supervisor password, system management password or power-on password in the window prompted.

Your computer will restart immediately. It takes a few minutes to complete the initialization process. Your computer screen might be blank during this process. This is normal and you should not interrupt it.

Update UEFI BIOS

When you install a new program, device driver, or hardware component, you might need to update UEFI BIOS.

Download and install the latest UEFI BIOS update package by one of the following methods:

- Open the Vantage app to check the available update packages. If the latest UEFI BIOS update package is available, follow the on-screen instructions to download and install the package.
- Go to <https://pcsupport.lenovo.com> and select the entry for your computer. Then, follow the on-screen instructions to download and install the latest UEFI BIOS update package.

To know more about UEFI BIOS, visit Knowledge Base of your computer at <https://pcsupport.lenovo.com>.

Cloud bare metal recovery (for selected models)

This feature enables you to remove all user files on your computer and restore the Windows operating system from Cloud (Microsoft® Connected System Recovery). Before using this feature, read the following information.

Notes:

- This feature will restore your computer to the Windows operating system preinstalled at the factory. Do not use this feature if a customized operating system is installed on your computer, otherwise the customized functions or applications cannot be restored.
- This feature only works with wired network (connected via the Ethernet connector on your computer) and wireless network (WPA2 personal only).

Do the following to restore the Windows operating system:

1. Restart the computer. When the logo screen is displayed, press F1 to enter the UEFI BIOS menu.
2. Select **Config → Reinstall Windows from Cloud**. Follow the on-screen instructions to enable this feature.
3. Press F10 to save changes and exit.
4. The computer will restart automatically. When the logo screen is displayed, press F12.
5. Select **App Menu → Reinstall Windows from Cloud**, and then follow the on-screen instructions.

If the recovery process fails, you still have other options to restore the Windows operating system. For more information, refer to “Self-help resources” on page 55.

Install a Windows operating system and drivers

This section provides instructions on installing a Windows operating system and device drivers.

Install a Windows operating system

Microsoft® constantly makes updates to the Windows operating system. Before installing a particular Windows version, check the compatibility list for the Windows version. For details, go to <https://support.lenovo.com/us/en/solutions/windows-support>.

Attention:

- It is recommended that you update your operating system through official channels. Any unofficial update might cause security risks.
 - The process of installing a new operating system deletes all the data on your internal storage drive, including the data stored in a hidden folder.
1. If you are using the Windows BitLocker® Drive Encryption feature and your computer has a Trusted Platform Module, ensure that you have disabled the feature.
 2. Ensure that the security chip is set to **Active**.
 - a. Restart the computer. When the logo screen is displayed, press F1 to enter the UEFI BIOS menu.

- b. Select **Security** → **Security Chip** and press Enter. The **Security Chip** submenu opens.
 - c. Ensure that the security chip for TPM 2.0 is set to **Active**.
 - d. Press F10 to save the settings and exit.
3. Connect the drive that contains the operating system installation program to the computer.
 4. Restart the computer. When the logo screen is displayed, press F1 to enter the UEFI BIOS menu.
 5. Select **Startup** → **Boot** to display the **Boot Priority Order** submenu.
 6. Select the drive that contains the operating system installation program, for example, **USB HDD**. Then, press Esc.

Attention: After you change the startup sequence, ensure that you select the correct device during a copy, a save, or a format operation. If you select the wrong device, the data on that device might be erased or overwritten.

7. Select **Restart** and ensure that **OS Optimized Defaults** is enabled. Then, press F10 to save the settings and exit.
8. Follow the on-screen instructions to install the device drivers and necessary programs.
9. After installing the device drivers, apply Windows Update to get the latest updates, for example the security patches.

Install device drivers

You should download the latest driver for a component when you notice poor performance from that component or when you added a component. This action might eliminate the driver as the potential cause of a problem. Download and install the latest driver by one of the following methods:

- Open the Vantage app to check the available update packages. Select the update packages you want, and then follow the on-screen instructions to download and install the packages.
- Go to <https://pcsupport.lenovo.com> and select the entry for your computer. Then, follow the on-screen instructions to download and install necessary drivers and software.

Install device drivers

You should download the latest driver for a component when you notice poor performance from that component or when you added a component. This action might eliminate the driver as the potential cause of a problem. Download and install the latest driver by one of the following methods.

- Open the Vantage app to check the available update packages. Select the update packages you want, and then follow the on-screen instructions to download and install the packages.
- Go to <https://pcsupport.lenovo.com> and select the entry for your computer. Then, follow the on-screen instructions to download and install necessary drivers and software.
- Apply Windows Update to get the latest updates, such as the security patches. Then, follow the on-screen instructions to download and install the necessary updates.

Chapter 6. CRU replacement

Customer Replaceable Units (CRUs) are parts that can be replaced by the customer. The computers contain the following types of CRUs:

- **Self-service CRUs:** Refer to parts that can be replaced easily by customer themselves or by trained service technicians at an additional cost.
- **Optional-service CRUs:** Refer to parts that can be replaced by customers with a greater skill level. Trained service technicians can also provide service to replace the parts under the type of warranty designated for the customer's machine.

If you intend on installing a CRU, Lenovo will ship the CRU to you. CRU information and replacement instructions are shipped with your product and are available from Lenovo at any time upon request. You might be required to return the defective part that is replaced by the CRU. When return is required: (1) return instructions, a prepaid shipping label, and a container will be included with the replacement CRU; and (2) you might be charged for the replacement CRU if Lenovo does not receive the defective CRU within thirty (30) days of your receipt of the replacement CRU. For full details, see the Lenovo Limited Warranty documentation at https://www.lenovo.com/warranty/llw_02.

CRU list

The following is a list of CRUs of your computer.

Self-service CRUs

- ac power adapter*
- Base cover assembly
- Memory module*
- Memory module bracket
- M.2 solid-state drive
- Power cord*
- Speaker assembly (for ThinkPad E16 Gen 1 only)

* for selected models

Note: Replacement of any parts not listed above, including the built-in rechargeable battery, should be done by a qualified repair technician or by ensuring that you carefully follow all instructions provided by Lenovo. You can also find Lenovo-authorized repair facilities by going to <https://support.lenovo.com/partnerlocator> for more information.

Disable Fast Startup and the built-in battery

Before replacing any CRU, ensure that you disable Fast Startup first and then disable the built-in battery.

To disable Fast Startup:

1. Go to **Control Panel** and view by Large icons or Small icons.
2. Click **Power Options**, and then click **Choose what the power buttons do** on the left pane.
3. Click **Change settings that are currently unavailable** at the top.
4. If prompted by User Account Control (UAC), click **Yes**.

5. Clear the **Turn on fast startup** check box, and then click **Save changes**.

To disable the built-in battery:

1. Restart your computer. When the logo screen is displayed, immediately press F1 to enter the UEFI BIOS menu.
2. Select **Config → Power**. The **Power** submenu is displayed.
3. Select **Disable Built-in Battery** and press Enter.
4. Select **Yes** in the Setup Confirmation window. The built-in battery is disabled and the computer turns off automatically. Wait three to five minutes to let the computer cool.

Replace a CRU

Follow the replacement procedure to replace a CRU.

Base cover assembly

Prerequisite

Before you start, read [Generic Safety and Compliance Notices](#) and print the following instructions.

Note: Do not remove the base cover assembly when your computer is connected to ac power. Otherwise, there might be a risk of short circuits.

For access, do the following:

1. Disable the built-in battery. See “Disable Fast Startup and the built-in battery” on page 43.
2. Turn off the computer and disconnect the computer from ac power and all connected cables.
3. Close the computer display and turn over the computer.

Removal procedure

ThinkPad E14 Gen 5

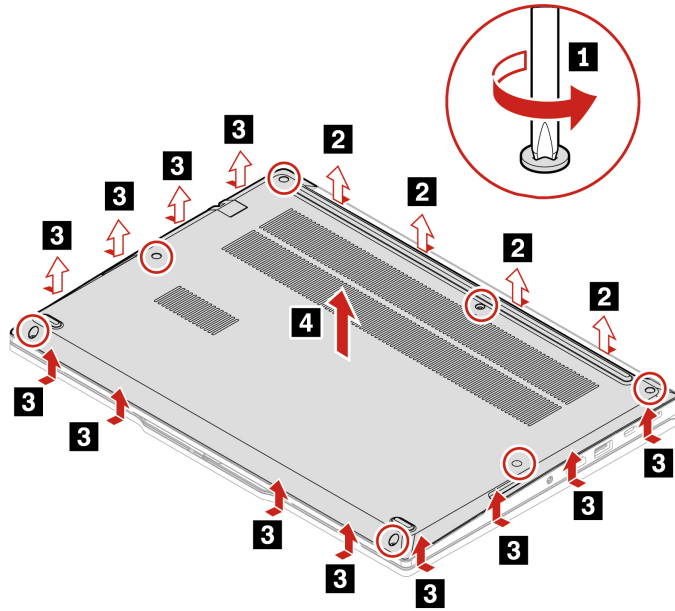

ThinkPad E16 Gen 1

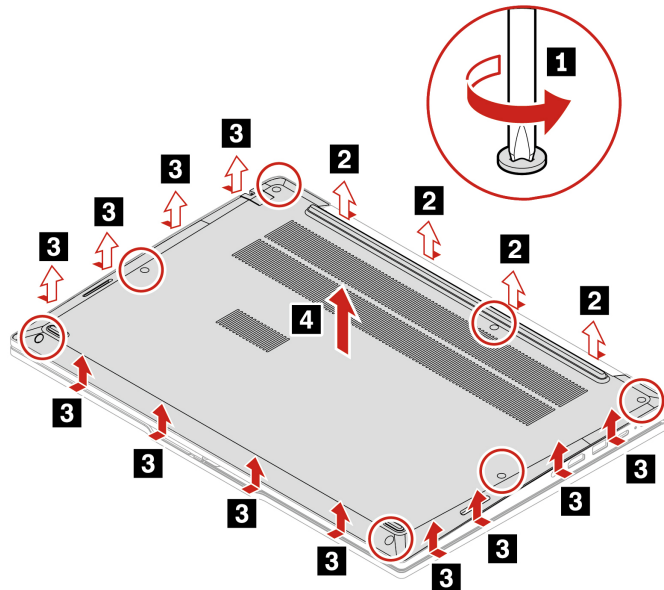

Troubleshooting

If the computer does not start up after you reinstall the base cover assembly, disconnect the ac power adapter and then reconnect it to the computer.

Memory module (for selected models)

Prerequisite

Before you start, read [Generic Safety and Compliance Notices](#) and print the following instructions.

Attention: Do not touch the contact edge of the memory module. Otherwise, the memory module might get damaged.

For access, do the following:

1. Disable the built-in battery. See “Disable Fast Startup and the built-in battery” on page 43.
2. Turn off the computer and disconnect the computer from ac power and all connected cables.
3. Close the computer display and turn the computer over.
4. Remove the base cover assembly. See “Base cover assembly” on page 44.

Removal procedure

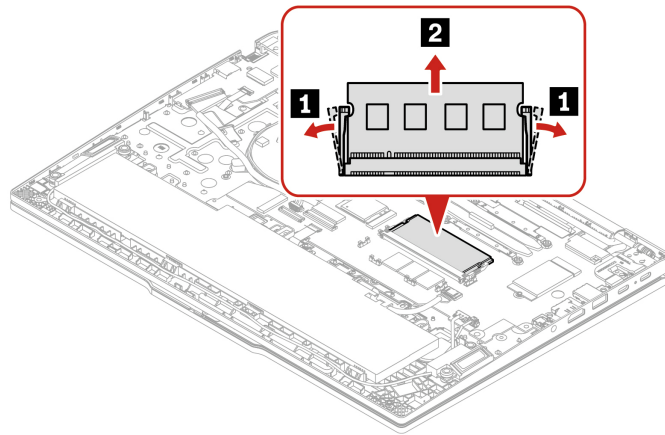
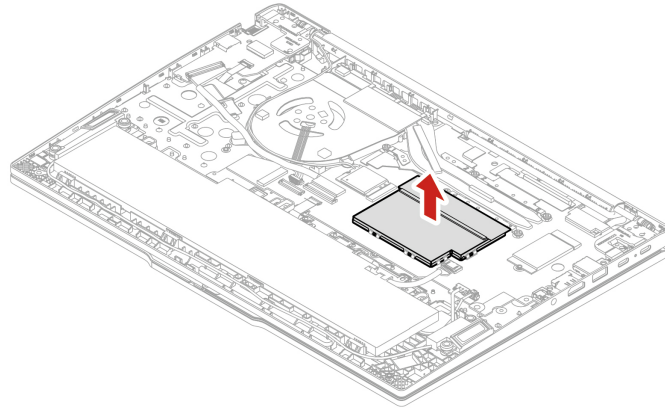

Installation procedure

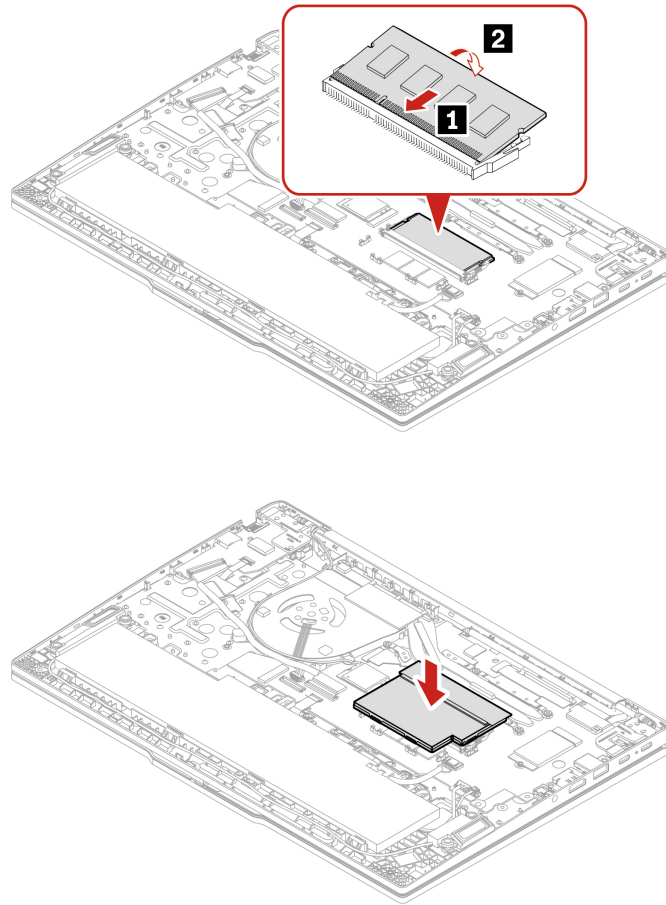

M.2 solid-state drive

Prerequisite

Before you start, read [Generic Safety and Compliance Notices](#) and print the following instructions.

Attention: If you replace a M.2 solid-state drive, you might need to install a new operating system. For details on how to install a new operating system, see “Install a Windows operating system and drivers” on page 40.

The M.2 solid-state drive is sensitive. Inappropriate handling might cause damage and permanent loss of data.

When handling the M.2 solid-state drive, observe the following guidelines:

- Replace the M.2 solid-state drive only for repair. The M.2 solid-state drive is not designed for frequent changes or replacement.
- Before replacing the M.2 solid-state drive, make a backup copy of all the data that you want to keep.
- Do not apply pressure to the M.2 solid-state drive.
- Do not touch the contact edge or circuit board of the M.2 solid-state drive. Otherwise, the M.2 solid-state drive might get damaged.

- Do not make the M.2 solid-state drive subject to physical shocks or vibration. Put the M.2 solid-state drive on a soft material, such as cloth, to absorb physical shocks.

For access, do the following:

1. Disable the built-in battery. See “Disable Fast Startup and the built-in battery” on page 43.
2. Turn off the computer and disconnect the computer from ac power and all connected cables.
3. Close the computer display and turn the computer over.
4. Remove the base cover assembly. See “Base cover assembly” on page 44.

Removal procedure

Intel models

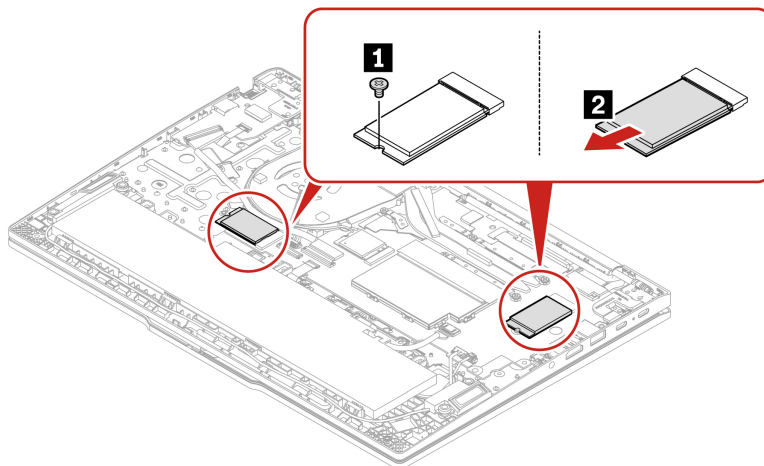

AMD models

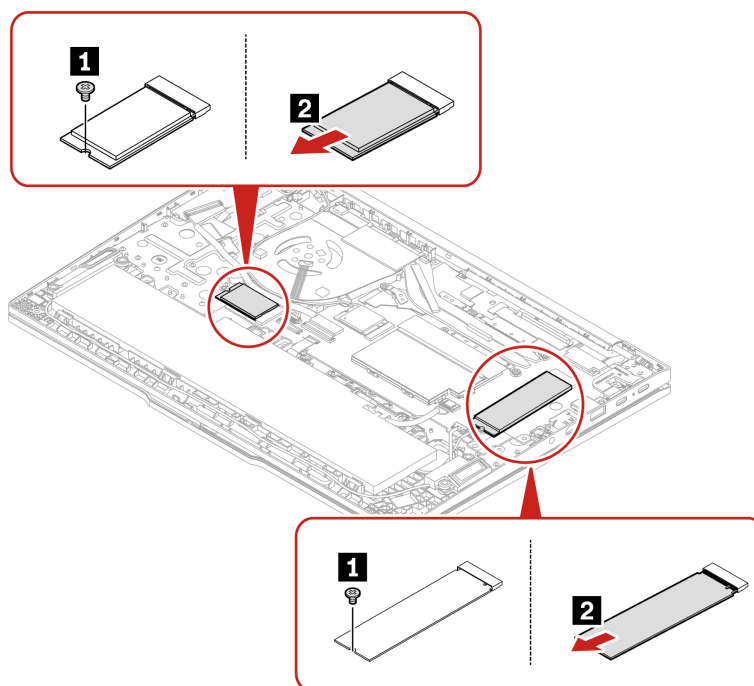

Speaker assembly (for ThinkPad E16 Gen 1 Only)

Prerequisite

Before you start, read [Generic Safety and Compliance Notices](#) and print the following instructions.

For access, do the following:

1. Disable the built-in battery. See “Disable Fast Startup and the built-in battery” on page 43.
2. Turn off the computer and disconnect the computer from ac power and all connected cables.
3. Close the computer display and turn the computer over.
4. Remove the base cover assembly. See “Base cover assembly” on page 44.

Removal procedure

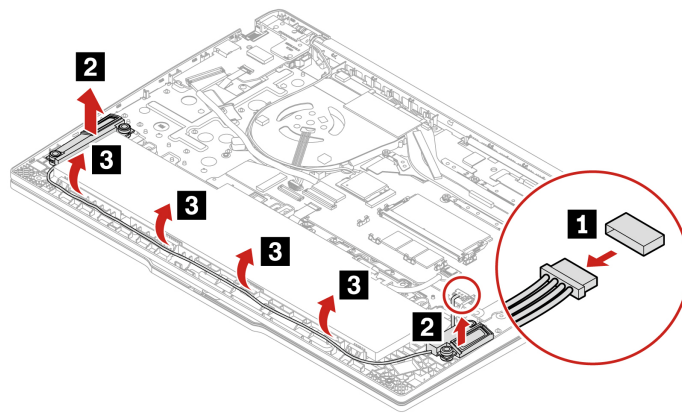

Chapter 7. Help and support

Frequently asked questions

Question	Solution
How do I access Control Panel ?	Type Control Panel in the Windows search box and then press Enter.
How do I turn off my computer?	Open the Start menu and click  Power . Then, click Shut down .
How do I partition my storage drive?	https://support.lenovo.com/solutions/ht503851
What do I do if my computer stops responding?	<ol style="list-style-type: none">1. Press and hold the power button until the computer turns off. Then, restart the computer.2. If step 1 does not work:<ul style="list-style-type: none">• For models with an emergency reset hole: Insert a straightened paper clip into the emergency reset hole to cut off power supply temporarily. Then, restart the computer with ac power connected.• For models without an emergency reset hole:<ul style="list-style-type: none">– For models with the removable battery, remove the removable battery and disconnect all power sources. Then, reconnect to ac power and restart the computer.– For models with the built-in battery, disconnect all power sources. Press and hold the power button for about seven seconds. Then, reconnect to ac power and restart the computer.
What do I do if I spill liquid on the computer?	<ol style="list-style-type: none">1. Carefully unplug the ac power adapter and turn off the computer immediately. The more quickly you stop the current from passing through the computer the more likely you will reduce damage from short circuits. Attention: Although you might lose some data or work by turning off the computer immediately, leaving the computer on might make your computer unusable.2. Do not try to drain out the liquid by turning over the computer. If your computer has keyboard drainage holes on the bottom, the liquid will be drained out through the holes.3. Wait until you are certain that all the liquid is dry before turning on your computer.
How do I enter the UEFI BIOS menu?	Restart the computer. When the logo screen is displayed, press F1 to enter the UEFI BIOS menu.

Question	Solution
Where can I get the latest device drivers and UEFI BIOS?	<ul style="list-style-type: none">• From the Vantage app. See “Install a Windows operating system and drivers” on page 40 and “Update UEFI BIOS” on page 39.• Download from Lenovo Support Web site at https://pcsupport.lenovo.com.
What do I do if the LCD goes black when I turn on the computer?	<p>To run LCD Self-Test:</p> <ol style="list-style-type: none">1. Ensure that the computer is connected to the ac power adapter.2. Press the power button for about seven seconds to turn off the computer.3. Press Fn, left Ctrl, and the power button at the same time. If the computer displays five solid colors in sequence across the entire screen, it indicates that the LCD functions normally.4. The test lasts for about 20 seconds and then exits automatically. You also can press the power button to exit the test.

Error messages

If you see a message that is not included in the following table, record the error message first, then shut down the computer and call Lenovo for help. See “Lenovo Customer Support Center” on page 57.

Message	Solution
0190: Critical low-battery error	The computer turned off because the battery power is low. Connect the ac power adapter to the computer and charge the batteries.
0191: System Security - Invalid remote change requested	The system configuration change has failed. Confirm the operation and try again.
0199: System Security - Security password retry count exceeded.	This message is displayed when you enter a wrong supervisor password more than three times. Confirm the supervisor password and try again.
0271: Check Date and Time settings.	The date or the time is not set in the computer. Enter the UEFI BIOS menu and set the date and time.
210x/211x: Detection/Read error on HDDx/SSDx	The storage drive is not working. Reinstall the storage drive. If the problem still exists, replace the storage drive.
Error: The non-volatile system UEFI variable storage is nearly full.	<p>Note: This error indicates that the operating system or programs cannot create, modify, or delete data in the non-volatile system UEFI variable storage due to insufficient storage space after POST.</p> <p>The non-volatile system UEFI variable storage is used by the UEFI BIOS and by the operating system or programs. This error occurs when the operating system or programs store large amounts of data in the variable storage. All data needed for POST, such as UEFI BIOS setup settings, chipset, or platform configuration data, are stored in a separate UEFI variable storage. Press F1 after the error message is displayed to enter the UEFI BIOS menu. A dialog asks for confirmation to clean up the storage. If you select “Yes”, all data that were created by the operating system or programs will be deleted except global variables defined by the Unified Extensible Firmware Interface Specification. If you select “No”, all data will be kept, but the operating system or programs will not be able to create, modify, or delete data in the storage.</p> <p>If this error happens at a service center, Lenovo authorized service personnel will clean up the non-volatile system UEFI variable storage using the preceding solution.</p>

Beep errors

Lenovo SmartBeep technology enables you to decode beep errors with your smartphone when a black screen occurs with beeps from your computer. To decode the beep error with Lenovo SmartBeep technology:

1. Go to <https://support.lenovo.com/smartbeep> or scan the following QR Code.



2. Download the proper diagnostic app and install it on your smartphone.
3. Run the diagnostic app and place the smartphone near the computer.
4. Press Fn on your computer to emit the beep again. The diagnostic app decodes the beep error and shows possible solutions on the smartphone.

Note: We recommend that you speak to our Customer Support Center before attempting to service the computer yourself so that you can be directed to the correct documentation and repair information. It might be recommended to have a Lenovo-authorized service provider repair your computer depending on the complexity of the error or fault.

Self-help resources

Use the following self-help resources to learn more about the computer and troubleshoot problems.

Resources	How to access?
Troubleshooting and FAQ	<ul style="list-style-type: none">• https://www.lenovo.com/tips• https://forums.lenovo.com
Accessibility information	https://www.lenovo.com/accessibility
Reset or restore Windows	<ul style="list-style-type: none">• Use Lenovo recovery options.<ol style="list-style-type: none">1. Go to https://support.lenovo.com/HowToCreateLenovoRecovery.2. Follow the on-screen instructions.• Use Windows recovery options.<ol style="list-style-type: none">1. Go to https://pcsupport.lenovo.com.2. Detect your computer or manually select your computer model.3. Navigate to the troubleshooting menu to diagnose the operating system for recovery instructions.
Use the Vantage app to: <ul style="list-style-type: none">• Configure device settings.• Download and install UEFI BIOS, drivers, and firmware updates.• Secure your computer from outside threats.• Diagnose hardware problems.• Check the computer warranty status.• Access <i>User Guide</i> and helpful articles.	Type Vantage in the Windows search box and then press Enter.
Note: The available features vary depending on the computer model.	
Product documentation: <ul style="list-style-type: none">• <i>Safety and Warranty Guide</i>• <i>Generic Safety and Compliance Notices</i>• <i>Setup Guide</i>• <i>This User Guide</i>• <i>Regulatory Notice</i>	Go to https://pcsupport.lenovo.com . Then, follow the on-screen instructions to filter out the documentation you want.

Resources	How to access?
<p>Lenovo Support Web site with the latest support information of the following:</p> <ul style="list-style-type: none"> • Drivers and software • Diagnostic solutions • Product and service warranty • Product and parts details • Knowledge base and frequently asked questions 	<p>https://pcsupport.lenovo.com</p>
<p>Windows help information</p>	<ul style="list-style-type: none"> • Open the Start menu and click Get Help. • Use Windows Search or the Cortana® personal assistant. • Microsoft support Web site: https://support.microsoft.com

Windows label

Your computer might have a Windows Genuine Microsoft label affixed to its cover depending on the following factors:

- Your geographic location
- Edition of Windows that is preinstalled

Go to <https://www.microsoft.com/howtotell/Hardware.aspx> for illustrations of the various types of Genuine Microsoft labels.

- In the People's Republic of China, the Genuine Microsoft label is required on all computer models preinstalled with any edition of the Windows operating system.
- In other countries and regions, the Genuine Microsoft label is required only on computer models licensed for Windows Pro editions.

The absence of a Genuine Microsoft label does not indicate that the preinstalled Windows version is not genuine. For details on how to tell whether your preinstalled Windows product is genuine, refer to the information provided by Microsoft at <https://www.microsoft.com/howtotell/default.aspx>.

There are no external, visual indicators of the Product ID or Windows version for which the computer is licensed. Instead, the Product ID is recorded in the computer firmware. Whenever a Windows product is installed, the installation program checks the computer firmware for a valid, matching Product ID to complete the activation.

In some cases, an earlier Windows version might be preinstalled under the terms of the Windows Pro edition license downgrade rights.

Call Lenovo

If you have tried to correct the problem yourself and still need help, you can call Lenovo Customer Support Center.

Before you contact Lenovo

Prepare the following before you contact Lenovo:

1. Record the problem symptoms and details:

- What is the problem? Is it continuous or intermittent?
- Any error message or error code?
- What operating system are you using? Which version?
- Which software applications were running at the time of the problem?
- Can the problem be reproduced? If so, how?

2. Record the system information:

- Product name
- Machine type and serial number

The following illustration shows where to find the machine type and serial number of your computer.

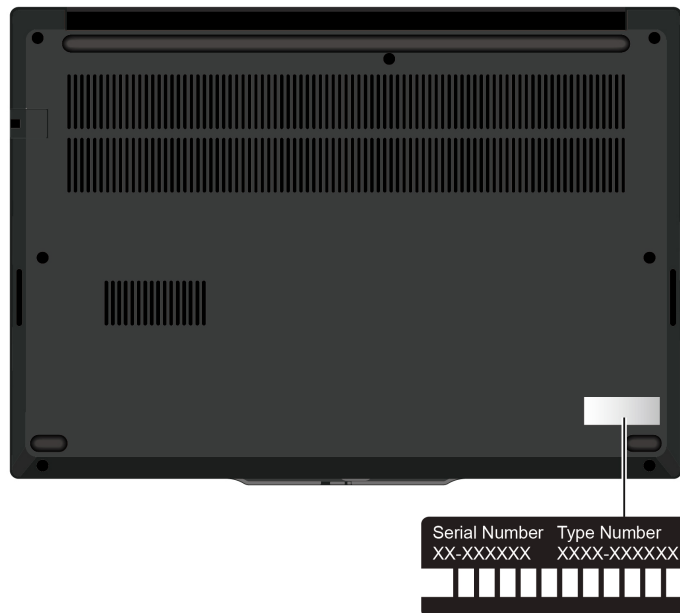

Lenovo Customer Support Center

During the warranty period, you can call Lenovo Customer Support Center for help.

Telephone numbers

For a list of the Lenovo Support phone numbers for your country or region, go to <https://pcsupport.lenovo.com/supportphonenumber> for the latest phone numbers.

Note: Phone numbers are subject to change without notice. If the number for your country or region is not provided, contact your Lenovo reseller or Lenovo marketing representative.

Services available during the warranty period

- Problem determination - Trained personnel are available to assist you with determining if you have a hardware problem and deciding what action is necessary to fix the problem.
- Lenovo hardware repair - If the problem is determined to be caused by Lenovo hardware under warranty, trained service personnel are available to provide the applicable level of service.
- Engineering change management - Occasionally, there might be changes that are required after a product has been sold. Lenovo or your reseller, if authorized by Lenovo, will make selected Engineering Changes (ECs) that apply to your hardware available.

Services not covered

- Replacement or use of parts not manufactured for or by Lenovo or nonwarranted parts
- Identification of software problem sources
- Configuration of UEFI BIOS as part of an installation or upgrade
- Changes, modifications, or upgrades to device drivers
- Installation and maintenance of network operating systems (NOS)
- Installation and maintenance of programs

For the terms and conditions of the Lenovo Limited Warranty that apply to your Lenovo hardware product, go to:

- https://www.lenovo.com/warranty/llw_02
- <https://pcsupport.lenovo.com/warrantylookup>

Purchase additional services

During and after the warranty period, you can purchase additional services from Lenovo at <https://pcsupport.lenovo.com/warrantyupgrade>.

Service availability and service name might vary by country or region.

Appendix A. Compliance information

For compliance information, refer to *Regulatory Notice* at <https://pcsupport.lenovo.com> and *Generic Safety and Compliance Notices* at https://pcsupport.lenovo.com/docs/generic_notices.

CAUTION:

When the computer is operating, it should be placed on a hard and flat surface with its bottom area not in contact with user's bare skin. Under normal operating conditions, the temperature of the bottom surface will remain within an acceptable range as defined in IEC 62368-1, but such temperatures can still be high enough to cause discomfort or harm to the user if directly touched for over one minute at a time. As such, it is recommended that users avoid prolonged direct contact with the bottom of the computer.

Certification-related information

Product name	Compliance ID	Machine type(s)
ThinkPad E14 Gen 5	<ul style="list-style-type: none">• Intel models:<ul style="list-style-type: none">– TP00148B– TP00148B0¹– TP00148B1¹• AMD models:<ul style="list-style-type: none">– TP00148A– TP00148A0¹	<ul style="list-style-type: none">• Intel models: 21JK and 21JL• AMD models: 21JR and 21JS
ThinkPad E16 Gen 1	<ul style="list-style-type: none">• Intel models:<ul style="list-style-type: none">– TP00149B– TP00149B0¹– TP00149B1¹• AMD models:<ul style="list-style-type: none">– TP00149A– TP00149A0¹	<ul style="list-style-type: none">• Intel models: 21JN and 21JQ• AMD models: 21JT and 21JU
ThinkPad R14 Gen 5 ²	<ul style="list-style-type: none">• TP00148B• TP00149B0• TP00148B1	21JM

¹ for India only / ² for mainland China only

Further compliance information related to your product is available at <https://www.lenovo.com/compliance>.

Locate the UltraConnect wireless antennas

Your computer has an UltraConnect™ wireless antenna system. You can enable wireless communication wherever you are.

The following illustration shows the antenna locations on your computer:

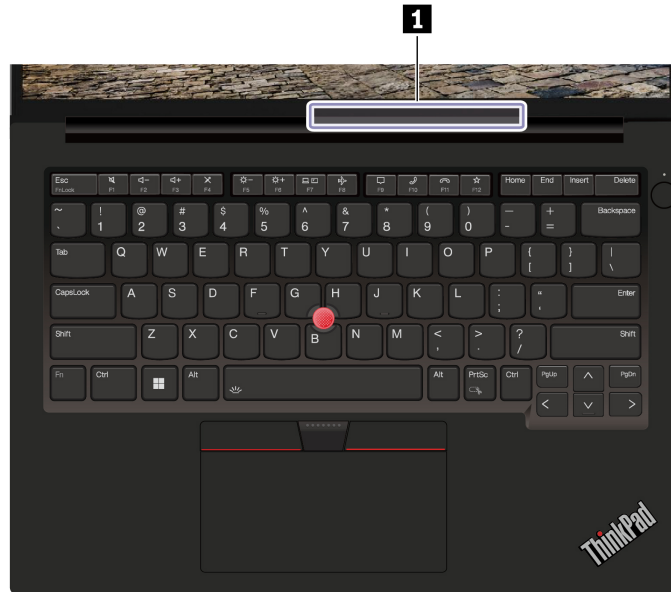

1 Wireless LAN antenna

Operating environment

Maximum altitude (without pressurization)

3048 m (10 000 ft)

Temperature

- Operating: 5°C to 35°C (41°F to 95°F)
- Storage and transportation in original shipping packaging: -20°C to 60°C (-4°F to 140°F)
- Storage without packaging: 5°C to 43°C (41°F to 109°F)

Note: When you charge the battery, its temperature must be no lower than 10°C (50°F).

Relative humidity

- Operating: 8% to 95% at wet-bulb temperature 23°C (73°F)
- Storage and transportation: 5% to 95% at wet-bulb temperature 27°C (81°F)

Appendix B. Notices and trademarks

Notices

Lenovo may not offer the products, services, or features discussed in this document in all countries. Consult your local Lenovo representative for information on the products and services currently available in your area. Any reference to a Lenovo product, program, or service is not intended to state or imply that only that Lenovo product, program, or service may be used. Any functionally equivalent product, program, or service that does not infringe any Lenovo intellectual property right may be used instead. However, it is the user's responsibility to evaluate and verify the operation of any other product, program, or service.

Lenovo may have patents or pending patent programs covering subject matter described in this document. The furnishing of this document does not give you any license to these patents. You can send license inquiries, in writing, to:

*Lenovo (United States), Inc.
8001 Development Drive
Morrisville, NC 27560
U.S.A.
Attention: Lenovo Director of Licensing*

LENOVO PROVIDES THIS PUBLICATION "AS IS" WITHOUT WARRANTY OF ANY KIND, EITHER EXPRESS OR IMPLIED, INCLUDING, BUT NOT LIMITED TO, THE IMPLIED WARRANTIES OF NON-INFRINGEMENT, MERCHANTABILITY OR FITNESS FOR A PARTICULAR PURPOSE. Some jurisdictions do not allow disclaimer of express or implied warranties in certain transactions, therefore, this statement may not apply to you.

Changes are made periodically to the information herein; these changes will be incorporated in new editions of the publication. To provide better service, Lenovo reserves the right to improve and/or modify the products and software programs described in the manuals included with your computer, and the content of the manual, at any time without additional notice.

The software interface and function and hardware configuration described in the manuals included with your computer might not match exactly the actual configuration of the computer that you purchase. For the configuration of the product, refer to the related contract (if any) or product packing list, or consult the distributor for the product sales. Lenovo may use or distribute any of the information you supply in any way it believes appropriate without incurring any obligation to you.

The products described in this document are not intended for use in implantation or other life support applications where malfunction may result in injury or death to persons. The information contained in this document does not affect or change Lenovo product specifications or warranties. Nothing in this document shall operate as an express or implied license or indemnity under the intellectual property rights of Lenovo or third parties. All information contained in this document was obtained in specific environments and is presented as an illustration. The result obtained in other operating environments may vary.

Lenovo may use or distribute any of the information you supply in any way it believes appropriate without incurring any obligation to you.

Any references in this publication to non-Lenovo Web sites are provided for convenience only and do not in any manner serve as an endorsement of those Web sites. The materials at those Web sites are not part of the materials for this Lenovo product, and use of those Web sites is at your own risk.

Any performance data contained herein was determined in a controlled environment. Therefore, the result obtained in other operating environments may vary significantly. Some measurements may have been made on development-level systems and there is no guarantee that these measurements will be the same on generally available systems. Furthermore, some measurements may have been estimated through extrapolation. Actual results may vary. Users of this document should verify the applicable data for their specific environment.

This document is copyrighted by Lenovo and is not covered by any open source license, including any Linux® agreement(s) which may accompany software included with this product. Lenovo may update this document at any time without notice.

For the latest information or any questions or comments, contact or visit the Lenovo Web site:

<https://pcsupport.lenovo.com>

Trademarks

Lenovo, Lenovo logo, ThinkPad, ThinkPad logo, and TrackPoint are trademarks of Lenovo. Intel, Intel Optane, and Thunderbolt are trademarks of Intel Corporation or its subsidiaries in the U.S. and/or other countries. Linux is the registered trademark of Linus Torvalds in the U.S. and other countries. Microsoft, Microsoft Teams, Windows, BitLocker, and Cortana are trademarks of the Microsoft group of companies. Dolby, Dolby Voice and Dolby Atmos are trademarks of Dolby Laboratories Licensing Corporation. The terms HDMI and HDMI High-Definition Multimedia Interface are trademarks or registered trademarks of HDMI Licensing LLC in the United States and other countries. USB-C is a registered trademark of USB Implementers Forum. Wi-Fi and Miracast are registered trademarks of Wi-Fi Alliance. All other trademarks are the property of their respective owners.