

ThinkPad®

P70 User Guide

ThinkPad

Lenovo

Note: Before using this information and the product it supports, ensure that you read and understand the following:

- *Safety and Warranty Guide*
- *Setup Guide*
- “Important safety information” on page v

Lenovo makes constant improvement on the documentation of your computer, including this *User Guide*. To get all the latest documents, go to:

<https://support.lenovo.com>

Depending on the version of operating systems, some user interface instructions might not be applicable to your computer.

Eighth Edition (March 2019)

© Copyright Lenovo 2015, 2019.

LIMITED AND RESTRICTED RIGHTS NOTICE: If data or software is delivered pursuant to a General Services Administration “GSA” contract, use, reproduction, or disclosure is subject to restrictions set forth in Contract No. GS-35F-05925.

Contents

Important safety information v

Read this first.	v
Important information about using your computer	v
Conditions that require immediate action	vii
Service and upgrades	viii
Power cords and power adapters	ix
Extension cords and related devices.	ix
Plugs and outlets	x
Power supply statement	x
External devices	xi
General battery notice	xi
Notice for removable rechargeable battery	xi
Notice for non-rechargeable coin-cell battery	xii
Heat and product ventilation	xiii
Electrical current safety information	xiv
Laser safety information	xv
Liquid crystal display (LCD) notice	xv
Using headphones or earphones	xv
Choking hazard notice	xvi
Plastic bag notice	xvi
Glass parts notice	xvi

Chapter 1. Product overview 1

Computer controls, connectors, and indicators	1
Front view	1
Left-side view	2
Right-side view	4
Rear view	6
Bottom view	7
Status indicators	7
Important product information	9
Machine type and model label	9
FCC ID and IC Certification information	10
Labels for the Windows operating systems	10
Computer features.	11
Specifications	13
Operating environment	13
Lenovo programs	14
Accessing Lenovo programs	14
An introduction to Lenovo programs	14

Chapter 2. Using your computer 17

Registering your computer	17
Frequently asked questions	17
Using the multi-touch screen	18
Using the special keys	20
Using the ThinkPad pointing device	22

ThinkPad pointing device overview	22
Using the TrackPoint pointing device.	23
Using the trackpad with buttons	24
Using the trackpad touch gestures	25
Customizing the ThinkPad pointing device	25
Replacing the cap on the pointing stick	26
Power management	26
Using the ac power adapter	26
Using the battery	27
Managing the battery power	28
Power-saving modes	28
Ethernet connections	29
Wireless connections	29
Using the wireless-LAN connection	30
Using the wireless-WAN connection	30
Using the Bluetooth connection.	31
Using audio features	31
Using the camera	32
Using the color sensor	32
Using an ExpressCard, a media card, or a smart card	33
Using an external display	35
Traveling with your computer	36

Chapter 3. Enhancing your computer. 39

Finding ThinkPad options	39
ThinkPad Pen Pro	39
ThinkPad Workstation Dock	41
ThinkPad Workstation Dock overview	41
Attaching the docking station to your computer	42
Detaching the docking station from your computer	43
Guideline on connecting multiple external displays to the docking station	45

Chapter 4. Accessibility, ergonomic, and maintenance information 47

Accessibility information	47
Ergonomic information	49
Cleaning and maintenance	50

Chapter 5. Security 53

Using passwords	53
Passwords introduction	53
Setting, changing, or removing a password	54
Hard disk security	55

Setting the security chip	56
Using the fingerprint reader	56
Deleting data from your storage drive	58
Using firewalls	59
Protecting data against viruses	59

Chapter 6. Advanced configuration 61

Installing a new operating system	61
Installing a Windows 7 operating system	61
Installing a Windows 10 operating system	62
Installing device drivers	63
Using the ThinkPad Setup program	64
Configuring ThinkPad Setup	64
Changing the startup sequence	65
Updating the UEFI BIOS	65
BIOS menu	66
Using system management	81

Chapter 7. Configuring RAID 83

Storage drive requirements for RAID levels	83
Configuring RAID with the Intel RST configuration utility	83
Entering the Intel RST configuration utility	84
Creating RAID volumes	84
Deleting RAID volumes	85
Resetting storage drives to non-RAID	85
Rebuilding RAID 1 volumes	86

Chapter 8. Troubleshooting computer problems 87

General tips for preventing problems	87
Diagnosing problems	87
Troubleshooting	88
Computer stops responding	88
Spills on the keyboard	89
Error messages	89
Beep errors	91
Memory module problems	92
Wireless-LAN problem	93
Wireless-WAN problem	93
Bluetooth problem	93
ThinkPad pointing device problems	94
Keyboard problems	94
Computer screen problems	95
External monitor problems	97
Audio problems	98
Fingerprint reader problems	99
Battery problems	100
ac power adapter problem	100
Power problems	100

Power button problem	101
Boot problems	101
Sleep and hibernation problems	101
Hard disk drive problems	102
Solid-state drive problem	103
ThinkPad Pen Pro problem	103
Software problem	103
USB problem	103
Docking station problem	103

Chapter 9. Recovery information . . .105

Recovery information for the Windows 7 operating system	105
Creating and using recovery media	105
Reinstalling preinstalled programs and device drivers	106
Recovery information for the Windows 10 operating system	107
Resetting your computer	107
Using advanced startup options	107
Recovering your operating system if Windows 10 fails to start	107
Creating and using a recovery USB drive	107

Chapter 10. Replacing devices109

Static electricity prevention	109
Replacing the removable battery	109
Installing or replacing the micro SIM card	111
Replacing the bottom cover	112
Replacing the optical drive	113
Replacing the wireless-WAN card	114
Replacing the M.2 solid-state drive	117
Replacing the keyboard	120
Replacing the coin-cell battery	123
Replacing the hard disk drive under the bottom cover	126
Replacing the hard disk drive in the optical drive bay	127
Replacing the memory module under the bottom cover	130
Replacing the memory module under the keyboard	131

Chapter 11. Getting support.135

Before you contact Lenovo	135
Getting help and service	135
Lenovo Support Web site	136
Calling Lenovo	136
Purchasing additional services	137

Appendix A. Supplemental information about the Ubuntu operating system139

Appendix B. Regulatory information.141

Appendix C. WEEE and recycling statements of countries and regions147

Appendix D. Restriction of Hazardous Substances (RoHS) Directive of countries and regions.151

Appendix E. ENERGY STAR model information.155

Appendix F. Notices157

Appendix G. Trademarks159

Important safety information

Note: Read the important safety information first.

Read this first

This information can help you safely use your notebook computer. Follow and retain all information included with your computer. The information in this document does not alter the terms of your purchase agreement or the Limited Warranty. For more information, see "Warranty Information" in the *Safety and Warranty Guide* that comes with your computer.

Customer safety is important. Our products are developed to be safe and effective. However, personal computers are electronic devices. Power cords, power adapters, and other features can create potential safety risks that can result in physical injury or property damage, especially if misused. To reduce these risks, follow the instructions included with your product, observe all warnings on the product and in the operating instructions, and review the information included in this document carefully. By carefully following the information contained in this document and provided with your product, you can help protect yourself from hazards and create a safer computer work environment.

Note: This information includes references to power adapters and batteries. In addition to notebook computers, some products (such as speakers and monitors) ship with external power adapters. If you have such a product, this information applies to your product. In addition, computer products contain a coin-sized internal battery that provides power to the system clock even when the computer is unplugged, so the battery safety information applies to all computer products.

Important information about using your computer

Ensure that you follow the important tips given here to get the most use and enjoyment out of your computer. Failure to do so might lead to discomfort or injury, or cause the computer to fail.

Protect yourself from the heat that your computer generates.



When your computer is turned on or the battery is charging, the base, the palm rest, and some other parts may become hot. The temperature they reach depends on the amount of system activity and the level of charge in the battery.

Extended contact with your body, even through clothing, could cause discomfort or even a skin burn.

- Avoid keeping your hands, your lap, or any other part of your body in contact with a hot section of the computer for any extended time.
- Periodically take hands from using the keyboard by lifting your hands from the palm rest.

Protect yourself from the heat generated by the ac power adapter.



When the ac power adapter is connected to an electrical outlet and your computer, it generates heat.

Extended contact with your body, even through clothing, may cause a skin burn.

- Do not place the ac power adapter in contact with any part of your body while it is in use.
- Never use it to warm your body.
- Do not wrap the cords around the ac power adapter while in use.

Prevent your computer from getting wet.



To avoid spills and the danger of electrical shock, keep liquids away from your computer.

Protect the cables from being damaged.

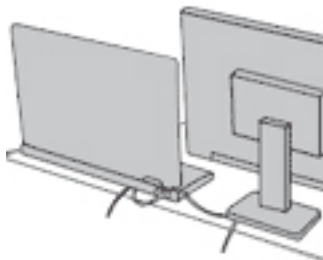

Applying strong force to cables may damage or break them.

Route communication lines, or the cables of an ac power adapter, a mouse, a keyboard, a printer, or any other electronic device, so that they cannot be walked on, tripped over, pinched by your computer or other objects, or in any way subject to treatment that could interfere with the operation of your computer.

Protect your computer and data when moving it.



Before moving a computer equipped with a hard disk drive, do one of the following:

- Turn it off.
- Put it in sleep mode.
- Put it in hibernation mode.

This helps to prevent damage to the computer, and possible loss of data.

Handle your computer gently.

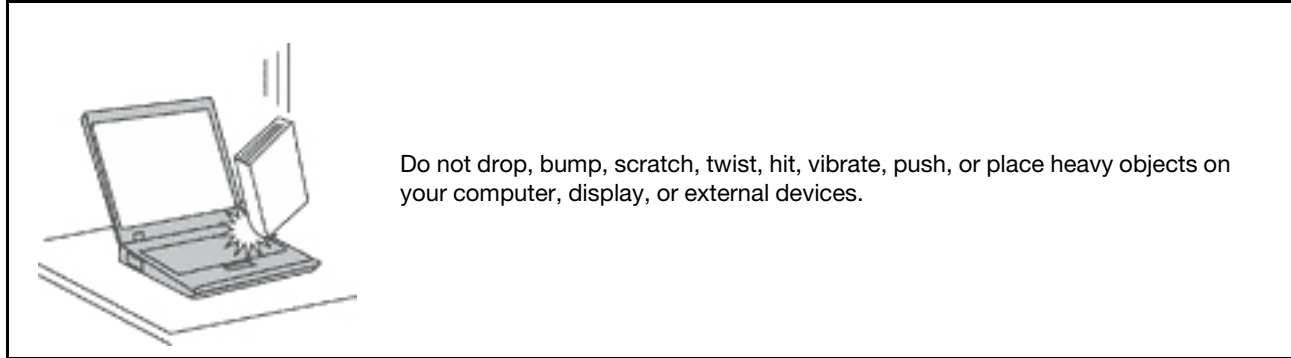

Carry your computer carefully.

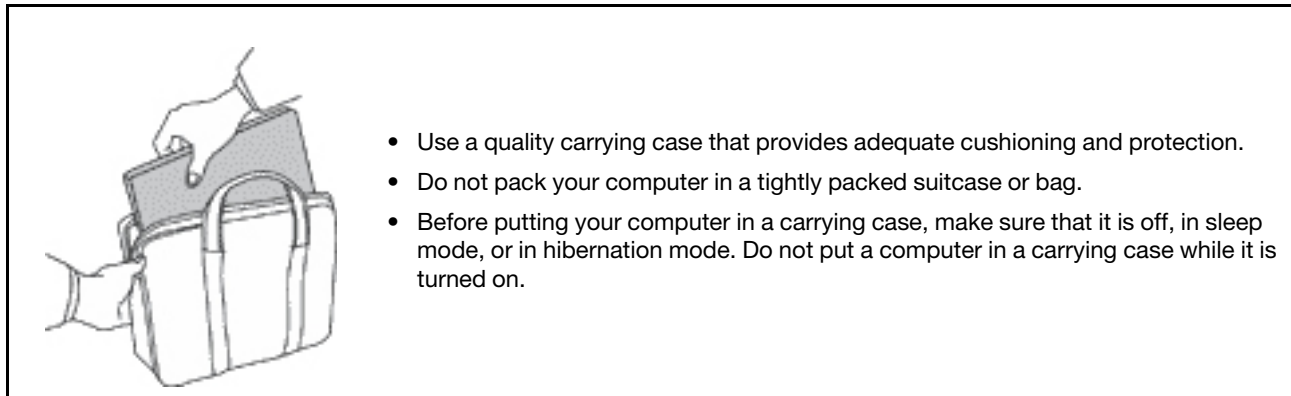

Conditions that require immediate action

Products can become damaged due to misuse or neglect. Some product damage is serious enough that the product should not be used again until it has been inspected and, if necessary, repaired by an authorized servicer.

As with any electronic device, pay close attention to the product when it is turned on. On very rare occasions, you might notice an odor or see a puff of smoke or sparks vent from your product. Or you might hear sounds like popping, cracking, or hissing. These conditions might merely mean that an internal electronic component has failed in a safe and controlled manner. Or, they might indicate a potential safety issue. However, do not take risks or attempt to diagnose the situation yourself. Contact the Customer Support Center for further guidance. For a list of Service and Support phone numbers, see the following Web site:

<https://pcsupport.lenovo.com/supportphonenumberlist>

Frequently inspect your computer and its components for damage or wear or signs of danger. If you have any question about the condition of a component, do not use the product. Contact the Customer Support Center or the product manufacturer for instructions on how to inspect the product and have it repaired, if necessary.

In the unlikely event that you notice any of the following conditions, or if you have any safety concerns with your product, stop using the product and unplug it from the power source and telecommunication lines until you can speak to the Customer Support Center for further guidance.

- Power cords, plugs, power adapters, extension cords, surge protectors, or power supplies that are cracked, broken, or damaged.
- Signs of overheating, smoke, sparks, or fire.
- Damage to a battery (such as cracks, dents, or creases), discharge from a battery, or a buildup of foreign substances on the battery.
- A cracking, hissing, or popping sound, or strong odor that comes from the product.
- Signs that liquid has been spilled or an object has fallen onto the computer product, the power cord, or power adapter.
- The computer product, power cord, or power adapter has been exposed to water.
- The product has been dropped or damaged in any way.
- The product does not operate normally when you follow the operating instructions.

Note: If you notice these conditions with a product (such as an extension cord) that is not manufactured for or by Lenovo®, stop using that product until you can contact the product manufacturer for further instructions, or until you get a suitable replacement.

Service and upgrades

Do not attempt to service a product yourself unless instructed to do so by the Customer Support Center or your documentation. Only use a Service Provider who is approved to repair your particular product.

Note: Some computer parts can be upgraded or replaced by the customer. Upgrades typically are referred to as options. Replacement parts approved for customer installation are referred to as Customer Replaceable Units, or CRUs. Lenovo provides documentation with instructions when it is appropriate for customers to install options or replace CRUs. You must closely follow all instructions when installing or replacing parts. The Off state of a power indicator does not necessarily mean that voltage levels inside a product are zero. Before you remove the covers from a product equipped with a power cord, always make sure that the power is turned off and that the product is unplugged from any power source. If you have any questions or concerns, contact the Customer Support Center.

Although there are no moving parts in your computer after the power cord has been disconnected, the following warnings are required for your safety.



CAUTION:
Hazardous moving parts. Keep fingers and other body parts away.

CAUTION:



Before you open the computer cover, turn off the computer and wait several minutes until the computer is cool.

Power cords and power adapters



Use only the power cords and power adapters supplied by the product manufacturer.

The power cords shall be safety approved. For Germany, it shall be H03VV-F, 3G, 0.75 mm², or better. For other countries, the suitable types shall be used accordingly.

Never wrap a power cord around a power adapter or other object. Doing so can stress the cord in ways that can cause the cord to fray, crack, or crimp. This can present a safety hazard.

Always route power cords so that they will not be walked on, tripped over, or pinched by objects.

Protect power cords and power adapters from liquids. For instance, do not leave your power cord or power adapter near sinks, tubs, toilets, or on floors that are cleaned with liquid cleansers. Liquids can cause a short circuit, particularly if the power cord or power adapter has been stressed by misuse. Liquids also can cause gradual corrosion of power cord terminals and/or the connector terminals on a power adapter, which can eventually result in overheating.

Ensure that all power cord connectors are securely and completely plugged into receptacles.

Do not use any power adapter that shows corrosion at the ac input pins or shows signs of overheating (such as deformed plastic) at the ac input pins or anywhere on the power adapter.

Do not use any power cords where the electrical contacts on either end show signs of corrosion or overheating or where the power cord appears to have been damaged in any way.

To prevent possible overheating, do not cover the power adapter with clothing or other objects when the power adapter is plugged into an electrical outlet.

Extension cords and related devices

Ensure that extension cords, surge protectors, uninterruptible power supplies, and power strips that you use are rated to handle the electrical requirements of the product. Never overload these devices. If power strips are used, the load should not exceed the power strip input rating. Consult an electrician for more information if you have questions about power loads, power requirements, and input ratings.

Plugs and outlets



If a receptacle (power outlet) that you intend to use with your computer equipment appears to be damaged or corroded, do not use the outlet until it is replaced by a qualified electrician.

Do not bend or modify the plug. If the plug is damaged, contact the manufacturer to obtain a replacement.

Do not share an electrical outlet with other home or commercial appliances that draw large amounts of electricity; otherwise, unstable voltage might damage your computer, data, or attached devices.

Some products are equipped with a three-pronged plug. This plug fits only into a grounded electrical outlet. This is a safety feature. Do not defeat this safety feature by trying to insert it into a non-grounded outlet. If you cannot insert the plug into the outlet, contact an electrician for an approved outlet adapter or to replace the outlet with one that enables this safety feature. Never overload an electrical outlet. The overall system load should not exceed 80 percent of the branch circuit rating. Consult an electrician for more information if you have questions about power loads and branch circuit ratings.

Be sure that the power outlet you are using is properly wired, easily accessible, and located close to the equipment. Do not fully extend power cords in a way that will stress the cords.

Be sure that the power outlet provides the correct voltage and current for the product you are installing.

Carefully connect and disconnect the equipment from the electrical outlet.

Power supply statement



Never remove the cover on a power supply or any part that has the following label attached.



Hazardous voltage, current, and energy levels are present inside any component that has this label attached. There are no serviceable parts inside these components. If you suspect a problem with one of these parts, contact a service technician.

External devices

CAUTION:

Do not connect or disconnect any external device cables other than Universal Serial Bus (USB) and 1394 cables while the computer power is on; otherwise, you might damage your computer. To avoid possible damage to attached devices, wait at least five seconds after the computer is shut down to disconnect external devices.

General battery notice



Batteries supplied by Lenovo for use with your product have been tested for compatibility and should only be replaced with approved parts. A battery other than the one specified by Lenovo, or a disassembled or modified battery is not covered by the warranty.

Battery abuse or mishandling can cause overheating, liquid leakage, or an explosion. To avoid possible injury, do the following:

- Do not open, disassemble, or service any battery.
- Do not crush or puncture the battery.
- Do not short-circuit the battery, or expose it to water or other liquids.
- Keep the battery away from children.
- Keep the battery away from fire.

Stop using the battery if it is damaged, or if you notice any discharge or the buildup of foreign materials on the battery leads.

Store the rechargeable batteries or products containing the rechargeable batteries at room temperature, charged to approximately 30 to 50% of capacity. We recommend that the batteries be charged about once per year to prevent overdischarge.

Do not put the battery in trash that is disposed of in landfills. When disposing of the battery, comply with local ordinances or regulations.

Notice for removable rechargeable battery



Only recharge the battery strictly according to instructions included in the product documentation.

If the battery is incorrectly replaced, there is danger of an explosion. The battery contains a small amount of harmful substances.

Notice for non-rechargeable coin-cell battery



If the coin-cell battery is incorrectly replaced, there is danger of an explosion. The battery contains a small amount of harmful substance.

Do not heat to more than 100°C (212°F).

The following statement applies to users in the state of California, U.S.A.

California Perchlorate Information:

Products containing manganese dioxide lithium coin-cell batteries may contain perchlorate.

Perchlorate Material - special handling may apply, See <https://www.dtsc.ca.gov/hazardouswaste/perchlorate/>

Heat and product ventilation



Computers, ac power adapters, and many accessories can generate heat when turned on and when batteries are charging. Notebook computers can generate a significant amount of heat due to their compact size. Always follow these basic precautions:

- When your computer is turned on or the battery is charging, the base, the palm rest, and some other parts may become hot. Avoid keeping your hands, your lap, or any other part of your body in contact with a hot section of the computer for any extended length of time. When you use the keyboard, avoid keeping your palms on the palm rest for a prolonged period of time. Your computer generates some heat during normal operation. The amount of heat depends on the amount of system activity and the battery charge level. Extended contact with your body, even through clothing, could cause discomfort or even a skin burn. Periodically take breaks from using the keyboard by lifting your hands from the palm rest; and be careful not to use the keyboard for any extended length of time.
- Do not operate your computer or charge the battery near flammable materials or in explosive environments.
- Ventilation slots, fans and/or heat sinks are provided with the product for safety, comfort, and reliable operation. These features might inadvertently become blocked by placing the product on a bed, sofa, carpet, or other flexible surface. Never block, cover, or disable these features.
- When the ac power adapter is connected to an electrical outlet and your computer, it generates heat. Do not place the adapter in contact with any part of your body while using it. Never use the ac power adapter to warm your body. Extended contact with your body, even through clothing, may cause a skin burn.

For your safety, always follow these basic precautions with your computer:

- Keep the cover closed whenever the computer is plugged in.
- Regularly inspect the outside of the computer for dust accumulation.
- Remove dust from vents and any perforations in the bezel. More frequent cleanings might be required for computers in dusty or high-traffic areas.
- Do not restrict or block any ventilation openings.
- Do not operate your computer inside furniture, as this might increase the risk of overheating.
- Airflow temperatures into the computer should not exceed 35°C (95°F).

Electrical current safety information



Electric current from power, telephone, and communication cables is hazardous.

To avoid a shock hazard:

- Do not use your computer during a lightning storm.
- Do not connect or disconnect any cables or perform installation, maintenance, or reconfiguration of this product during an electrical storm.
- Connect all power cords to a properly wired and grounded electrical outlet.
- Connect to properly wired outlets any equipment that will be attached to this product.
- Whenever possible, use one hand only to connect or disconnect signal cables.
- Never turn on any equipment when there is evidence of fire, water, or structural damage.
- Disconnect the attached power cords, battery, and all the cables before you open the device covers, unless instructed otherwise in the installation and configuration procedures.
- Do not use your computer until all internal parts enclosures are fastened into place. Never use the computer when internal parts and circuits are exposed.



Connect and disconnect cables as described in the following procedures when installing, moving, or opening covers on this product or attached devices.

To connect:

1. Turn everything OFF.
2. First, attach all cables to devices.
3. Attach signal cables to connectors.
4. Attach power cords to outlets.
5. Turn devices ON.

To disconnect:

1. Turn everything OFF.
2. First, remove power cords from outlets.
3. Remove signal cables from connectors.
4. Remove all cables from devices.

The power cord must be disconnected from the wall outlet or receptacle before installing all other electrical cables connected to the computer.

The power cord may be reconnected to the wall outlet or receptacle only after all other electrical cables have been connected to the computer.



During electrical storms, do not perform any replacement and do not connect the telephone cable to or disconnect it from the telephone outlet on the wall.

Laser safety information



CAUTION:

When laser products (such as CD-ROMs, DVD drives, fiber optic devices, or transmitters) are installed, note the following:

- Do not remove the covers. Removing the covers of the laser product could result in exposure to hazardous laser radiation. There are no serviceable parts inside the device.
- Use of controls or adjustments or performance of procedures other than those specified herein might result in hazardous radiation exposure.



DANGER

Some laser products contain an embedded Class 3B laser diode. Note the following:
Laser radiation when open. Do not stare into the beam, do not view directly with optical instruments, and avoid direct exposure to the beam.

Liquid crystal display (LCD) notice

CAUTION:

The liquid crystal display (LCD) is made of glass, and rough handling or dropping the computer can cause the LCD to break. If the LCD breaks and the internal fluid gets into your eyes or on your hands, immediately wash the affected areas with water for at least 15 minutes; if any symptoms are present after washing, get medical care.

Note: For products with mercury-containing fluorescent lamps (for example, non-LED), the fluorescent lamp in the liquid crystal display (LCD) contains mercury; dispose of according to local, state, or federal laws.

Using headphones or earphones

CAUTION:

Excessive sound pressure from earphones and headphones can cause hearing loss. Adjustment of the equalizer to maximum increases the earphone and headphone output voltage and the sound pressure level. Therefore, to protect your hearing, adjust the equalizer to an appropriate level.

Excessive use of headphones or earphones for a long period of time at high volume can be dangerous if the output of the headphone or earphone connectors do not comply with specifications of EN 50332-2. The headphone output connector of your computer complies with EN 50332-2 Sub clause 7. This specification limits the computer's maximum wide band true RMS output voltage to 150 mV. To help protect against hearing loss, ensure that the headphones or earphones you use also comply with EN 50332-2 (Clause 7 limits) for a wide band characteristic voltage of 75 mV. Using headphones that do not comply with EN 50332-2 can be dangerous due to excessive sound pressure levels.

If your Lenovo computer came with headphones or earphones in the package, as a set, the combination of the headphones or earphones and the computer already complies with the specifications of EN 50332-1. If different headphones or earphones are used, ensure that they comply with EN 50332-1 (Clause 6.5 Limitation Values). Using headphones that do not comply with EN 50332-1 can be dangerous due to excessive sound pressure levels.

Choking hazard notice



CHOKING HAZARD – Product contains small parts.

Keep away from children under three years.

Plastic bag notice



Plastic bags can be dangerous. Keep plastic bags away from babies and children to avoid danger of suffocation.

Glass parts notice

CAUTION:

Some parts of your product may be made of glass. This glass could break if the product is dropped on a hard surface or receives a substantial impact. If glass breaks, do not touch or attempt to remove it. Stop using your product until the glass is replaced by trained service personnel.

Chapter 1. Product overview

This chapter provides basic information to help you get familiar with your computer.

Computer controls, connectors, and indicators

This section introduces hardware features of the computer.

Front view



Figure 1. Front view

1 Camera (available on some models)	2 Microphones
3 Screen (multi-touch screen on some models)	4 Power button
5 Numeric keypad	6 Fingerprint reader
7 TrackPoint® pointing device	8 Trackpad with buttons
9 Color sensor (available on some models)	10 Speakers

1 Camera (available on some models)

Use the camera to take pictures or hold a video conference. For more information, see “Using the camera” on page 32.

2 Microphones

The microphones capture sound and voice when used with a program capable of handling audio.

3 Screen (multi-touch screen on some models)

The multi-touch screen enables you to use your computer with simple touch gestures. For more information, see “Using the multi-touch screen” on page 18.

4 Power button

Press the power button to turn on the computer or put the computer into sleep mode. For information about turning off the computer, see “Frequently asked questions” on page 17.

If your computer is unresponsive, you can turn off the computer by pressing and holding the power button for four or more seconds. If the computer cannot be turned off, see “Computer stops responding” on page 88.

You also can define what the power button does. For example, by pressing the power button, you can turn off the computer or put the computer into sleep or hibernation mode. To change what the power button does, do the following:

1. Go to Control Panel, and then change the view of Control Panel from Category to Large icons or Small icons.
2. Click **Power Options → Choose what the power buttons do**.
3. Follow the instructions on the screen.

5 Numeric keypad

Use the numeric keypad to quickly input numbers.

6 Fingerprint reader

Fingerprint authentication technology provides the simple and secure user access by associating your fingerprint with passwords. For more information, see “Using the fingerprint reader” on page 56.

ThinkPad® pointing device

7 TrackPoint pointing device

8 Trackpad with buttons

The keyboard contains the Lenovo-unique ThinkPad pointing device. For information about using the ThinkPad pointing device, see “Using the ThinkPad pointing device” on page 22.

9 Color sensor (available on some models)

The color sensor enables you to measure and adjust the color accuracy of your displays. For more information, see “Using the color sensor” on page 32.

10 Speakers

Your computer is equipped with a pair of stereo speakers.

Left-side view

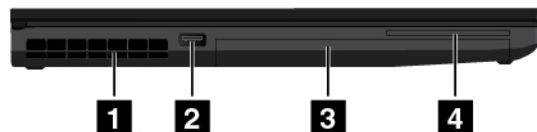

Figure 2. Left-side view

1 Fan louvers	2 Always On USB 3.0 connector
3 Optical drive bay (available on some models)	4 Smart-card slot (available on some models)

1 Fan louvers

The fan louvers and the internal fan enable air to circulate in the computer to ensure proper cooling, especially the cooling of the microprocessor.

Note: To ensure proper airflow, do not place any obstacles in front of the fan louvers.

2 Always On USB 3.0 connector

By default, the Always On USB 3.0 connector enables you to charge the USB-compatible devices in the following situations:

- When your computer is on or in sleep mode
- When your computer is in hibernation mode or is turned off, but connected to ac power

Attention: When you attach a USB cable to this connector, ensure that the USB mark is facing upward. Otherwise the connector might get damaged.

If you want to charge these devices when the computer is in hibernation mode or is turned off, and the computer is not connected to ac power, do the following:

- **For Windows® 7:** Start the Power Manager program, click the **Global Power Settings** tab, and then follow the instructions on the screen.
- **For Windows 10:** Start the Lenovo Vantage program, click **Hardware Settings → Power**. Locate the **Always On USB** section and follow the instructions on the screen to make your preferred setting.

For instructions on how to start the programs, see “Accessing Lenovo programs” on page 14.

3 Optical drive bay (available on some models)

An optical drive or a secondary hard disk drive might be installed in the optical drive bay.

4 Smart-card slot (available on some models)

Smart cards can be used for authentication, data storage, and application processing. Smart cards also might provide strong security authentication for single sign-on (SSO) within large organizations. For more information, see “Using an ExpressCard, a media card, or a smart card” on page 33.

Right-side view



Figure 3. Right-side view

1 Audio connector	2 USB 3.0 connectors
3 Media-card slot	4 ExpressCard slot
5 Mini DisplayPort® connector	6 Fan louvers
7 Security-lock slot	

1 Audio connector

Connect headphones or a headset that has a 3.5-mm (0.14-inch) 4-pole plug to the audio connector to listen to the sound from the computer.

If you are using a headset with a function switch, do not press this switch while using the headset. If you press the switch, the headset microphone is disabled, and the integrated microphones on the computer is enabled instead.

Note: The audio connector does not support a conventional microphone. For more information, see “Using audio features” on page 31.

2 USB 3.0 connectors

The USB 3.0 connectors are used for connecting USB-compatible devices, such as a USB keyboard, a USB mouse, a USB storage device, or a USB printer.

Attention: When you attach a USB cable to this connector, ensure that the USB mark is facing upward. Otherwise the connector might get damaged.

3 Media-card slot

Insert your media card into this slot to read the data on the card. For more information about using the media card, see “Using an ExpressCard, a media card, or a smart card” on page 33.

4 ExpressCard slot

For information about using the ExpressCard slot, see “Using an ExpressCard, a media card, or a smart card” on page 33.

5 Mini DisplayPort connector

Use the Mini DisplayPort connector to connect your computer to a compatible projector, external monitor, or high-definition television. This compact connector enables a plug-and-play setup and supports adapters that can plug into DVI, video graphics array (VGA), or High-Definition Multimedia Interface (HDMI™) connectors. The Mini DisplayPort connector of your computer supports audio as well as video streaming.

6 Fan louvers

The fan louvers and the internal fan enable air to circulate in the computer to ensure proper cooling, especially the cooling of the microprocessor.

Note: To ensure proper airflow, do not place any obstacles in front of the fan louvers.

7 Security-lock slot

To protect your computer from theft, lock your computer to a desk, table, or other fixture through a security cable lock designed to fit the security-lock slot on your computer.

Note: You are responsible for evaluating, selecting, and implementing the locking device and security feature. Lenovo makes no comments, judgments, or warranties about the function, quality, or performance of the locking device and security feature. Cable locks for your product are available from Lenovo at <https://www.lenovoquickpick.com/>.

Rear view

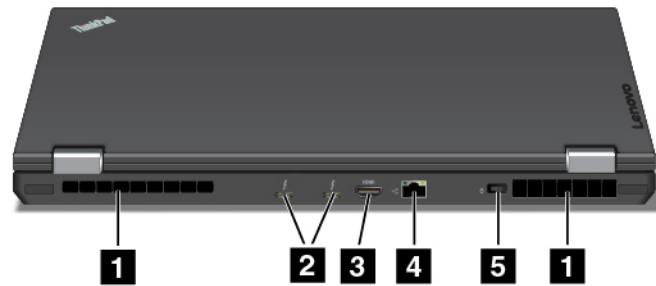

Figure 4. Rear view

1 Fan louvers	2 Thunderbolt™ 3 connectors
3 HDMI connector	4 Ethernet connector
5 Power connector	

1 Fan louvers

The fan louvers and the internal fan enable air to circulate in the computer to ensure proper cooling, especially the cooling of the microprocessor.

Note: To ensure proper airflow, do not place any obstacles in front of the fan louvers.

2 Thunderbolt 3 connectors

The Thunderbolt 3 connector is compatible with USB Type-C standard. It enables you to connect your computer to a device that is compatible with the Thunderbolt 3 interface, such as a projector, an external monitor, or a high-definition television (HDTV). With the Thunderbolt 3 connector, you can transfer data, and run an external display.

3 HDMI connector

HDMI connector is a digital audio and video interface that can connect a compatible digital audio device and video monitor, such as a DVD player or an HDTV.

4 Ethernet connector

Connect the computer to a local area network (LAN) through the Ethernet connector.



DANGER

To avoid the risk of electrical shock, do not connect the telephone cable to the Ethernet connector. You can only connect an Ethernet cable to this connector.

The Ethernet connector has two network status indicators. When the green indicator is on, the computer is connected to a LAN. When the yellow indicator blinks, data is being transmitted.

Note: If the computer is connected to a supported docking station or a supported dock, use the Ethernet connector on the docking station or the dock instead of the one on the computer.

5 Power connector

Connect the computer to ac power through the power connector.

Bottom view

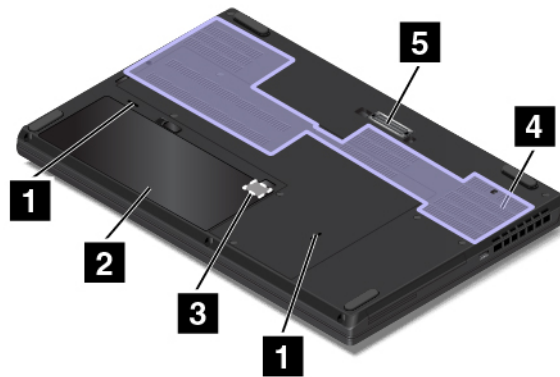

Figure 5. Bottom view

1 Keyboard drainage holes	2 Removable battery
3 Micro-SIM-card slot	4 Fan louvers
5 Docking-station connector	

1 Keyboard drainage holes

If you accidentally spill water or drink over the keyboard, the keyboard drainage holes can help drain out liquid from your computer.

2 Removable battery

Use the computer with battery power whenever ac power is unavailable.

3 Micro-SIM-card slot

The micro-SIM-card slot is in the battery compartment. If the computer has a wireless wide-area-network (WAN) feature, a micro Subscriber Identification Module (SIM) card might be required to establish wireless-WAN connections. For information about replacing or installing the micro SIM card, see “Installing or replacing the micro SIM card” on page 111.

4 Fan louvers

The fan louvers and the internal fan enable air to circulate in the computer to ensure proper cooling, especially the cooling of the microprocessor.

Note: To ensure proper airflow, do not place any obstacles in front of the fan louvers.

5 Docking-station connector

Connect the computer to a supported docking station to extend the computer capabilities when you are at the office or at home. For more information about using the docking stations, see “ThinkPad Workstation Dock” on page 41.

Status indicators

This topic provides information about locating and identifying the various status indicators on your computer.

Note: Your computer might look different from the following illustrations.

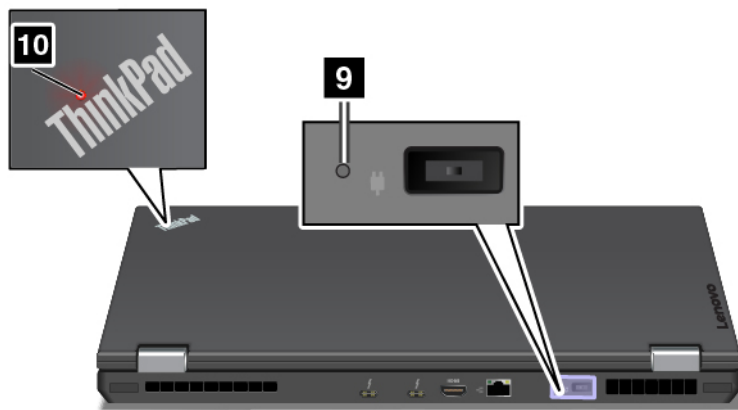
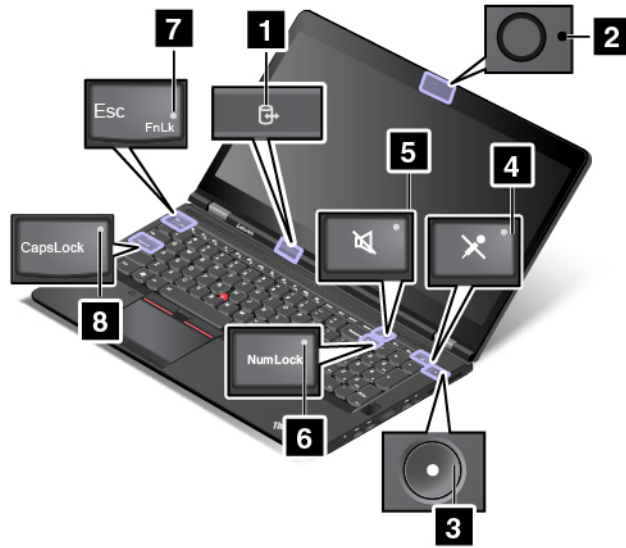

1 Device-access-status indicator

When this indicator is blinking, the storage device of your computer is reading or writing data. During this period, do not put the computer into sleep mode, remove the storage device, or turn off the computer.

2 Camera-status indicator

When this indicator is on, the camera is in use.

3-10 System-status indicators

The indicator in the ThinkPad logo on the computer lid and the indicator in the power button center show the system status of your computer.

- **Blinks for three times:** The computer is initially connected to the power.
- **On:** The computer is on (in normal mode).
- **Off:** The computer is off or in hibernation mode.
- **Blinks fast:** The computer is entering sleep or hibernation mode.
- **Blinks slowly:** The computer is in sleep mode.

Note: If your computer is equipped with a color sensor, the system-status indicator **10** also functions as the color-sensor indicator. For information about the color-sensor indicator, see “Using the color sensor” on page 32.

4 Microphone-mute indicator

When this indicator is on, the microphones are muted.

5 Speaker-mute indicator

When this indicator is on, the speakers are muted.

6 Numeric Lock indicator

When this indicator is on, you can use the numeric keypad to input numbers.

7 Fn Lock indicator

This indicator shows the status of Fn Lock function. For more information about the Fn Lock function, see “Using the special keys” on page 20.

8 Caps Lock indicator

When this indicator is on, you can input uppercase letters directly.

9 ac power status indicator

This indicator shows the ac power charging status of the computer.

- **Green:** connected to ac power (charging 80%–100%)
- **Amber:** connected to ac power (charging 1%–80%)
- **Off:** not connected to ac power (no charging)

Important product information

This section provides information to help you locate the following labels:

- Machine type and model information
- FCC ID and IC Certification information
- Windows operating systems information

Machine type and model label

The machine type and model label identifies your computer. When you contact Lenovo for help, the machine type and model information helps the technicians to identify your computer and provide faster service.

The following figure shows the location of the machine type and model of your computer:



FCC ID and IC Certification information

The FCC and IC Certification information is identified by a label on the computer as shown in the following illustration.

Note: Depending on the model, your computer might look different from the following illustration.

- For a factory-preinstalled wireless module, this label identifies the actual FCC ID and IC certification number for the wireless module installed by Lenovo.

Note: Do not remove or replace a factory-preinstalled wireless module by yourself. For replacement, you must contact Lenovo service first. Lenovo is not responsible for any damage caused by unauthorized replacement.



- For a user-installable wireless WAN module, the actual FCC ID and IC certification number is affixed to the wireless WAN module **1** installed in the computer. To view the FCC ID and IC certification number, you must remove the computer base cover assembly. For instructions, see “Replacing the wireless-WAN card” on page 114.

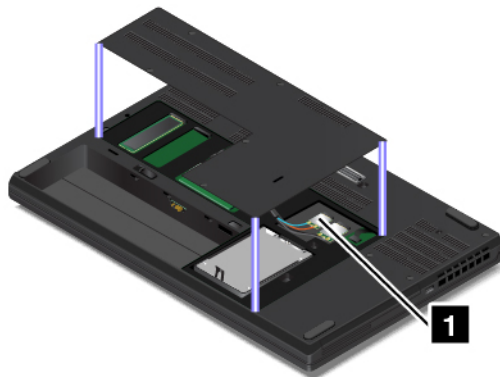

Note: For the user-installable wireless module, ensure that you use only a Lenovo-authorized wireless module specifically tested for this computer model. Otherwise, the computer will generate an error-code beep sequence when you turn on the computer.

Labels for the Windows operating systems

Windows 7 Certificate of Authenticity: Computer models preinstalled with the Windows 7 operating system have a Certificate of Authenticity label affixed to the computer cover or inside the battery compartment. The Certificate of Authenticity is your indication that the computer is licensed for a Windows 7 product and is preinstalled with a Windows 7 genuine version. In some cases, an earlier Windows version might be preinstalled under the terms of the Windows 7 Professional license downgrade rights. Printed on the Certificate of Authenticity is the Windows 7 version for which the computer is licensed and the Product

ID. The Product ID is important when you reinstall the Windows 7 operating system from a source other than a Lenovo product recovery disc set.

Windows 10 Genuine Microsoft® label: Your computer might have a Genuine Microsoft label affixed to its cover depending on the following factors:

- Your geographic location
- Date when your computer was manufactured
- Version of Windows 10 that is preinstalled

Go to <https://www.microsoft.com/en-us/howtotell/Hardware.aspx> for illustrations of the various types of Genuine Microsoft labels.

- In the People's Republic of China, the Genuine Microsoft label is required on all computer models preinstalled with any version of Windows 10.
- In other countries and regions, the Genuine Microsoft label is required only on computer models licensed for Windows 10 Pro.

The absence of a Genuine Microsoft label does not indicate that the preinstalled Windows version is not genuine. For details on how to tell whether your preinstalled Windows product is genuine, refer to the information provided by Microsoft at:

<https://www.microsoft.com/en-us/howtotell/default.aspx>

Unlike Windows 7 products, there are no external, visual indicators of the Product ID or Windows version for which the computer is licensed. Instead, the Product ID is recorded in the computer firmware. Whenever a Windows 10 product is installed, the installation program checks the computer firmware for a valid, matching Product ID to complete the activation.

In some cases, an earlier Windows version might be preinstalled under the terms of the Windows 10 Pro license downgrade rights.

Computer features

The computer features introduced in this section cover various models. For your specific computer model, some features might vary or not apply.

Microprocessor

To view the microprocessor information of your computer, do the following:

- **For Windows 7:** Open the Start menu, right-click **Computer**, and then click **Properties**.
- **For Windows 10:** Right-click the **Start** button and then click **System**.

Memory

- Double data rate 4 (DDR4) small outline dual in-line memory module (SODIMM)
- Error check and correct (ECC) memory module (available on some models)

Storage device

- 2.5-inch form factor, 7-mm (0.28-inch) height hard disk drive
- M.2 solid-state drive (available on some models)

Display

- Brightness control
- Color display with the Thin Film Transistor (TFT) technology
- Display size: 439.42 mm (17.3 inches)
- Display resolution: 1920 x 1080 pixels or 3840 x 2160 pixels
- Multi-touch technology (available on some models)
- NVIDIA Optimus Graphics or discrete graphics

Keyboard

- Six-row keyboard or Six-row backlight keyboard
- Function keys
- Numeric keypad
- ThinkPad pointing device (including TrackPoint pointing device and trackpad with buttons)

Connectors and slots

- ac power connector
- Audio connector
- Docking-station connector
- Ethernet connector
- ExpressCard slot
- Four USB 3.0 connectors (including one Always On USB 3.0 connector)
- HDMI connector
- Media-card slot
- Micro-SIM-card slot (inside the battery compartment)
- Mini DisplayPort connector
- Optical drive bay (available on some models)
- Smart-card slot (available on some models)
- Two Thunderbolt 3 connectors

Security features

- Fingerprint reader
- Security-lock slot

Wireless features

- Bluetooth
- Wireless LAN
- Wireless WAN (available on some models)

Others

- Camera (available on some models)
- Color sensor (available on some models)
- Microphones

Specifications

This section lists the physical specifications for your computer.

Size

- Width: 416 mm (16.4 inches)
- Depth: 275.5 mm (10.8 inches)
- Thickness:
 - Non-touch models: 29.9–34.2 mm (1.18–1.35 inches)
 - Touch models: 30.65–34.95 mm (1.21–1.38 inches)

Heat output (depending on the model)

- 170 W (580 Btu/hr) maximum
- 230 W (786 Btu/hr) maximum

Power source (ac power adapter)

- Sine-wave input at 50 to 60 Hz
- Input rating of the ac power adapter: 100 to 240 V ac, 50 to 60 Hz

Operating environment

Maximum altitude (without pressurization)

- 3048 m (10 000 ft)

Temperature

- At altitudes up to 2438 m (8000 ft)
 - Operating: 5°C to 35°C (41°F to 95°F)
 - Storage: 5°C to 43°C (41°F to 109°F)
- At altitudes above 2438 m (8000 ft)
 - Maximum temperature when operating under the unpressurized condition: 31.3°C (88°F)

Note: When you charge the battery, its temperature must be at least 10°C (50°F).

Relative humidity

- Operating: 8% to 95% at wet-bulb temperature 23°C (73°F)
- Storage: 5% to 95% at wet-bulb temperature 27°C (81°F)

If possible, place your computer in a well-ventilated and dry area without direct exposure to sunshine.

Attention:

- Keep electrical appliances such as electric fans, radio, air conditioners, and microwave ovens away from the computer. The strong magnetic fields generated by these appliances can damage the monitor and data on the internal storage drive.
- Do not place any beverages on top of or beside the computer or other attached devices. If liquid is spilled on or in the computer or an attached device, a short circuit or other damage might occur.

- Do not eat or smoke over your keyboard. Particles that fall into your keyboard can cause damage.

Lenovo programs

Your computer comes with Lenovo programs to help you work easily and securely.

Accessing Lenovo programs

To access Lenovo programs on your computer, do the following:

1. Open the Start menu and locate a program by the program name.
2. If the program is not displayed on the Start menu on Windows 7, click **All programs** to display all programs.
3. If you still do not find the program in the program list, search for the program in the search box.

Note: If you are using the Windows 7 operating system, some Lenovo programs are ready to be installed. You cannot find these programs through the above methods unless you have installed them first. To install these Lenovo programs, start the Lenovo PC Experience program, click **Lenovo Tools**, and then follow the instructions on the screen.

An introduction to Lenovo programs

This topic provides a brief introduction to Lenovo programs. Depending on your computer model, some of the programs might not be available.

The available programs are subject to change without notice. To learn more about the programs and other computing solutions offered by Lenovo, go to:

<https://support.lenovo.com>

Access Connections™ (Windows 7)	<p>This program is a connectivity assistant for creating and managing location profiles. Each location profile stores network settings required for connecting to a network infrastructure from a specific location such as home or office.</p> <p>This program enables you to switch between location profiles when you move your computer from place to place. Therefore, you can quickly and easily connect to a network without manually reconfiguring your settings and restarting the computer each time.</p>
Active Protection System™ (Windows 7)	<p>This program protects your internal storage drive when the shock sensor inside your computer detects a condition that could damage the drive. Such a condition includes system tilt, excessive vibration, or shock.</p> <p>The internal storage drive is less vulnerable to damage when it is not operating. This is because the drive stops spinning, and the read and write heads of the drive might also be moved to areas without data.</p> <p>When detecting that the environment is stable again (minimal change in system tilt, vibration, or shock), the shock sensor enables the internal storage drive.</p>
Communications Utility (Windows 7)	<p>This program enables you to configure settings for the integrated camera and audio devices.</p>

Fingerprint Manager Pro, Lenovo Fingerprint Manager, or Lenovo Touch Fingerprint Software	If your computer has a fingerprint reader, this program enables you to enroll your fingerprint and associate it with your passwords. As a result, fingerprint authentication can replace your passwords and enable simple and secure user access.
(Windows 7)	
Hotkey Features Integration	This software enables F1–F12 special keys and buttons on your computer. For example, when the microphone mute key or button is pressed, the microphone state switches between mute and unmute. The mute state indicator is displayed on the screen whenever the mute state is changed.
(Windows 7 and Windows 10)	
Lenovo Vantage	Your computer’s best features and capabilities should be easy to access and understand. With Lenovo Vantage, they are.
(Windows 10)	
	<p>Use Lenovo Vantage to do the following:</p> <ul style="list-style-type: none"> • Manage updates, get the latest drivers, and keep the software on your computer up-to-date. • Protect yourself from malicious Wi-Fi networks. • Optimize your computer performance, monitor your computer health. • Access your user guide, check warranty status, and view accessories customized for your computer. • Read how-to articles, explore Lenovo forums, and stay up-to-date on technology news with articles and blogs from trusted sources. • Configure hardware settings. • Create and manage your Lenovo ID.
	This app is filled with exclusive Lenovo content to help you learn more about what you can do with your Lenovo computer.
Lenovo PC Experience	This program helps you work easily and securely by providing easy access to various programs.
(Windows 7)	
	Note: This program cannot be found from the all program list or search box. To access this program, go to Control Panel. View Control Panel by Category, click Hardware and Sound → Devices and Printers , and then double-click the device with your computer name.
Lenovo Solution Center	This program enables you to troubleshoot and resolve computer problems. It combines diagnostic tests, system information collection, security status, and support information, along with hints and tips for optimal system performance.
(Windows 7)	
Mobile Broadband Connect	This program enables you to connect the computer to the mobile broadband network through a supported wireless-WAN card.
(Windows 7)	
Power Manager	This program provides convenient, flexible, and complete power management for the computer. It enables you to adjust your computer power settings to achieve the best balance between performance and power saving.
(Windows 7)	
Recovery Media	This program enables you to restore the contents of the internal storage drive to the factory default settings.
(Windows 7)	
System Update	This program enables you to keep the software on the computer up-to-date by downloading and installing software packages, including:
(Windows 7)	
	<ul style="list-style-type: none"> • Device drivers • Unified Extensible Firmware Interface (UEFI) basic input/output system (BIOS) updates • Other third-party programs

Chapter 2. Using your computer

This chapter provides information to help you use the various features provided by your computer.

Registering your computer

When you register your computer, information is entered into a database, which enables Lenovo to contact you if there is a recall or other severe problem. In addition, some locations offer extended privileges and services to registered users.

When you register your computer with Lenovo, you also will receive the following benefits:

- Quicker service when you call Lenovo for help
- Automatic notification of free software and special promotional offers

To register your computer with Lenovo, go to <https://support.lenovo.com/productregistration> and follow the instructions on the screen.

If you are using a Windows 7 operating system, you also can register your computer through the preinstalled Lenovo Product Registration program. The program starts automatically after you have used your computer for a period of time. Follow the instructions on the screen to register your computer.

Frequently asked questions

This topic provides a few tips that help you optimize the use of your ThinkPad notebook computers.

Can I get my user guide in another language?

To download the user guide in another language, go to <https://support.lenovo.com>. Then follow the instructions on the screen.

How do I get help about the Windows operating system?

The Windows help information system provides you with detailed information about using the Windows operating system so that you can get the most of your computer. To access the Windows help information system, click the **Start** button to open the Start menu, and then click **Get Help**. Additionally, you can use the Cortana® personal assistant to search for help, apps, files, settings, and so on.

How do I access Control Panel?

- **For Windows 7:** Click the **Start** button to open the Start menu and click **Control Panel**.
- **For Windows 10:** Click the **Start** button to open the Start menu, and then click **Windows System** → **Control Panel**.

How to turn off my computer?

- **For Windows 7:** Open the Start menu and click **Shut down**.
- **For Windows 10:** Open the Start menu, click  **Power**, and then click **Shut down**.

How to partition my storage drive?

To partition the storage drive of your computer in the Windows operating system, refer to <https://support.lenovo.com/solutions/ht503851>.

How do I use battery power more effectively when I am on the go?

- To conserve power, or to suspend operation without exiting programs or saving files, see “Power-saving modes” on page 28.
- To achieve the best balance between performance and power saving, create and apply power plans. See “Managing the battery power” on page 28
- If your computer will be turned off for an extended period of time, you can prevent battery power from draining by removing the battery.

How do I securely dispose of data stored on the internal storage drive?

- Study Chapter 5 “Security” on page 53 to find out how you can protect your computer from theft and unauthorized use.
- Before you dispose of the data on the storage drive, be sure to read the topic “Deleting data from your storage drive” on page 58.

How do I attach an external display?

- Refer to “Using an external display” on page 35.
- With the Extend desktop function, you can display output on both the computer display and an external display.

How do I attach or replace a device?

Refer to the appropriate topic in Chapter 10 “Replacing devices” on page 109.

I have been using the computer for some time already, and is getting slower. What should I do?

- Follow the “General tips for preventing problems” on page 87.
- Diagnose problems yourself by using the preinstalled diagnostic software. See “Diagnosing problems” on page 87.
- Check for recovery solutions in Chapter 9 “Recovery information” on page 105.

Print the following topics and keep them with your computer in case you are unable to access this electronic user guide when necessary.

- “Installing a new operating system” on page 61
- “Computer stops responding” on page 88
- “Power problems” on page 100





Using the multi-touch screen



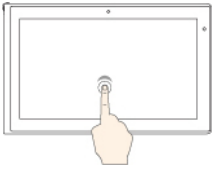

This topic provides instructions on how to use the multi-touch screen that is available on some models.

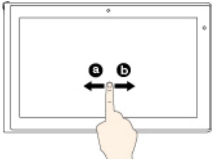
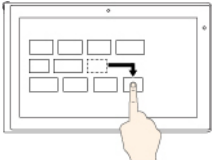
Notes:

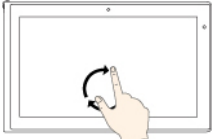
- Your computer screen might look different from the following illustrations.
- Depending on the program you use, some gestures might not be available.

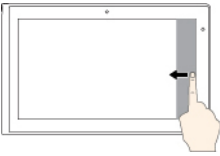
The following table introduces some frequently used gestures.

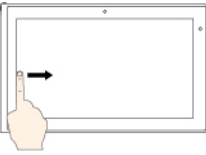
Touch gesture (touch models only)	Description
	<p>Touch: Tap.</p> <p>Mouse action: Click.</p> <p>Function: Open an app or perform an action on an open app, such as Copy, Save, and Delete, depending on the app.</p>
	<p>Touch: Tap and hold.</p> <p>Mouse action: Right-click.</p> <p>Function: Open a menu with multiple options.</p>
	<p>Touch: Slide.</p> <p>Mouse action: Scroll the mouse wheel, move the scroll bar, or click the scroll arrow.</p> <p>Function: Scroll through items, such as lists, pages, and photos.</p>
	<p>Touch: Drag an item to the location you want.</p> <p>Mouse action: Click, hold, and drag an item.</p> <p>Function: Move an object.</p>
	<p>Touch: Move two fingers closer together.</p> <p>Mouse action: Press the Ctrl key while scrolling the mouse wheel backward.</p> <p>Function: Zoom out.</p>
	<p>Touch: Move two fingers farther apart.</p> <p>Mouse action: Press the Ctrl key while scrolling the mouse wheel forward.</p> <p>Function: Zoom in.</p>
	<p>Touch: Put two or more fingers on an item and then rotate your fingers clockwise or counterclockwise.</p> <p>Mouse action: If the app supports rotation, click the rotation icon.</p> <p>Function: Rotate an item.</p> <p>Note: The gesture is supported only on the Windows 7 operating system.</p>

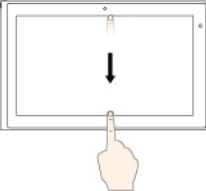
Touch gesture (touch models only)	Description
	<p>Touch: Swipe in from the right edge.</p> <p>Mouse action: Click the action center icon  in the Windows notification area.</p> <p>Function: Open the action center to see your notifications and quick actions.</p> <p>Note: The gesture is supported only on the Windows 10 operating system.</p>
	<p>Touch: Swipe in from the left edge.</p> <p>Mouse action: Click the task-view icon  on the taskbar.</p> <p>Function: View all your open windows in task view.</p> <p>Note: The gesture is supported only on the Windows 10 operating system.</p>
	<ul style="list-style-type: none"> <p>Short swipe for full-screened app or when your computer is in the tablet mode</p> <p>Touch: Swipe downwards shortly from the top edge.</p> <p>Mouse action: Move your pointer to the top edge of the screen.</p> <p>Function: Show a hidden title bar.</p> <p>Long swipe when your computer is in the tablet mode</p> <p>Touch: Swipe in from the top edge to the bottom edge.</p> <p>Mouse action: From the top edge of the screen, click and hold, move the pointer to the bottom of the screen, and then release.</p> <p>Function: Close the current app.</p> <p>Note: The gesture is supported only on the Windows 10 operating system.</p>

Tips on using the multi-touch screen

- The multi-touch screen is a glass panel covered with a plastic film. Do not apply pressure or place any metallic object on the screen, which might damage the touch panel or cause it to malfunction.
- Do not use fingernails, gloved fingers, or inanimate objects for input on the screen.
- Regularly calibrate the accuracy of the finger input to avoid a discrepancy.

Tips on cleaning the multi-touch screen

- Turn off the computer before cleaning the multi-touch screen.
- Use a dry, soft, and lint-free cloth or a piece of absorbent cotton to remove fingerprints or dust from the multi-touch screen. Do not apply solvents to the cloth.
- Gently wipe the screen using a top-down motion. Do not apply any pressure on the screen.

Using the special keys

Your computer has several special keys to help you work more easily and effectively.



1 Fn key

2 Function keys









You can configure the Fn key and function keys in the Keyboard Properties window by doing the following:

1. Go to Control Panel, and then change the view of Control Panel from Category to Large icons or Small icons.
2. Click **Keyboard**. In the Keyboard Properties window, click the **Fn and function keys** tab.
3. Select the options of your preference.



-  +  Enables or disables the Fn Lock function.





When the Fn Lock function is enabled: The Fn Lock indicator is on. To input F1–F12, press the function key directly. To initiate the special function printed as an icon on each key, press the Fn key and the corresponding function key.

When the Fn Lock function is disabled: The Fn Lock indicator is off. To initiate the special function printed as an icon on each key, press the function key directly. To input F1–F12, press the Fn key and the corresponding function key.

-  Mutes or unmutes the speakers. When the speakers are muted, the speaker-mute indicator turns on. If you mute the sound and turn off your computer, the sound will remain muted when you turn on your computer again. To turn on the sound, press  or .
-  Decreases the volume.
-  Increases the volume.
-  Mutes or unmutes the microphones. When the microphones are muted, the microphone-mute indicator turns on.
-  Darkens the computer display.
-  Brightens the computer display.

You can temporarily change the computer display brightness by pressing the two keys. To change the default brightness level, right-click the battery status icon in the Windows notification area. Then click **Adjust screen brightness** and make changes as desired.

-  Manages external displays.
-  Enables or disables the built-in wireless features.

- 
 - Windows 7: Opens **Control Panel**.
 - Windows 10: Opens the Settings window.
- 
 - Windows 7: Opens **Windows Search**.
 - Windows 10: Opens the Cortana search box.
-  Views all the programs that you have opened.
- 
 - Windows 7: Opens **Computer**.
 - Windows 10: Views all the programs.

Key combinations

- **Fn+Spacebar**: Controls the keyboard backlight. (available on some models)
There are three modes for the keyboard backlight: **Off**, **Low**, and **High**. Press Fn+Spacebar to switch the mode of the keyboard backlight.
- **Fn+B**: Has the same function as the Break key.
- **Fn+K**: Has the same function as the ScrLK key.
- **Fn+P**: Has the same function as the Pause key.
- **Fn+S**: Has the same function as the SysRq key.

Windows logo key

Press the Windows logo key to open the Start menu. For information about using the Windows logo key with other keys, refer to the help information system of the Windows operating system.

Using the ThinkPad pointing device

This section provides information about using the ThinkPad pointing device.

ThinkPad pointing device overview

The ThinkPad pointing device enables you to perform all the functions of a traditional mouse, such as pointing, clicking, and scrolling. With the ThinkPad pointing device, you also can perform various touch gestures, such as rotating and zooming in or out.

The ThinkPad pointing device consists of the following devices:

- 1** TrackPoint pointing device
- 2** Trackpad with buttons

Note: Depending on the model, your TrackPoint pointing device and the trackpad might look different from the illustration in this topic.

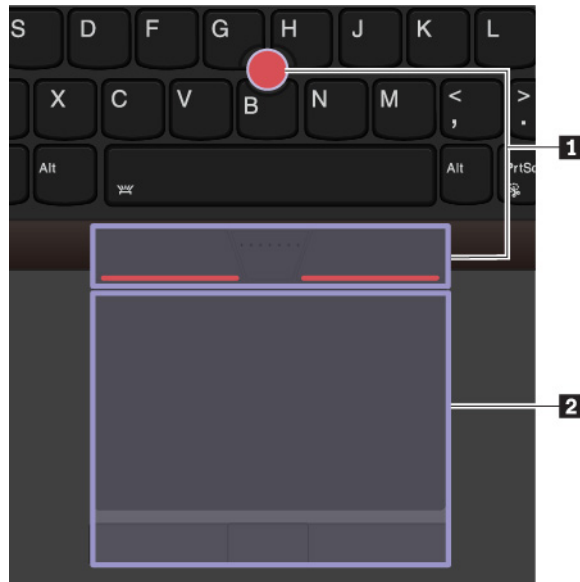

By default, both the TrackPoint pointing device and the trackpad with buttons are active with the touch gestures enabled. To change the settings, see “Customizing the ThinkPad pointing device” on page 25.

Using the TrackPoint pointing device

The TrackPoint pointing device enables you to perform all the functions of a traditional mouse, such as pointing, clicking, and scrolling.

The TrackPoint pointing device consists of the following components:

- 1** Pointing stick
- 2** Left-click button (primary-click button)
- 3** Right-click button (secondary-click button)
- 4** Middle button

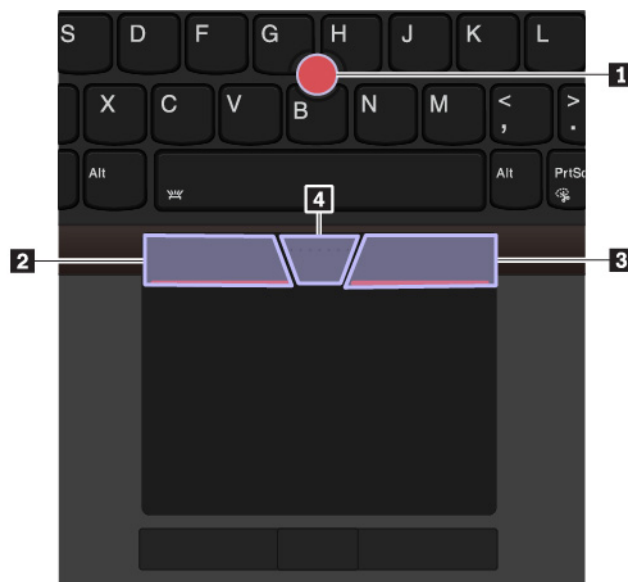

To use the TrackPoint pointing device, see the following instructions:

Note: Place your hands in the typing position and use your index finger or middle finger to apply pressure to the pointing-stick nonslip cap. Use either thumb to press the left-click button or right-click button.

- **Point**

Use the pointing stick **1** to move the pointer on the screen. To use the pointing stick, apply pressure to the pointing-stick nonslip cap in any direction parallel to the keyboard. The pointer moves accordingly but the pointing stick itself does not move. The speed at which the pointer moves depends on the amount of pressure you apply to the pointing stick.

- **Left-click**

Press the left-click button **2** to select or open an item.

- **Right-click**

Press the right-click button **3** to display a shortcut menu.

- **Scroll**

Press and hold the dotted middle button **4** while applying pressure to the pointing stick in the vertical or horizontal direction. Then you can scroll through the document, Web site, or apps.

Using the trackpad with buttons

The trackpad with buttons consists of the following components:

1 Trackpad

2 Right-click button (secondary-click button)

3 Middle-click button

4 Left-click button (primary-click button)

To move the pointer on the screen, slide your fingertip over the trackpad **1** in the corresponding direction. The functions of the right-click button **2**, middle-click button **3**, and left-click button **4** correspond to those of the right, middle, and left mouse buttons on a conventional mouse.

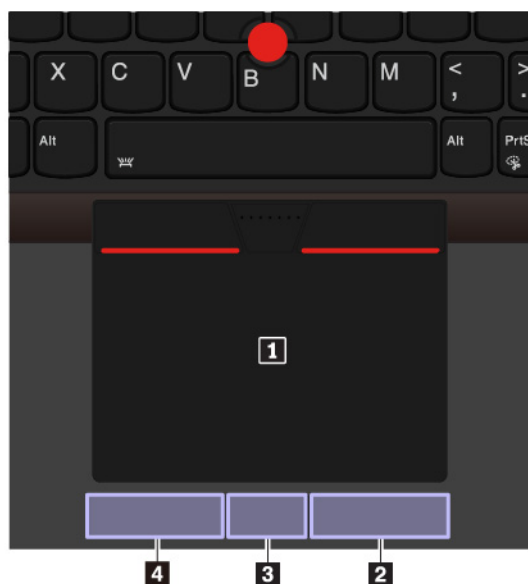

If the trackpad surface is stained with oil, turn off the computer first. Then gently wipe the trackpad surface with a soft and lint-free cloth moistened with lukewarm water or computer cleaner.

Using the trackpad touch gestures

The entire trackpad surface is sensitive to finger touch and movement. You can use the trackpad to perform the same point and click actions as you would use a traditional mouse. You also can use the trackpad to perform various touch gestures.

The following section introduces some frequently used touch gestures such as tapping, dragging, and scrolling. For more gestures, see the help information system of the ThinkPad pointing device.

Notes:

- When using two or more fingers, ensure that you position your fingers slightly apart.
- Some gestures are not available if the last action was done from the TrackPoint pointing device.
- Some gestures are only available when you are using certain apps.
- Depending on the model, the trackpad on your computer might look different from the illustrations in this topic.

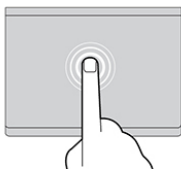

Tap

Tap anywhere on the trackpad with one finger to select or open an item.

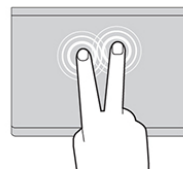

Two-finger tap

Tap anywhere on the trackpad with two fingers to display a shortcut menu.

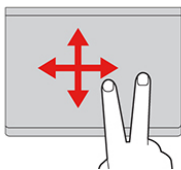

Two-finger scroll

Put two fingers on the trackpad and move them in the vertical or horizontal direction. This action enables you to scroll through the document, Web site, or apps.

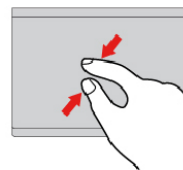

Two-finger zoom out

Put two fingers on the trackpad and move them closer together to zoom out.

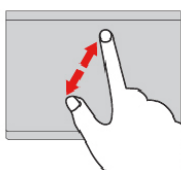

Two-finger zoom in

Put two fingers on the trackpad and move them farther apart to zoom in.

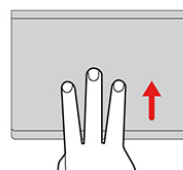

Swipe three fingers up

Put three fingers on the trackpad and move them up to open the task view to see all your open windows.

Note: The gesture is supported only on the Windows 10 operating system.

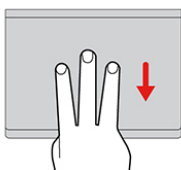

Swipe three fingers down

Put three fingers on the trackpad and move them down to show the desktop.

Note: The gesture is supported only on the Windows 10 operating system.

Customizing the ThinkPad pointing device

You can customize the ThinkPad pointing device so you can use it more comfortably and efficiently. For example, you can choose to enable the TrackPoint pointing device, the trackpad, or both. You also can disable or enable the touch gestures.

To customize the TrackPoint pointing device, do the following:

1. Open the Start menu, and then click **Settings → Devices → Mouse**.
2. Follow the on-screen instructions to customize TrackPoint.

To customize the trackpad, do the following:

1. Open the Start menu, and then click **Settings → Devices → Touchpad**.
2. Follow the on-screen instructions to customize the trackpad.

Replacing the cap on the pointing stick

The cap  on the end of the pointing stick is removable. After you use the cap for a period of time, you might consider replacing the cap with a new one.

Notes:

- Ensure that you use a cap with grooves  as shown in the following illustration.
- Depending on the model, your keyboard might look different from the illustration in this topic.

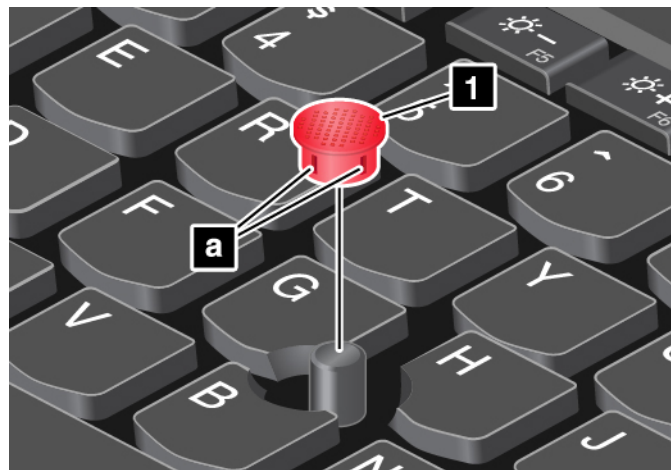

Power management

This section provides information about how to use ac power and battery power to achieve the best balance between performance and power management.

Using the ac power adapter

The power to run your computer can come either from the battery or from ac power. While you use ac power, the battery charges automatically.

Your computer comes with an ac power adapter and a power cord.

- ac power adapter: Converts ac power for notebook computer use.
- Power cord: Connects the ac outlet and the ac power adapter.

Connecting the ac power adapter

To connect the computer to ac power, ensure that you follow the steps in order:

Attention: Using an improper power cord might severely damage your computer.

1. Connect the power cord to the ac power adapter.

2. Connect the ac power adapter to the power connector of the computer.
3. Connect the power cord to an electrical outlet.

Tips on using the ac power adapter

- When the ac power adapter is not in use, disconnect it from the electrical outlet.
- Do not bind the power cord tightly around the ac power adapter transformer pack when it is connected to the transformer.

Using the battery

When you use your computer away from electrical outlets, you depend on battery power to keep your computer running. Different computer components consume power at different rates. The more you use the power-intensive components, the faster you consume battery power.

Spend more time unplugged with ThinkPad batteries. Mobility has revolutionized business by enabling you to take your work wherever you go. With ThinkPad batteries, you are able to work longer without being tied to an electrical outlet.

Checking the battery status

Move your pointer to the battery-status icon in the Windows notification area to check the battery status. The battery-status icon displays the percentage of battery power remaining and how long you can use your computer before you must charge the battery.

The rate at which you use battery power determines how long you can use the battery of your computer between charges. Because every computer user has individual habits and needs, it is difficult to predict how long a battery charge lasts. There are two main factors:

- How much energy is stored in the battery when you begin to work
- The way you use your computer, for example:
 - How often you access the storage drive
 - How bright you make the computer display
 - How often you use the wireless feature

Enabling the battery alarm on the Windows 7 operating system

For the Windows 7 operating system, you can configure your computer so that when the battery power falls below a certain level, three events occur: the alarm goes off, a message is displayed, and the computer display is turned off.

To enable the battery alarm, do the following:

1. Start the Power Manager program. See “Accessing Lenovo programs” on page 14.
2. Click the **Global Power Settings** tab.
3. For **Low battery alarm** or **Critically low battery alarm**, set the percentage of the power level and set the action.

Note: If your computer enters sleep or hibernation mode when the battery power is low without the alarm message, the message is displayed when the computer resumes. To resume normal operation, click **OK** when the message is displayed.

Charging the battery

When you find that the remaining battery power is low, charge your battery or replace the battery with a charged battery.

If an ac outlet is convenient, connect the computer to ac power. The battery is fully charged in about four to eight hours. The actual charging time depends on the battery size, the physical environment, and whether you are using the computer. You can check the battery charging status at any time through the battery-status icon in the Windows notification area.

Note: To maximize the life of the battery, the computer does not start recharging the battery if the remaining power is greater than 95%.

When to charge the battery

- Battery charging is affected by its temperature. The recommended temperature range for charging the battery is between 10°C (50°F) and 35°C (95°F).

Note: To check the battery temperature, do the following:

1. Open Lenovo Vantage. See “Accessing Lenovo programs” on page 14.
 2. Click **Hardware Settings** → **Power**.
 3. Locate the **Power Status** section and then click **Show Details** to view the battery temperature.
- Charge the battery in any of the following conditions:
 - A new battery is installed.
 - The percentage of power remaining is low.
 - The battery has not been used for a long time.

Maximizing the battery life

To maximize the life of the battery, do the following:

- Use the battery until the charge is depleted.
- Recharge the battery completely before using it. You can see whether the battery is fully charged from the battery-status icon in the Windows notification area.
- Always use power management features such as power-saving modes.

Managing the battery power

To achieve the best balance between performance and power saving, adjust your power plan settings. To adjust power plan settings, do the following:

1. Go to Control Panel, and then change the view of Control Panel from Category to Large icons or Small icons.
2. Click **Power Options**.
3. Follow the instructions on the screen.

For more information, see the Windows help information system.

Power-saving modes

There are several modes that you can use at any time to conserve power. This section introduces each mode and gives tips on the effective use of battery power.

- **Screen blank mode (for Windows 7 only)**

The computer display requires considerable battery power. To enter screen blank mode, right-click the battery-status icon in the Windows notification area and select **Power off display**.

- **Sleep mode**

In sleep mode, your work is saved to memory, and then the storage drive and the computer display are turned off. When your computer wakes up, your work is restored within seconds.

To put your computer to sleep mode, do the following:

- **For Windows 7:** Open the Start menu and click the arrow next to the **Shut down** button. Click **Sleep** from the menu displayed.
- **For Windows 10:** Open the Start menu, click  **Power**, and then click **Sleep**.

- **Hibernation mode**

By using this mode, you can turn off your computer completely without saving files or exiting any programs that are running. When the computer enters hibernation mode, all open programs, folders, and files are saved to the storage drive, and then the computer turns off.

To put the computer to hibernation mode, do the following:

- **For Windows 7:** Open the Start menu and click the arrow next to the **Shut down** button. Click **Hibernate** from the menu displayed.
- **For Windows 10:** Define what the power button does first, and then press the power button to put the computer to hibernation mode.

If you put your computer to hibernation mode with the wake-up function disabled, the computer does not consume any power. The wake-up function is disabled by default. If you put your computer to hibernation mode with the wake-up function enabled, the computer consumes a small amount of power.

To enable the wake-up function, do the following:

1. Open Control Panel, view Control Panel by Category, and then click **System and Security**.
2. Click **Administrative Tools**.
3. Double-click **Task Scheduler**. If you are prompted for an administrator password or confirmation, type the password or provide confirmation.
4. From the left pane, select the task folder for which you want to enable the wake-up function. The scheduled tasks are displayed.
5. Click a scheduled task, and then click the **Conditions** tab.
6. Under **Power**, select **Wake the computer to run this task**.

- **Wireless off**

When you are not using the wireless features, such as Bluetooth or wireless LAN, turn them off to help conserve power.

Ethernet connections

You can connect your computer to a local network or a broadband connection by using the built-in Ethernet feature of the computer.



Your computer has an Ethernet connector. To avoid the risk of electrical shock, do not connect the telephone cable to the Ethernet connector.

Wireless connections

Wireless connection is the transfer of data without the use of cables but by means of radio waves only.

Using the wireless-LAN connection

A wireless local area network (LAN) covers a relatively small geographic area, such as an office building or a house. Devices based on the 802.11 standards can connect to this type of network.

Your computer comes with a built-in wireless network card to help you establish wireless connections and monitor the connection status.

To establish a wireless-LAN connection, do the following:

1. Turn on the wireless feature. See “Using the special keys” on page 20.
2. Click the wireless-network-connection-status icon in the Windows notification area. A list of available wireless networks is displayed.
3. Select a network to connect to it. Provide required information if needed.

The computer automatically connects to an available and remembered wireless network when the location changes. If the available wireless network is secured, provide the password as required. For more information, see the Windows help information system.

Tips on using the wireless-LAN feature

To achieve the best connection, use the following guidelines:

- Place your computer so that there are as few obstacles as possible between the wireless-LAN access point and the computer.
- Open your computer cover to an angle of slightly more than 90 degrees.

Checking the wireless-LAN connection status

You can check the wireless-LAN connection status through the wireless-network-connection-status icon in the Windows notification area. The more bars encompassed, the better the signal is.

For the Windows 7 operating system, you also can check the wireless-LAN connection status through the Access Connections gauge in the Windows notification area. The more bars encompassed, the better the signal is.

Using the wireless-WAN connection

Wireless wide area network (WAN), which uses cellular networks for data transmission, enables you to establish wireless connections over remote public or private networks. These connections can be maintained over a large geographical area by use of multiple antenna sites or satellite systems maintained by wireless service providers.

Some ThinkPad notebook computers come with a wireless-WAN card installed, which provides some wireless-WAN technologies, such as HSPA, 3G, 4G, or LTE. By using the wireless-WAN card, you can establish wireless-WAN connections.

Note: The wireless-WAN service is provided by authorized service providers in some countries or regions.

Tips for using the wireless-WAN feature

To achieve the best connection, use the following guidelines:

- Keep your computer away from your body.
- Place your computer on a flat surface and open your computer display to an angle of slightly more than 90 degrees.
- Place your computer away from concrete or brick walls that might dampen cellular signals.

- Best reception is available near windows and other locations where cellular phone reception is the strongest.

Checking the wireless-WAN connection status

You can check the wireless-WAN connection status through the wireless-network-connection-status icon in the Windows notification area. The more bars encompassed, the better the signal is.

For the Windows 7 operating system, you also can check the wireless-WAN connection status through the Access Connections gauge in the Windows notification area. The more bars encompassed, the better the signal is.

Using the Bluetooth connection

Bluetooth can connect devices that are within a short distance from one another, and is commonly used for connecting peripheral devices to a computer, transferring data between hand-held devices and a personal computer, or remotely controlling and communicating with devices such as mobile phones.

Depending on the model, your computer might support the Bluetooth feature. To transfer data through the Bluetooth feature, do the following:

Note: If you use the wireless feature (the 802.11 standards) of your computer simultaneously with a Bluetooth option, the data transmission speed can be delayed and the performance of the wireless feature can be degraded.

1. Ensure that the Bluetooth feature is enabled.
 - **For Windows 7:** Press the wireless-radios control key  and turn on the Bluetooth feature.
 - **For Windows 10:** Open the Start menu, and then click **Settings → Devices → Bluetooth & other devices**. Turn on the **Bluetooth** switch to enable the Bluetooth feature.
2. Right-click the data that you want to send.
3. Select **Send To → Bluetooth Devices**.
4. Select a Bluetooth device, and then follow the instructions on the screen.

For more information, refer to the Windows help information system and the Bluetooth help information system.

Using audio features

Your computer is equipped with the following items:

- Audio connector, 3.5 mm (0.14 inches) in diameter
- Microphones
- Speakers

Your computer also has an audio chip that enables you to enjoy various multimedia audio features, such as the following:

- Compliant with High Definition Audio
- Playback of MIDI and MP3 files
- Recording and playback of PCM and WAV files
- Recording from various sound sources, such as a headset attached

The following list provides information about supported functions of the audio devices attached to the connectors on your computer or the docking station.

- **Headset with a 3.5-mm (0.14-inch), 4-pole plug:** Headphone and microphone functions
- **Conventional headphone:** Headphone function

Note: The conventional microphone is not supported.

Using the smart audio feature

The smart audio feature is supported on some computer models. To help protect against hearing loss, the feature limits the computer's maximum wide band true RMS output voltage to 130 mV when a headset or headphone is connected.

To change the setting, do the following:

1. Go to Control Panel and view by Large icons.
2. Click **SmartAudio**. In the window displayed, click the **Disable Headphone Limiter** icon. Then follow the on-screen instructions.

Using the camera

If your computer has a camera, you can use the camera to preview your video image and take a snapshot of your current image.

To start the camera, do the following:

- **For Windows 7:** Start the Communications Utility program. See "Accessing Lenovo programs" on page 14.
- **For Windows 10:** Open the Start menu and click **Camera**.

When the camera is started, the indicator is turned on in green, indicating that the camera is in use.

You also can use the integrated camera with other programs that provide features such as photographing, video capturing, and video conferencing. To use the integrated camera with other programs, open one of the programs and start the photographing, video capturing, or video conferencing function. Then, the camera starts automatically and the green camera status indicator turns on. For more information about using the camera with a program, see the help information system of the program.

Configuring camera settings

You can configure the camera settings to meet your needs, such as adjusting the quality of the video output.

To configure the camera settings, do the following:

- **For Windows 7:** Start the Communications Utility program and configure the camera settings as desired.
- **For Windows 10:** Do one of the following:
 - Open the Camera app, and click the settings icon in the upper-right corner. Follow the instructions on the screen to configure the camera settings as desired.
 - Open the Start menu and then click **Lenovo Vantage** → **Hardware Settings** → **Audio/Visual**. Locate the **Camera** section and then follow the instructions on the screen to configure the camera settings.

Using the color sensor

The color sensor enables you to measure and adjust the color accuracy of your computer display. Therefore, a color image or graphic is rendered as close as possible to its original intent. The color profile for ThinkPad computer displays is preinstalled on your computer. If you want to install a different color profile, go to:

<https://support.lenovo.com>

To use the color sensor, do the following:

- **For Windows 7:** Open the Start menu, click **All Programs → X-Rite → PANTONE Color Calibrator**, and then follow the instructions on the screen.
- **For Windows 10:** Open the Start menu, click **X-Rite → PANTONE Color Calibrator**, and then follow the instructions on the screen.

When the color sensor is in use, the color-sensor indicator on the computer outer lid blinks twice at regular intervals. When the color measuring and adjustment finishes, the color-sensor indicator stays on.

After you use the color sensor for the first time, a calibration profile `ECCM2SensorData.dat` is generated. Back up this calibration profile on an external storage device in case that both the color sensor and the internal storage device are replaced.

To locate the DAT file, do the following:

- **For Windows 7:** Go to `C:\ProgramData\X-Rite\ECCM-2`.
- **For Windows 10:** Go to **This PC → Documents → X-Rite**.

The display provides a color profile that can work with the Microsoft Image Color Management (ICM) function. If the graphics software you are using is compatible with ICM, you can display a color image on your monitor and match it with the same quality one on another device, such as a scanner or a printer.

For more information about the Microsoft ICM, see the Windows help information system.

Using an ExpressCard, a media card, or a smart card

Your computer has an ExpressCard slot and a media-card slot. Depending on the model, your computer might also have a smart-card slot.

Supportable media card types

The media-card reader on your computer only supports the following media cards:

- MultiMediaCard (MMC)
- Secure Digital (SD) card

Note: Your computer does not support the CPRM feature for the SD card.

- Secure Digital eXtended-Capacity (SDXC) card
- Secure Digital High-Capacity (SDHC) card

Supportable smart card type

Smart cards can be used for authentication, data storage, and application processing. Smart cards also might provide strong security authentication for single sign-on (SSO) within large organizations. The smart card reader on your computer only supports the smart card of the following specifications:



- Length: 85.60 mm (3.37 inches)
- Width: 53.98 mm (2.13 inches)
- Thickness: 0.76 mm (0.03 inch)

Do not insert smart cards with slits into your computer. Otherwise, the smart card reader might get damaged.

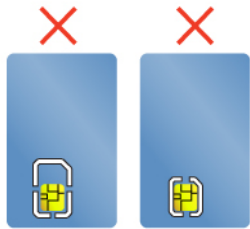

Installing an ExpressCard, a media card, or a smart card

To install the card, do the following:

Attention: Before you start installing a card, touch a metal table or a grounded metal object. This action reduces any static electricity from your body. The static electricity could damage the card.

1. Locate the appropriate type of slot for your card. See “Computer controls, connectors, and indicators” on page 1.
2. Ensure that the card is correctly oriented:
 - For the ExpressCard: The notched edge of the card is facing upward and pointing toward the card slot.
 - For the media card: The metal contacts are facing down and pointing toward the card slot.
 - For the smart card: The metal contacts are facing upward and pointing toward the card slot.
3. Press the card firmly into the card slot.

If the plug-and-play feature is not enabled for the installed ExpressCard, media card or smart card, do the following to enable the feature:

1. Go to Control Panel.
2. Click **Hardware and Sound**.
3. Click **Device Manager**. If you are prompted for an administrator password or confirmation, type the password or provide confirmation.
4. From the **Action** menu, select **Add legacy hardware**. The Add Hardware Wizard starts.
5. Follow the instructions on the screen.

Removing an ExpressCard, a media card, or a smart card

Attention:

- Before removing a card, stop the card first. Otherwise, data on the card might be corrupted or lost.

- While transferring data to or from an ExpressCard, a media card, or a smart card, do not put your computer into sleep or hibernation mode before the data transfer is completed; otherwise, your data could become damaged.
- Do not remove a card while the computer is in sleep mode or hibernation mode. Otherwise, the system might not respond when you try to resume operation.

To remove a card, do the following:

1. Click the triangular icon in the Windows notification area to show hidden icons. Then, right-click the **Safely Remove Hardware and Eject Media** icon.
2. Select the item you want to remove to stop the card.
3. Press the card to eject it from your computer.
4. Remove the card and store it safely for future use.

Note: After you eject the card from the operating system, the card can no longer be accessed. To access the card, you must remove it first, and then insert it again.

Using an external display

You can use an external display such as a projector or a monitor to give presentations or to expand your workspace. This topic introduces how to connect an external display, choose display modes, and change display settings.

Your computer supports the following video resolution, if the external monitor also supports that resolution.

- Up to 3840 x 2160 @ 60 Hz, with an external display connected to the Thunderbolt 3 connector or the Mini DisplayPort connector.
- Up to 3840 x 2160 @ 30 Hz, with an external display connected to the HDMI connector

For more information about the external display, refer to the manuals provided with it.

Connecting an external display

You can use either a wired display or a wireless display. The wired display can be connected to a video connector such as the HDMI connector and Mini DisplayPort connector by a cable. The wireless display can be added through the Wi-Di or Miracast function.

- **Connecting a wired display**

Note: When you connect an external monitor, a video interface cable with a ferrite core is required.

1. Connect the external display to an appropriate video connector on your computer, such as the HDMI connector or Mini DisplayPort connector.
2. Connect the external display to an electrical outlet.
3. Turn on the external display.

If your computer cannot detect the external display, right-click on the desktop, and then click **Screen resolution/Display settings → Detect**.

- **Connecting a wireless display**

Note: To use a wireless display, ensure that both your computer and the external display support the Wi-Di or Miracast feature.

- **For Windows 7**

Start the Intel® Wi-Di program. Select the desired wireless display in the list and follow the instructions on the screen.

– For Windows 10

Do one of the following:

- Open the Start menu, and then click **Settings → Devices → Connected devices → Add a device**.
- Click the action center icon  in the Windows notification area. Click **Connect**. Select the desired wireless display and follow the instructions on the screen.

For more information, refer to the Windows help information system.

Choosing a display mode

You can display your desktop and apps on the computer display, the external display, or both. To choose how to display the video output, press the display-mode switching key  and then select a display mode you prefer.

There are four display modes:

- **PC screen only:** Displays the video output only on your computer screen.
Note: Depending on the situation, you might see **Disconnect**, **PC screen only**, **Computer only**, or **Disconnect projector**.
- **Duplicate:** Displays the same video output on both your computer screen and an external display.
- **Extend:** Extends the video output from your computer display to an external display. You can drag and move items between the two displays.
- **Second screen only:** Shows the video output only on an external display.

Note: Depending on the situation, you might see **Projector only** or **Second screen only**.

Note: If you show programs using DirectDraw or Direct3D® in full-screen mode, only the main display shows the video output.

Changing display settings

You can change the settings for both the computer display and the external display. For example, you can define which one is the main display and which one is the secondary display. You also can change the resolution and orientation.

To change display settings, do the following:

1. Right-click on the desktop and select **Screen Resolution** or **Display settings**.
2. Select the display that you want to configure.
3. Change display settings as you want.

Note: If you set a higher resolution for the computer display than the external display, only part of the screen can be shown on the external display.

Traveling with your computer

This topic provides information to help you work with your computer when you are traveling.

Use the following travel tips to travel more confidently and efficiently with your computer.

- When your computer goes through the x-ray machines at airport security stations, it is important to keep your eyes on the computer at all times to prevent theft.
- Consider bringing an electrical adapter for use on an airplane or automobile.

- If you carry an ac power adapter, detach the ac cord from it to avoid damaging the cord.

Travel tips on airplanes

If you carry your computer onto an airplane, observe the following tips:

- Be careful about the seat in front of you on airplanes. Angle your computer display so that it does not get caught when the person in front of you leans back.
- When taking off, remember to turn off your computer or put it to hibernation mode.
- If you intend to use your computer or wireless services (such as Internet and Bluetooth), check with the airline for restrictions and availability of services before boarding the airplane. If there are restrictions on the use of computers with wireless features on the airplane, you must abide by those restrictions.

The Airplane mode is supported on the Windows 10 operating system. In the Airplane mode, all wireless features are disabled.

To enable the Airplane mode, do the following:

1. Open the Start menu, and then click **Settings → Network & Internet → Airplane mode**.
2. Slide the **Airplane mode** control to turn it on.

Travel accessories

If you are traveling to another country or region, you might want to consider an appropriate ac power adapter for the country or region to which you are traveling.

To purchase travel accessories, go to:

<https://www.lenovo.com/accessories>

Chapter 3. Enhancing your computer

This chapter provides instructions on how to use hardware devices to expand your computer capabilities.

Finding ThinkPad options

If you want to expand the capabilities of your computer, Lenovo has a number of hardware accessories and upgrades to meet your needs. Options include memory modules, storage devices, network cards, port replicators or docking stations, batteries, power adapters, keyboards, mice, and more.

To shop at Lenovo, go to:

<https://www.lenovo.com/accessories>

ThinkPad Pen Pro

Depending on the model, your computer might come with the ThinkPad Pen Pro (referred to as the pen in this section). The pen enables you to write and draw in a nature manner.

This section introduces the basic use of the pen. For more information, refer to the documentation of the pen.

Use the pen instead of your finger in conditions such as the following:

- You need precise and detailed input, such as drawing a picture or using the handwriting mode.
- Too many elements are crowded on the screen, for example, when you are playing games.
- You want to keep your screen free from smudges.
- You have long fingernails and it is difficult for you to type.

Notes:

- The pen is not waterproof. Take care not to drop the pen in water.
- The pen contains pressure sensors. Do not push the tip of the pen for an extended period of time. Do not make the pen subject to shock or vibration.

Pen overview

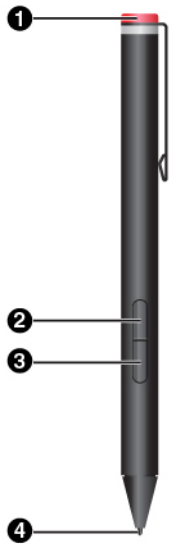

❶ End cap

Unscrew the end cap to install or replace a battery.

❷ Right-click button

To right-click, tap the tip on the screen and press the right-click button, or hold the pen tip on the screen for one second.

❸ Eraser button

To erase text or drawing, press and hold the eraser button and drag the tip across the area you want to erase.

❹ Pen tip

To click, tap on the screen with the tip. To double-click, tap twice.

Installing a battery to power the pen

Depending on the model, your pen might not be installed with a battery. To install an AAAA alkaline battery, do the following:

1. Unscrew the end cap.
2. Insert an AAAA alkaline battery into the battery compartment.
3. Reinstall the end cap.
4. Tighten the end cap.

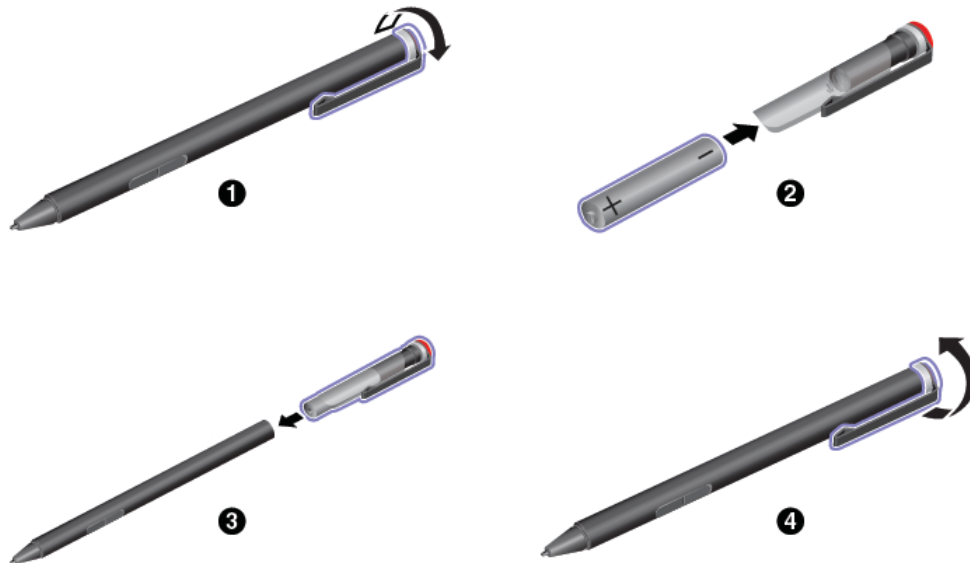

ThinkPad Workstation Dock

Depending on the model, your computer might come with the ThinkPad Workstation Dock (referred to as docking station in this section). Attach your computer to the docking station to expand working capability.

ThinkPad Workstation Dock overview

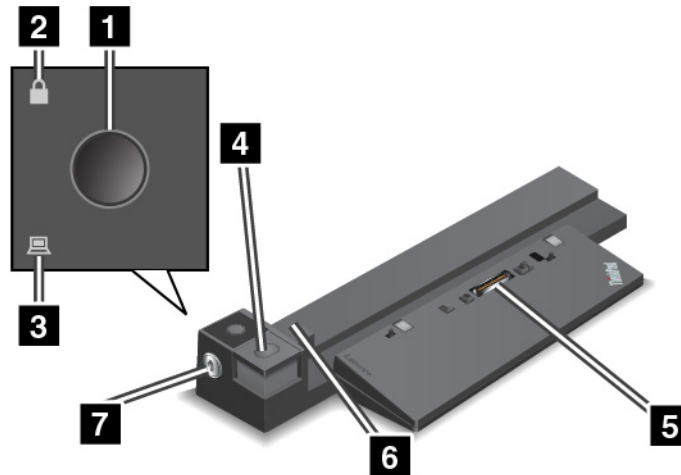

1 Power button: Press the power button to turn on or turn off the computer.

2 Key lock indicator: This indicator turns on when the system lock is in the locked position.

3 Docking status indicator: This indicator turns on when your computer is attached to the docking station properly.

4 Eject button: Press the eject button to eject the computer from the docking station.

5 Docking-station connector: Connect the docking station to the computer.

6 Adjuster: Use the adjuster as a guide to align your computer with the docking station.

7 System lock: Use the system lock to lock or unlock the eject button.

- When the system lock is in the locked position, the eject button is locked, and you cannot attach or detach your computer.
- When the system lock is in the unlocked position, the eject button is unlocked, and you can attach or detach your computer.

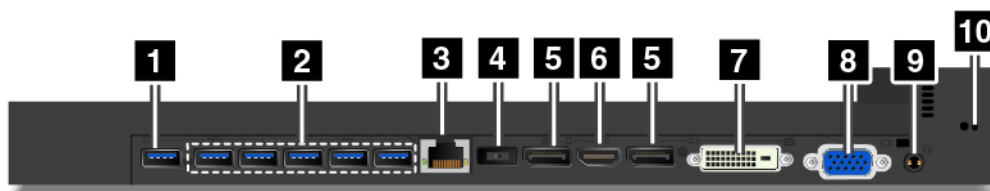

1 Always On USB connector: Connect USB-compatible devices or charge some mobile digital devices and smartphones.

2 USB 3.0 connectors: Connect USB-compatible devices, such as a USB keyboard, a USB mouse, a USB storage device, or a USB printer.

3 Ethernet connector: Connect to an Ethernet LAN.

Note: When your computer is attached to the docking station, always use the Ethernet connector or the external monitor connectors on the docking station. Do not use the ones on the computer.

4 Power connector: Connect the computer to ac power.

5 DisplayPort connectors

6 HDMI connector

7 DVI connector

8 VGA connector

Use the DisplayPort connectors, HDMI connector, DVI connector, or VGA connector to connect the computer to the compatible projector, external monitor, or television.

To connect a DVI display, do the following:

1. Ensure that the computer is connected to the docking station and works properly.
2. Turn off the computer.
3. Connect the DVI display to the DVI connector on the docking station, and then connect the display to an electrical outlet.
4. Turn on the DVI display.
5. Turn on the computer.

Note: Turn on the DVI display *before* you turn on the computer. Otherwise the system cannot recognize the display.

9 Audio connector: Connect headphones or a headset with a 3.5-mm (0.14-inch), 4-pole plug.

10 Security-lock slot: To protect your docking station from theft, lock your docking station to a desk, table, or other non-permanent fixture. Use a security cable lock that fits this security-lock slot.

Attaching the docking station to your computer

Attention: When the computer is attached to a docking station, do not pick up the assembly by taking hold of the computer only. Always hold the whole assembly. Otherwise the docking station might drop down.

To attach the docking station to your computer, do the following:

1. Disconnect all cables and devices from the computer. Ensure that the system lock key is in the unlocked position as shown (horizontal).

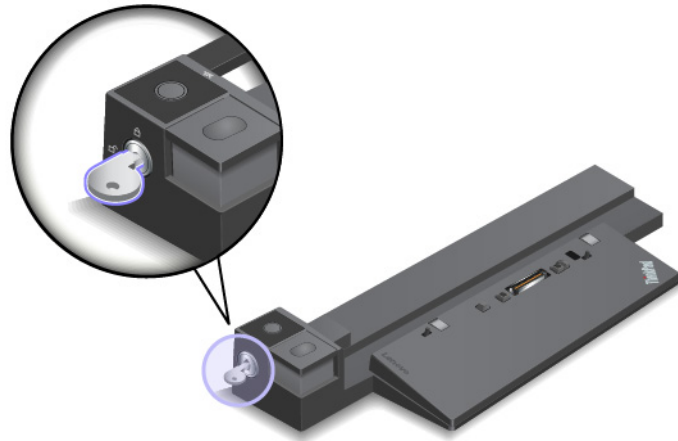

2. Attach your computer to the docking station as shown until you hear a click **1**. Turn the system lock key to the locked position (vertical) **2**.

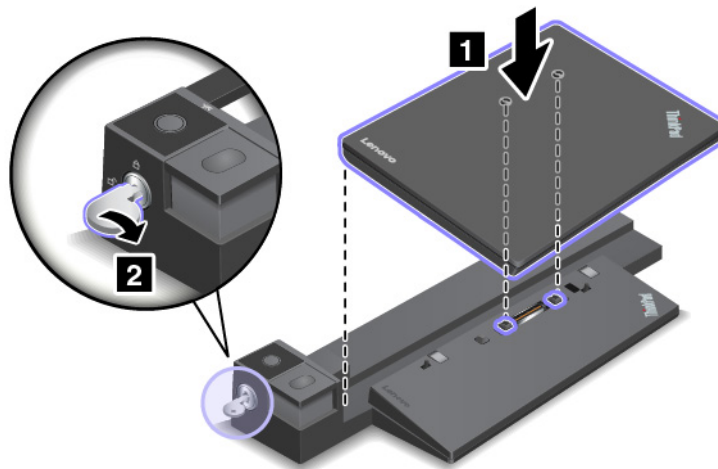

3. Check the docking status indicator. If the indicator is off, your computer is not attached to the docking station successfully. To solve the problem, detach and reattach the computer. If the problem persists, detach and reattach the ac power adapter of the docking station.

Note: If you attach the computer to the docking station, but do not connect the docking station to ac power, your computer consumes battery power.

Detaching the docking station from your computer

Attention: When the computer is attached to a docking station, do not pick up the assembly by taking hold of the computer only. Always hold the whole assembly. Otherwise the docking station might drop down.

To detach the docking station from your computer, do the following:

1. Disconnect all cables and devices from the computer and the docking station.
2. Turn the system lock key to the unlocked position (horizontal).

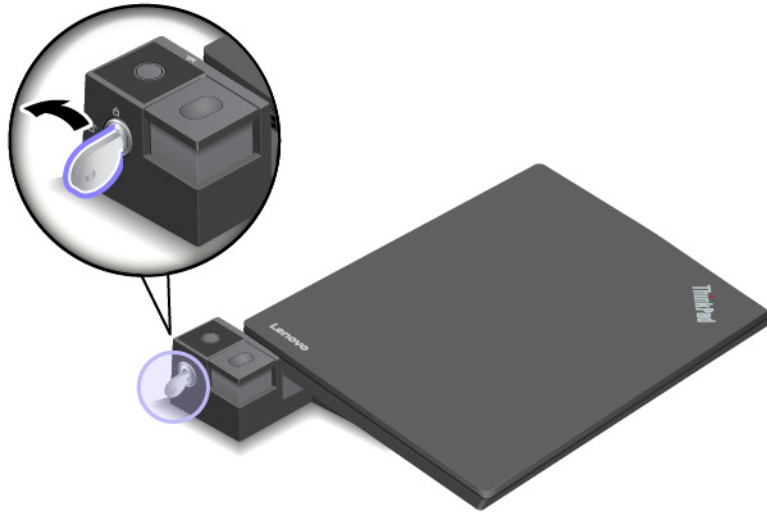

3. Press the eject button to eject the computer **1**, and then grasp both sides of the computer to remove it **2**.

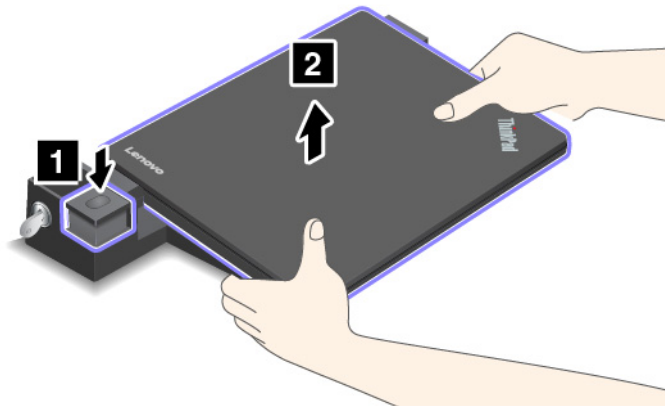

Guideline on connecting multiple external displays to the docking station

Do not use the connectors as shown in the following illustrations at the same time for connecting multiple displays. Otherwise, one of the displays will not work.

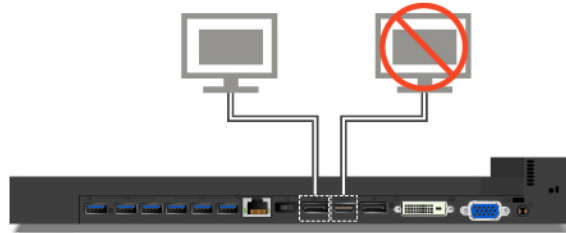

Chapter 4. Accessibility, ergonomic, and maintenance information

This chapter provides information about accessibility, ergonomic, and cleaning and maintenance.

Accessibility information

Lenovo is committed to providing users who have hearing, vision, and mobility limitations with greater access to information and technology. This section provides information about the ways these users can get the most out of their computer experience. You also can get the most up-to-date accessibility information from the following Web site:

<https://www.lenovo.com/accessibility>

Keyboard shortcuts

The following list contains keyboard shortcuts that can help make your computer easier to use.

Note: Depending on your keyboard, some of the following keyboard shortcuts might not be available.

- **Windows logo key + U:** Open Ease of Access Center
- **Right Shift for eight seconds:** Turn on or turn off Filter Keys
- **Shift five times:** Turn on or turn off Sticky Keys
- **Num Lock for five seconds:** Turn on or turn off Toggle Keys
- **Left Alt+Left Shift+Num Lock:** Turn on or turn off Mouse Keys
- **Left Alt+Left Shift+PrtScn (or PrtSc):** Turn on or turn off High Contrast

For more information, go to <https://windows.microsoft.com/>, and then search using any of the following keywords: keyboard shortcuts, key combinations, shortcut keys.

Ease of Access Center

Ease of Access Center on the Windows operating system enables you to configure your computers to suit their physical and cognitive needs.

To access Ease of Access Center, do the following:

1. Go to Control Panel, and ensure that you view Control Panel using Category.
2. Click **Ease of Access → Ease of Access Center**.
3. Choose the appropriate tool by following the instructions on the screen.

Ease of Access Center mainly includes the following tools:

- **Magnifier**
Magnifier is a useful utility that enlarges the entire screen or part of the screen so that you can see the items better.
- **Narrator**
Narrator is a screen reader that reads what is displayed on the screen aloud and describes events such as error messages.
- **On-Screen Keyboard**

If you prefer to type or enter data into your computer using a mouse, joystick, or other pointing device instead of a physical keyboard, you can use On-Screen Keyboard. On-Screen Keyboard displays a visual keyboard with all the standard keys. You can select keys using the mouse or another pointing device, or you can tap to select the keys if your computer supports multi-touch screen.

- **High Contrast**

High Contrast is a feature that heightens the color contrast of some text and images on your screen. As a result, those items are more distinct and easier to identify.

- **Personalized keyboard**

Adjust keyboard settings to make your keyboard easier to use. For example, you can use your keyboard to control the pointer and make the keyboard easier to type certain key combinations.

- **Personalized mouse**

Adjust mouse settings to make your mouse easier to use. For example, you can change the pointer appearance and make your mouse easier to manage windows.

Speech Recognition

Speech Recognition enables you to control your computer by voice.

Using only your voice, you can start programs, open menus, click objects on the screen, dictate text into documents, and write and send e-mails. Everything you do with the keyboard and mouse can be done with only your voice.

To use Speech Recognition, do the following:

1. Go to Control Panel, and ensure that you view Control Panel by Category.
2. Click **Ease of Access → Speech Recognition**.
3. Follow the instructions on the screen.

Screen-reader technologies

Screen-reader technologies are primarily focused on software program interfaces, help systems, and various online documents. For additional information about screen readers, see the following:

- Using PDFs with screen readers:
<https://www.adobe.com/accessibility.html?promoid=DJGVE>
- Using the JAWS screen reader:
<https://www.freedomscientific.com/Products/Blindness/JAWS>
- Using the NVDA screen reader:
<https://www.nvaccess.org/>

Screen resolution

You can make the text and images on your screen easier to read by adjusting the screen resolution of your computer.

To adjust the screen resolution, do the following:

1. Right-click an empty area of the desktop and do the following:
 - **For Windows 7:** Click **Screen resolution**.
 - **For Windows 10:** Click **Display settings → Display**.
2. Follow the instructions on the screen.

Note: Setting a resolution too low might prevent some items from fitting on the screen.

Customizable item size

You can make the items on your screen easier to read by changing the item size.

- To change the item size temporarily, use the Magnifier tool in Ease of Access Center.
- To change the item size permanently, do the following:
 - Change the size of all the items on your screen.
 - **For Windows 7:**
 1. Go to Control Panel, and ensure that you view Control Panel by Category.
 2. Click **Appearance and Personalization → Display**.
 3. Change the item size by following the instructions on the screen.
 4. Click **Apply**. This change will take effect the next time you log in to the operating system.
 - **For Windows 10:**
 1. Right-click an empty area of the desktop and then click **Display settings → Display**.
 2. Change the item size by following the instructions on the screen. For some applications, your configuration might not take effect until you sign out and then sign in again.
 - Change the size of the items on a Web page.

Press and hold Ctrl, and then press the plus-sign key (+) to enlarge or the minus-sign key (–) to reduce the text size.
 - Change the size of the items on the desktop or a window.

Note: This function might not work on some windows.

If your mouse has a wheel, press and hold Ctrl, and then scroll the wheel to change the item size.

Industry-standard connectors

Your computer provides industry-standard connectors that enable you to connect assistive devices.

Documentation in accessible formats

Lenovo provides electronic documentation in accessible formats, such as properly tagged PDF files or HyperText Markup Language (HTML) files. Lenovo electronic documentation is developed to ensure that visually impaired users can read the documentation through a screen reader. Each image in the documentation also includes adequate alternative text so that visually impaired users can understand the image when they use a screen reader.

Ergonomic information

Good ergonomic practice is important to get the most from your personal computer and to avoid discomfort. Arrange your workplace and the equipment you use to suit your individual needs and the kind of work that you perform. In addition, use healthy work habits to maximize your performance and comfort when using your computer.

Working in the virtual office might mean adapting to frequent changes in your environment. Adapting to the surrounding light sources, active seating, and the placement of your computer hardware, can help you improve your performance and achieve greater comfort.

This example shows someone in a conventional setting. Even when not in such a setting, you can follow many of these tips. Develop good habits, and they will serve you well.



General posture: Make minor modifications in your working posture to deter the onset of discomfort caused by long periods of working in the same position. Frequent short breaks from your work also help to prevent minor discomfort associated with your working posture.

Display: Position the display to maintain a comfortable viewing distance of 510 mm to 760 mm (20 inches to 30 inches). Avoid glare or reflections on the display from overhead lighting or outside sources of light. Keep the display screen clean and set the brightness to levels that enable you to see the screen clearly. Press the brightness control keys to adjust display brightness.

Head position: Keep your head and neck in a comfortable and neutral (vertical, or upright) position.

Chair: Use a chair that gives you good back support and seat height adjustment. Use chair adjustments to best suit your comfort posture.

Arm and hand position: If available, use chair arm rests or an area on your working surface to provide weight support for your arms. Keep your forearms, wrists, and hands in a relaxed and neutral (horizontal) position. Type with a soft touch without pounding the keys.

Leg position: Keep your thighs parallel to the floor and your feet flat on the floor or on a footrest.

What if you are traveling?

It might not be possible to observe the best ergonomic practices when you are using your computer while on the move or in a casual setting. Regardless of the setting, try to observe as many of the tips as possible. Sitting properly and using adequate lighting, for example, helps you maintain desirable levels of comfort and performance. If your work area is not in an office setting, ensure to take special note of employing active sitting and taking work breaks. Many ThinkPad product solutions are available to help you modify and expand your computer to best suit your needs. You can find some of these options at <https://www.lenovo.com/accessories>. Explore your options for docking solutions and external products that provide the adjustability and features that you want.

Questions about vision?

The visual display screens of ThinkPad notebook computers are designed to meet the highest standards. These visual display screens provide you with clear, crisp images and large, bright displays that are easy to see, yet easy on the eyes. Any concentrated and sustained visual activity can be tiring. If you have questions on eye fatigue or visual discomfort, consult a vision-care specialist for advice.

Cleaning and maintenance

With appropriate care and maintenance your computer will serve you reliably. The following topics offer information to help you keep your computer in top working order.

Basic maintenance tips

Here are some basic points about keeping your computer functioning properly:

- Store packing materials safely out of the reach of children to prevent the risk of suffocation from plastic bags.
- Keep your computer away from magnets, activated cellular phones, electrical appliances, or speakers (more than 13 cm or 5 inches).
- Avoid subjecting your computer to extreme temperatures (below 5°C/41°F or above 35°C/95°F).
- Avoid placing any objects (including paper) between the display and the keyboard or the palm rest.
- Your computer display is designed to be opened and used at an angle slightly greater than 90 degrees. Do not open the display beyond 180 degrees. Otherwise, the computer hinge might get damaged.
- Do not turn your computer over when the ac power adapter is plugged in, otherwise, it could break the adapter plug.
- Before moving your computer, be sure to remove any media, turn off attached devices, and disconnect cords and cables.
- When picking up your open computer, hold it by the bottom. Do not pick up or hold your computer by the display.
- Only an authorized ThinkPad repair technician should disassemble and repair your computer.
- Do not modify or tape the latches to keep the display open or closed.
- Avoid directly exposing your computer and peripherals to the air from an appliance that can produce negative ions. Wherever possible, ground your computer to facilitate safe electrostatic discharge.

Cleaning your computer

It is a good practice to clean your computer periodically to protect the surfaces and ensure trouble-free operation.

Cleaning the computer cover: Wipe it with a lint-free cloth dampened in mild soap and water. Avoid applying liquids directly to the cover.

Cleaning the keyboard: Wipe the keys one by one with a lint-free cloth dampened in mild soap and water. If you wipe several keys at a time, the cloth might hook onto an adjacent key and possibly damage it. Avoid spraying cleaner directly onto the keyboard. To remove any crumbs or dust from beneath the keys, you can use a camera blower with a brush or use cool air from a hair dryer.

Cleaning the computer screen: Scratches, oil, dust, chemicals, and ultraviolet light can affect the performance of your computer screen. Use a dry, soft lint-free cloth to wipe the screen gently. If you see a scratchlike mark on your screen, it might be a stain. Wipe or dust the stain gently with a soft, dry cloth. If the stain remains, moisten a soft, lint-free cloth with water or eyeglass cleaner, but do not apply liquids directly to your computer screen. Ensure that the computer screen is dry before closing it.

Chapter 5. Security

This chapter provides information about how to protect your computer from unauthorized use.

Using passwords

This topic provides information about how to use the power-on password, supervisor password, and hard disk password.

Passwords introduction

You can help prevent your computer from unauthorized use by using passwords. After you set a password, a prompt is displayed on the screen each time you turn on the computer. Enter your password at the prompt. You cannot use the computer unless you type the correct password.

If you have set a power-on password, a supervisor password, or a hard disk password, it unlocks automatically when the computer resumes from sleep mode.

Note: If a Windows password has been set, you are prompted to enter it when the computer resumes from sleep mode.

Power-on password

You can set a power-on password to help protect your computer against unauthorized access.

If you set a power-on password, the password prompt is displayed on the screen whenever you turn on the computer. You must enter the correct password to start using the computer.



When this icon is displayed, type a power-on password or a supervisor password.

Supervisor password

The supervisor password protects the system information stored in the ThinkPad Setup program. It provides the following security features:

- If only a supervisor password is set, a password prompt is displayed when you try to start the ThinkPad Setup program. Unauthorized users cannot change most of the system configuration options in the ThinkPad Setup program without the password.
- The system administrator can use the supervisor password to access a computer even if the user of that computer has set a power-on password. The supervisor password overrides the power-on password.
- The system administrator can set the same supervisor password on many ThinkPad notebook computers to make administration easier.

Hard disk passwords

Setting a hard disk password prevents unauthorized access to the data on the hard disk drive. When a hard disk password is set, you are prompted to type a valid password each time you try to access the hard disk drive.

The following two types of hard disk passwords can help protect the information stored on the storage drive:



- **User hard disk password**

If a user hard disk password has been set, but no master hard disk password has been set, the user must enter the user hard disk password to access files and applications on the storage drive.

- **Master hard disk password**

The master hard disk password also requires a user hard disk password. The master hard disk password is set and used by a system administrator. It enables the administrator to access any storage drive in a system like a master key. The administrator sets the master password; then assign a user password for each computer in the network. The user can then change the user password as desired, but the administrator still can get access by using the master password.

When a master hard disk password is set, only the administrator can remove the user hard disk password.

When this icon  is displayed, type a user hard disk password. To type a master hard disk password, press F1. When the icon changes to , type the master hard disk password. To return to the icon , press F1 again.

Tips on using the hard disk passwords:

- You can set the minimum length of a hard disk password.
- If you set a hard disk password of over seven characters, the storage drive can be used only with a computer that can recognize a hard disk password of over seven characters. If you then install the storage drive in a computer that cannot recognize a hard disk password that contains more than seven characters, you cannot access the drive.

Notes: The eDrive storage drives or Trusted Computing Group (TCG) Opal-compliant storage drives provide self-encryption capabilities to secure your data.

- If a TCG Opal-compliant storage drive and a TCG Opal management software program are installed, and the TCG Opal management software program is activated, the hard disk password is not available.
- If an eDrive storage drive is installed in your computer, and your computer is preinstalled with the Windows 10 operating system, the hard disk password is not available.

Setting, changing, or removing a password

Before you start, print these instructions.

To set, change, or remove a password, do the following:

1. Restart the computer. When the logo screen is displayed, press F1 to start the ThinkPad Setup program.
2. Select **Security** → **Password** by using the directional keys.
3. Depending on the password type, select **Power-on Password**, **Supervisor Password**, or **Hard disk x Password**.
4. Follow the instructions on the screen to set, change, or remove a password.

You should record all your passwords and store them in a safe place. If you forget any of your passwords, any potential repair actions required are not covered under warranty.

What to do if you forget your power-on password

If you forget your power-on password, do the following to remove the power-on password:

- If you have set a supervisor password and remember it:
 1. Restart the computer. When the logo screen is displayed, immediately press F1.
 2. Type the supervisor password to enter the UEFI BIOS menu.

3. Select **Security → Password → Power-On Password** by using the arrow keys.
 4. Type the current supervisor password in the **Enter Current Password** field. Then, leave the **Enter New Password** field blank, and press Enter twice.
 5. In the Changes have been saved window, press Enter.
 6. Press F10 to save changes and exit the UEFI BIOS menu.
- If you have not set a supervisor password, contact a Lenovo authorized service provider to have the power-on password removed.

What to do if you forget your hard disk password

If you forget your user hard disk password or both user and master hard disk passwords, Lenovo cannot reset your passwords or recover data from the storage drive. You can contact a Lenovo authorized service provider to have the storage drive replaced. A fee will be charged for parts and service. If the storage drive is a CRU (Customer Replaceable Unit), you can also contact Lenovo to purchase a new storage drive to replace the old one by yourself. To check whether the storage drive is a CRU and the relevant replacement procedure, see Chapter 10 “Replacing devices” on page 109.

What to do if you forget your supervisor password

If you forget your supervisor password, there is no service procedure to remove the password. You have to contact a Lenovo authorized service provider to have the system board replaced. A fee will be charged for parts and service.

Hard disk security

To protect the computer from unauthorized security attacks, refer to the following tips to enhance security:

- Set a power-on password as well as a hard disk password. For security, a longer password is recommended.
- The hard disk drive built into your computer can be protected by UEFI BIOS. To provide reliable security, use the security chip and a security program with the Trusted Platform Module (TPM) management feature. See “Setting the security chip” on page 56.
- If a Disk Encryption storage drive is installed in your computer, ensure to protect the contents of your computer from unauthorized access by use of drive encryption software, such as Microsoft Windows BitLocker® Drive Encryption.
- Before you dispose of, sell, or hand over your computer, delete the data stored on it. For more information, see “Deleting data from your storage drive” on page 58.

Using Windows BitLocker Drive Encryption

To help protect your computer against unauthorized access, use the drive encryption software, such as Windows BitLocker Drive Encryption.

Windows BitLocker Drive Encryption (referred to as BitLocker) is an integral security feature of some editions of the Windows operating system. It can help you protect the operating system and data stored on your computer, even if your computer is lost or stolen. BitLocker can encrypt all user and system files, including the swap and hibernation files.

BitLocker uses the TPM to provide enhanced protection for your data and to ensure early boot component integrity. A compatible TPM is defined as a V1.2 TPM (Windows 7 32-bit) or V2.0 TPM (Windows 7 64-bit and Windows 10).

To check the BitLocker status, go to Control Panel, view Control Panel by Category, and click **System and Security → BitLocker Drive Encryption**.

For more information, see the help system of the Windows operating system, or search for “Microsoft Windows BitLocker Drive Encryption Step-by-Step Guide” on the Microsoft Web site.

Disk Encryption hard disk drive and Encryption solid-state drive

Some models contain the Disk Encryption hard disk drive, Encryption solid-state drive, or Encryption hybrid drive. This encryption technology helps to protect your computer against security attacks on media, NAND flash, or device controllers by use of a hardware encryption chip. For the efficient use of the encryption feature, set a hard disk password for the internal storage drive.

Setting the security chip

Strict security requirements are imposed on network client computers that transfer confidential information electronically. Depending on the options you ordered, your computer might have an embedded security chip (a cryptographic microprocessor). With the security chip, you can do the following:

- Protect your data and system
- Strengthen access controls
- Secure communications

Before you start, print these instructions.

To set an item on the **Security Chip** submenu, do the following:

1. Restart the computer. When the logo screen is displayed, press F1 to start the ThinkPad Setup program.
2. Select **Security** → **Security Chip** by using the directional keys.
3. Press Enter. The **Security Chip** submenu opens.
4. Move to an item you want to set by using the directional keys. When the item is highlighted, press Enter.
5. Set other items that you want to set.
6. Press F10. A Setup Confirmation window is displayed. Select **Yes** to save the configuration changes and exit.

Notes:

- Ensure that the supervisor password has been set in ThinkPad Setup. Otherwise anyone can change the settings for the security chip.
- When you clear the security chip, turn off your computer and then turn it on again after you set the security chip to **Active**. Otherwise, the **Clear Security Chip** option is not displayed.

Using the fingerprint reader

Depending on the model, your computer might have a fingerprint reader. Fingerprint authentication can replace your passwords, such as the Windows password, power-on password, and hard disk password. In this way, you can log in to your computer simply and securely.

Enrolling your fingerprints

To enable fingerprint authentication, enroll your fingerprints first. During the enrollment, the fingerprints are associated with the Windows password automatically. It is recommended that you enroll more than one fingerprint in case of any injuries to your fingers.

To enroll your fingerprints, do the following:

- **For Windows 7**

1. Start the fingerprint program. For instructions on how to start the fingerprint program, see “Accessing Lenovo programs” on page 14.
2. Enter the Windows password as required.
3. Follow the instructions on the screen to finish the enrollment.

For more information about how to use the fingerprint reader, refer to the help system of the fingerprint program.

- **For Windows 10**

1. Open the Start menu and then click **Settings** → **Accounts** → **Sign-in options**.
2. Follow the instructions on the screen to finish the enrollment.

Scanning your finger

To scan your finger, tap the fingerprint reader with the top joint of your finger and hold your finger there for one or two seconds with a little pressure. Then lift the finger to complete one scan.

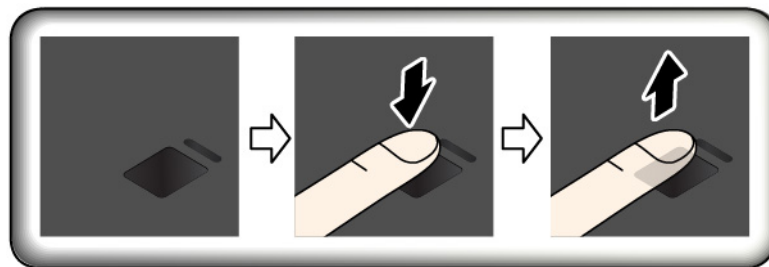

Fingerprint reader indicator

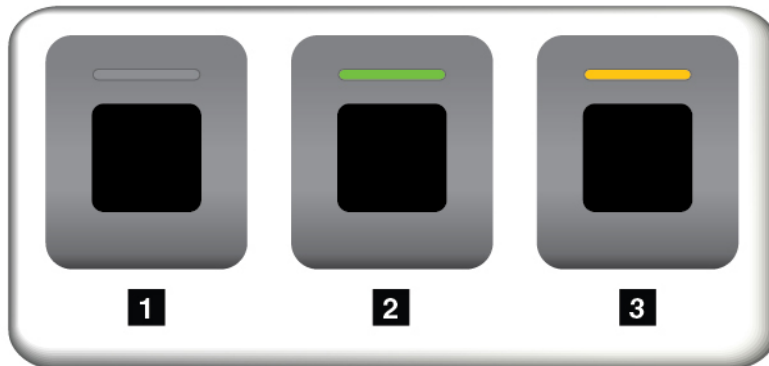

- 1** Off: The fingerprint reader is not ready for tapping.
- 2** Solid green: The fingerprint reader is ready for tapping.
- 3** Amber, blinking: The fingerprint cannot be authenticated.

Associating your fingerprints with your power-on password and hard disk password

To associate your fingerprints with your power-on password and hard disk password, manually create a connection by doing the following:

1. Turn off and then turn on the computer.
2. When prompted, scan your finger on the fingerprint reader.
3. Enter your power-on password, hard disk password, or both as required. The connection is created.

When you start the computer again, you can use your fingerprints to log in to the computer with no need to enter your Windows password, power-on password, and hard disk password. To change the settings, go to ThinkPad Setup program. See “Using the ThinkPad Setup program” on page 64.

Maintaining the fingerprint reader

The following actions could damage the fingerprint reader or cause it not to work correctly:

- Scratching the surface of the reader with a hard, pointed object
- Scraping the surface of the reader with your fingernail or anything hard
- Using or touching the reader with a dirty finger

If you notice any of the following conditions, gently clean the surface of the reader with a dry, soft, lint-free cloth:

- The surface of the reader is dirty or stained.
- The surface of the reader is wet.
- The reader often fails to enroll or authenticate your fingerprint.

If your finger has any of the following conditions, you might not be able to register or authenticate it:

- Your finger is wrinkled.
- Your finger is rough, dry, or injured.
- Your finger is stained with dirt, mud, or oil.
- The surface of your finger is different from the one when you enrolled your fingerprint.
- Your finger is wet.
- Your finger that you are currently using has not been enrolled before.

To improve the situation, try the following:

- Clean or wipe your hands to remove any excess dirt or moisture from the fingers.
- Enroll and use a different finger for authentication.

Deleting data from your storage drive

Some of the data stored on the storage drive might be sensitive. Handing your computer over to someone else without deleting the installed software, such as operating systems and programs, might even violate the license agreements. Be sure to delete data stored on the storage drive before you dispose of, sell, or hand over your computer.

You can use the following methods to delete data from the storage drive:

- Move the data to the Recycle Bin, and then empty the Recycle Bin.
- Format your storage drive, using the software to initialize it.
- Use the recovery program provided by Lenovo to bring the storage drive back to the factory default settings.

These operations, however, only change the file location of the data; they do not delete the data itself. The data is still there, even though it seems to be lost. Thus, it is sometimes possible to read the data by use of special software for data recovery. There is a risk that people of bad faith might read and misuse the critical data on storage drives for unexpected purposes.

To prevent leakage of data, it is important that you delete all the data from the hard disk drive when you dispose of, sell, or hand over your computer. You can destroy the data physically by smashing the hard disk drive with a hammer, or magnetically by means of strong magnetic power, thus making the data unreadable. But it is recommended that you use the software (payware) or service (pay service) developed for that purpose. The process might take several hours.

For disposing of data on the solid-state drive, Lenovo provides the Drive Erase Utility for Resetting the Cryptographic Key and Erasing the Solid State Drive tool.

Some computers might support a Disk Encryption hard disk drive or Encryption solid-state drive and have such a drive installed. You can logically dispose of all the data on the drive in a short time by erasing the cryptographic key. The data encrypted with the old key is not physically erased but remains on the drive; however, it cannot be decrypted without the old key. This feature is also available with the Drive Erase Utility for Resetting the Cryptographic Key and Erasing the Solid State Drive tool.

Using firewalls

If your system is preinstalled with a firewall program, it protects against computer Internet security threats, unauthorized access, intrusions, and Internet attacks. It also protects your privacy.

For more information about how to use the firewall program, see the help system that comes with the program.

Protecting data against viruses

Lenovo provides a full version of antivirus software on your computer with a free 30-day subscription. After 30 days, you must renew the license to continue receiving the antivirus software updates.

For more information about your antivirus software, see the help system of your antivirus software.

Chapter 6. Advanced configuration

This chapter provides information to help you further configure the computer:

Installing a new operating system

In some situations, you might need to install a new operating system. This topic provides instructions on how to install a new operating system.

Installing a Windows 7 operating system

Before you start, print these instructions.

Attention:

- It is recommended that you update your operating system through official channels. Any unofficial update might cause security risks.
- The process of installing a new operating system deletes all the data on your internal storage drive, including the data that were stored in a hidden folder.

To install a Windows 7 operating system, do the following:

1. Ensure that you set the security chip to correct value:

- Windows 7 (32-bit) operating system: TPM 1.2
- Windows 7 (64-bit) operating system in Legacy mode: TPM 1.2
- Windows 7 (64-bit) operating system in UEFI mode: TPM 2.0

For more information, see “Setting the security chip” on page 56.

2. Copy all the subfolders and files at C:\SWTOOLS to a removable storage device.

- The supplement files for the Windows 7 operating system are at C:\SWTOOLS\OSFIXES.
- The device drivers are at C:\SWTOOLS\DRIVERS.
- The preinstalled programs are at C:\SWTOOLS\APPS.

3. Start the ThinkPad Setup program. See “Configuring ThinkPad Setup” on page 64.

4. Select **Startup → Boot** to display the **Boot Priority Order** submenu.

5. Select the drive that contains the operating system installation program, for example, **USB HDD**. Then press Esc.

6. Select **Startup → UEFI/Legacy Boot**. Then do one of the following:

- To install a Windows 7 (32-bit) operating system, select **Legacy Only** or **Both**.
- To install a Windows 7 (64-bit) operating system in Legacy mode, select **Legacy Only**.
- To install a Windows 7 (64-bit) operating system in UEFI mode, select **UEFI Only**.

Notes:

- For computers with a non-volatile memory (NVM) Express drive, you can install the Windows 7 operating system onto the drive only in UEFI mode. In this case, ensure that you always select **UEFI Only**.
- TPM 2.0 is supported only on the Windows 7 (64-bit) operation system in UEFI mode. If you install the Windows 7 (64-bit) operating system in Legacy mode, ensure that you set the security chip to TPM 1.2.

7. Press F10 to save the settings and exit the ThinkPad Setup program.
8. Connect an external DVD drive to the computer, insert the Windows 7 operating system installation DVD into the drive, and then restart the computer.

Notes:

- If you start the installation DVD image from an external USB device or if your computer has an NVM Express drive installed, do additional configurations before you start. For more information, go to <https://support.lenovo.com/us/en/solutions/ht103541>.
- If an NVM Express drive is installed, additional drivers also are required. For more information, go to <https://support.microsoft.com/en-us/kb/2990941>.

9. Restore the folder at C:\SWT00LS that you backed up.
10. Install the device drivers. See “Installing device drivers” on page 63.
11. Install the Windows 7 fix modules. You can find the Windows 7 fix modules at C:\SWT00LS\0SFIXES\. For more information, go to the Microsoft Knowledge Base home page at <https://support.microsoft.com/>.
12. Install the registry patches, for example, the Enabling Wake on LAN from Standby for ENERGY STAR patch. To download and install the registry patches, go to the Lenovo Support Web site at <https://support.lenovo.com>.

Note: After installing the operating system, do not change the initial **UEFI/Legacy Boot** setting in the ThinkPad Setup program. Otherwise the operating system will not start correctly.

When you install a Windows 7 operating system, you might need one of the following country or region codes:

Country or region	Code	Country or region	Code
Mainland China	SC	Netherlands	NL
Denmark	DK	Norway	NO
Finland	FI	Spain	SP
France	FR	Sweden	SV
Germany	GR	Taiwan and Hong Kong	TC
Italy	IT	United States	US
Japan	JP		

Installing a Windows 10 operating system

Microsoft constantly makes updates to the Windows 10 operating system. Before installing a particular Windows 10 operating system, check the compatibility list of the Windows versions supported on the your computer. For details, go to <https://support.lenovo.com/us/en/solutions/windows-support>.

Attention:

- It is recommended that you update your operating system through official channels. Any unofficial update might cause security risks.
- The process of installing a new operating system deletes all the data on your internal storage drive, including the data that were stored in a hidden folder.

To install a Windows 10 operating system, do the following:

1. Ensure that you set the security chip to TPM 2.0. For more information, see “Setting the security chip” on page 56.

2. Connect the drive that contains the operating system installation program to the computer.
3. Start the ThinkPad Setup program. See “Using the ThinkPad Setup program” on page 64.
4. Select **Startup → Boot** to display the **Boot Priority Order** submenu.
5. Select the drive that contains the operating system installation program, for example, **USB HDD**. Then press Esc.
6. Select **Restart** and ensure that **OS Optimized Defaults** is enabled. Then press F10 to save the settings and exit the ThinkPad Setup program.
7. Follow the on-screen instructions to install the device drivers and necessary programs. See “Installing device drivers” on page 63.
8. After installing the device drivers, apply Windows Update to get the latest modules, for example the security patches.
9. Depending on your preference, install Lenovo programs. For information about Lenovo programs, see “Lenovo programs” on page 14.

Note: After installing the operating system, do not change the initial **UEFI/Legacy Boot** setting in the ThinkPad Setup program. Otherwise, the operating system will not start correctly.

When you install a Windows 10 operating system, you might need one of the following country or region codes:

Country or region	Code	Country or region	Code
Mainland China	SC	Netherlands	NL
Denmark	DK	Norway	NO
Finland	FI	Spain	SP
France	FR	Sweden	SV
Germany	GR	Taiwan and Hong Kong	TC
Italy	IT	United States	US
Japan	JP		

Installing device drivers

Device drivers are programs that contain instructions for the operating system about how to operate or “drive” a certain piece of hardware. Each hardware component on your computer has its own specific driver. If you add a component, the operating system must be instructed on how to operate that piece of hardware. After you install the driver, the operating system can recognize the hardware component and understand how to use it.

Note: Because drivers are programs, like any other file on your computer, they are susceptible to corruption and might not perform properly if corruption occurs.

It is not always necessary to download the latest drivers. However, you should download the latest driver for a component when you notice poor performance from that component or when you added a component. This action might eliminate the driver as the potential cause of a problem.

Getting the latest drivers from the Web site

You can download and install updated device drivers from the Lenovo Support Web site by doing the following:

1. Go to <https://support.lenovo.com>.

2. Select the entry for your computer and then follow the instructions on the screen to download and install necessary software.

Getting the latest drivers using preinstalled programs

ThinkPad notebook computers provide the following preinstalled programs that you can use to download and install updated device drivers.

- **For Windows 7:** System Update
- **For Windows 10:** Lenovo Vantage

The system update function of System Update or Lenovo Vantage helps you keep the software on your computer up-to-date. Update packages are stored on Lenovo servers and can be downloaded from the Lenovo Support Web site. Update packages can contain applications, device drivers, UEFI BIOS flashes, or software updates. When System Update or Lenovo Vantage connects to the Lenovo Support Web site, the program automatically recognizes the following information and determines what updates are available for your computer:

- Machine type and model of your computer
- Installed operating system
- Language of the operating system

System Update or Lenovo Vantage then displays a list of update packages and categorizes each update as critical, recommended, or optional to help you understand the importance. You have complete control of which updates to download and install. After you select the update packages you want, System Update or Lenovo Vantage automatically downloads and installs the updates.

System Update or Lenovo Vantage is preinstalled on your computer and is ready to run. The only prerequisite is an active Internet connection. You can start the program manually, or you can use the schedule feature to enable the program to search for updates automatically at specified intervals. You also can predefine scheduled updates to search by the following severity so the list you choose from contains only those update types that you need:

- Critical updates (Windows 7 and Windows 10)
- Critical and recommended updates (Windows 7)

For more information about how to use System Update or Lenovo Vantage, see the help system of the program.

Using the ThinkPad Setup program

The ThinkPad Setup program enables you to select the preferred settings for your computer through configuring the BIOS.

Configuring ThinkPad Setup

The ThinkPad Setup program menu lists various items about system configuration.

Attention: The default configurations are already optimized for you. Improper change of the configurations might cause unexpected results.

To configure ThinkPad Setup, do the following:

1. Restart the computer. When the logo screen is displayed, press F1. The ThinkPad Setup program starts.

Note: If you are required to enter the supervisor password, enter the correct password. You also can press Enter to skip the password prompt and start the ThinkPad Setup program. If you do not enter the password, you cannot change the configurations that are protected by the supervisor password.

2. Use the arrow keys to select a tab; or use the arrow keys to locate an item and press Enter to select it. Then the supported submenu is displayed.
3. Default values are in **boldface**. Set the value of an item by doing one of the following:
 - Press F6 to change to a higher value.
 - Press F5 to change to a lower value.
4. Press the Esc key to exit the submenu and return to the parent menu. Then use the same method mentioned above to change other configurations.
5. When you complete the configuration, press F10 to save and exit. You also can select the **Restart** tab in the ThinkPad Setup menu, and restart your computer with one of the provided options.

You can press F9 to restore to the default settings.

Changing the startup sequence

In some cases, you might have to change the startup sequence so that the computer starts from a desired device when powered on. Read this topic to learn how to change the computer startup sequence.

Attention:

- After you change the startup sequence, ensure that you select the correct device during a copy, a save, or a format operation. If you select the wrong device, the data on that device might be erased or overwritten.
- If you are using the Windows BitLocker Drive Encryption feature and your computer has a Trusted Platform Module, do not change the startup sequence. BitLocker Drive Encryption locks the computer when it detects the change of startup sequence.

To change the startup sequence, do the following:

1. Access the ThinkPad Setup program and select **Startup → Boot**. Then press Enter. The default device order list is displayed.
2. Set the startup sequence as you desired.
3. Press F10 to save the changes and restart the system.

You also can change the startup sequence temporarily by doing the following:

1. Turn off the computer.
2. Turn on the computer. When the logo screen is displayed, press the F12 key.
3. Select the device that you want the computer to start from. Then press Enter.

Note: The **Boot** menu will be displayed if the computer cannot start from any devices or the operating system cannot be found.

Updating the UEFI BIOS

The UEFI BIOS is the first program that the computer runs when the computer is turned on. The UEFI BIOS initializes the hardware components, and loads the operating system and other programs.

When you install a new program, device driver, or hardware component, you might be informed to update the UEFI BIOS. You can update the UEFI BIOS by starting your computer from a flash update disc or a flash update program running in the Windows environment.

The requirements for flash update are as follows:

- The computer must be started over LAN.
- The computer must be engaged in the Preboot eXecution Environment (PXE).
- A network-management program must be installed on the computer of the network administrator.

For instructions on how to update the UEFI BIOS, go to <https://support.lenovo.com>.

BIOS menu

This topic introduces the following BIOS menus of your computer:

- Main menu
- Config menu
- Date/Time menu
- Security menu
- Startup menu
- Restart menu

Note: Depending on the model and operating system, the menu items and the default value might change without notice.

Main menu

When you enter the ThinkPad Setup program, the **Main** menu is displayed with the following information:

- UEFI BIOS Version
- UEFI BIOS Date
- Embedded Controller Version
- ME Firmware Version
- Machine Type Model
- System-unit serial number
- System board serial number
- Asset Tag
- CPU Type
- CPU Speed
- Installed Memory
- UUID
- MAC Address (Internal LAN)
- Preinstalled operating system license
- UEFI Secure Boot
- OA3 ID
- OA2

Config menu

To change the configuration of your computer, select the **Config** tab from the ThinkPad Setup menu.

The following table lists the **Config** menu items. Default values are in **boldface**. The menu items might change without notice. Depending on the model, the default value might vary.

Attention: The default configurations are already optimized for you. Improper change of the configurations might cause unexpected results.

Table 1. Config menu items

Menu item	Submenu item	Value	Comments
Network	Wake On LAN	<ul style="list-style-type: none"> • Disabled • AC only • AC and Battery 	<p>Enable the computer to power on when the Ethernet controller receives a magic packet (a special network message).</p> <p>If you select AC Only, Wake on LAN is enabled only when the ac power adapter is attached.</p> <p>If you select AC and Battery, Wake on LAN is enabled with any power sources.</p> <p>Notes:</p> <ul style="list-style-type: none"> • The magic packet type Wake on LAN requires ac power. • The Wake on LAN function does not work when a hard disk password is set.
	Ethernet LAN Option ROM (for Legacy Only boot mode or Both with Legacy first)	<ul style="list-style-type: none"> • Disabled • Enabled 	Load the Ethernet LAN Option ROM to enable startup from an integrated network device.
	UEFI IPv4 Network Stack (for UEFI Only boot mode or Both with UEFI first)	<ul style="list-style-type: none"> • Disabled • Enabled 	Enable or disable Internet Protocol Version 4 (IPv4) network stack for UEFI environment.
	UEFI IPv6 Network Stack (for UEFI Only boot mode or Both with UEFI first)	<ul style="list-style-type: none"> • Disabled • Enabled 	Enable or disable Internet Protocol Version 6 (IPv6) network stack for UEFI environment.
	UEFI PXE Boot Priority (for UEFI Only boot mode or Both with UEFI first for boot capability and IPv6 and IPv4 stacks are both enabled.)	<ul style="list-style-type: none"> • IPv6 First • IPv4 First 	Select network stack priority for UEFI PXE boot.
USB	USB UEFI BIOS Support	<ul style="list-style-type: none"> • Disabled • Enabled 	Enable or disable boot support for USB storage devices.

Table 1. Config menu items (continued)

Menu item	Submenu item	Value	Comments
	Always On USB	<ul style="list-style-type: none"> • Disabled • Enabled 	<p>If you select Enabled, the external USB devices can be charged through USB connectors even when the computer is in low-power mode (sleep, hibernate, or power-off).</p> <p>Note: If you select Enabled, USB wake up function is not supported on Always On USB connector.</p>
	– Charge in Battery Mode	<ul style="list-style-type: none"> • Disabled • Enabled 	<p>If you select Enabled, the external USB devices can be charged through USB connectors even when system is in hibernation or power-off mode and in battery mode.</p>
Keyboard/Mouse	TrackPoint	<ul style="list-style-type: none"> • Disabled • Enabled 	<p>Enable or disable the built-in TrackPoint pointing device.</p> <p>Note: If you want to use an external mouse, select Disabled.</p>
	Trackpad	<ul style="list-style-type: none"> • Disabled • Enabled 	<p>Enable or disable the built-in trackpad.</p> <p>Note: If you want to use an external mouse, select Disabled.</p>
	Fn and Ctrl Key swap	<ul style="list-style-type: none"> • Disabled • Enabled 	<p>Enable exchanges of Fn and Ctrl key action at the bottom-left of the keyboard.</p> <p>Disabled: Fn key and Ctrl key behavior is as printed on the keyboard.</p> <p>Enabled: Fn key works as Ctrl key. Ctrl key works as Fn key.</p>

Table 1. Config menu items (continued)

Menu item	Submenu item	Value	Comments
	F1–F12 as primary function	<ul style="list-style-type: none"> • Disabled • Enabled 	<p>Enable the F1-F12 function or the special function printed as an icon on each key as the primary function.</p> <p>Enabled: Executes the F1-F12 function.</p> <p>Disabled: Executes the special function.</p> <p>To temporarily switch the above two options, press Fn+Esc to enable FnLock. The FnLock indicator is on when FnLock is enabled.</p>
	Fn Sticky key	<ul style="list-style-type: none"> • Disabled • Enabled 	<p>When the option is enabled, you can press the Fn key to keep it in a pressed condition; then press the desired function key. The action is equivalent to pressing the required key simultaneously with the Fn key. When you press the Fn key twice, the state is locked until you press the Fn key again.</p>
Display	Boot Display Device	<ul style="list-style-type: none"> • ThinkPad LCD • Analog (VGA) • Digital on ThinkPad • Display on dock 	<p>Select the display device that is to be activated at boot time. This selection is effective for boot time, password prompt, and ThinkPad Setup.</p> <p>Digital on ThinkPad is the Mini DisplayPort on your computer.</p> <p>Display on dock is DisplayPort, DVI or VGA connectors on a docking station.</p>
	Graphics Device	<ul style="list-style-type: none"> • Discrete Graphics • Hybrid Graphics 	<p>Enable the Discrete Graphics mode or the Hybrid Graphics mode.</p> <p>Discrete Graphics mode provides better graphics performance.</p> <p>Hybrid Graphics mode works as integrated graphics and it consumes less battery power.</p>

Table 1. Config menu items (continued)

Menu item	Submenu item	Value	Comments
	Total Graphics Memory	<ul style="list-style-type: none"> • 256 MB • 512 MB 	<p>Allocate the total memory which Intel internal graphics shares.</p> <p>Note: If you select 512 MB, the maximum usable memory might be reduced on 32-bit operating system.</p>
	Boot Time Extension	<ul style="list-style-type: none"> • Disabled • 1 second • 2 seconds • 3 seconds • 5 seconds • 10 seconds 	<p>This option defines the amount of time to extend the boot process, in seconds.</p> <p>The system cannot detect some external monitors during boot because the external monitors might need a few seconds to be ready. Try this option if the external monitor being used does not display the boot screen.</p>
Power	Intel SpeedStep® technology (Intel SpeedStep mounted models only)	<ul style="list-style-type: none"> • Disabled • Enabled <p>Mode for AC</p> <ul style="list-style-type: none"> • Maximum Performance • Battery Optimized <p>Mode for Battery</p> <ul style="list-style-type: none"> • Maximum Performance • Battery Optimized 	<p>Select the mode of Intel SpeedStep technology at runtime.</p> <p>Maximum Performance: Always highest speed.</p> <p>Battery Optimized: Always lowest speed.</p> <p>Disabled: No runtime support, highest speed.</p>
	Adaptive Thermal Management	<p>Scheme for AC</p> <ul style="list-style-type: none"> • Maximize Performance • Balanced <p>Scheme for Battery</p> <ul style="list-style-type: none"> • Maximize Performance • Balanced 	<p>Select a thermal management scheme to use.</p> <p>Maximize Performance: Reduce microprocessor throttling.</p> <p>Balanced: Balance sound, temperature, and performance.</p> <p>Note: Each scheme affects fan sound, temperature, and performance.</p>
	Optical Drive Speed	<ul style="list-style-type: none"> • High Performance • Normal • Silent 	<p>Set the operating speed of the optical drive to meet your desired performance.</p>

Table 1. Config menu items (continued)

Menu item	Submenu item	Value	Comments
	CPU Power Management	<ul style="list-style-type: none"> • Disabled • Enabled 	Enable or disable the power-saving feature that stops the microprocessor clock automatically when there are no system activities. Normally, it is not necessary to change the setting.
	ExpressCard Speed	<ul style="list-style-type: none"> • Generation 1 • Automatic 	Set the transfer speed of ExpressCard to the desired performance.
	PCI Express Power Management	<ul style="list-style-type: none"> • Disabled • Enabled 	Enable or disable the feature that automatically adjusts power management when no PCI Express activity is detected.
	Power On with AC Attach	<ul style="list-style-type: none"> • Disabled • Enabled 	<p>Enable or disable a feature that powers on the system when the ac power adapter is attached.</p> <p>If you select Enabled, the system is powered on when the ac power adapter is attached. When the system is in hibernate state, the system resumes.</p> <p>If you select Disabled, the system is not powered on nor resumed when the ac power adapter is attached.</p>
Beep and Alarm	Password Beep	<ul style="list-style-type: none"> • Disabled • Enabled 	Enable this option to have a beep sound when the system is waiting for a power-on, hard disk, or supervisor password. Different beeps will sound when the entered password matches or does not match the configured password.
	Keyboard Beep	<ul style="list-style-type: none"> • Enabled • Disabled 	Enable or disable keyboard beep when unmanageable key combinations are pressed.
RAID	RAID Mode Option	<ul style="list-style-type: none"> • Disabled • Enabled 	Select the mode in which the serial SATA controller operates: Enabled: RAID mode. Disabled: AHCI mode.
	RAID Storage	<ul style="list-style-type: none"> • SATA HDD • M.2 SSD 	

Table 1. Config menu items (continued)

Menu item	Submenu item	Value	Comments
	Intel (R) Rapid Storage Technology User Interface		Enter Intel Rapid Storage Technology Configuration Utility to manage RAID volumes on the Intel RAID Controller.
Thunderbolt Reserved Memory	Thunderbolt Reserved Memory	<ul style="list-style-type: none"> • 1GB • 2GB 	<p>1GB: Each Thunderbolt connector supports connection of three devices at maximum. This selection is required for image installation and recovery.</p> <p>2GB: Each Thunderbolt connector supports connection of six devices at maximum. Do not select this option for image installation and recovery.</p>
CPU	Core Multi-Processing	<ul style="list-style-type: none"> • Enabled • Disabled 	<p>Enable: This selection enables additional execution core units within a CPU.</p> <p>Disable: This selection enables only one execution core unit within a CPU.</p>
	Intel (R) Hyper-Threading Technology	<ul style="list-style-type: none"> • Enabled • Disabled 	<p>Enable: This selection enables additional CPU threads. These Threads appear as additional processors but share some resources with the other threads within a CPU.</p> <p>Disable: This selection enables only one thread within each execution core unit.</p>

Table 1. Config menu items (continued)

Menu item	Submenu item	Value	Comments
Intel AMT	Intel (R) AMT Control	<ul style="list-style-type: none"> Disabled Enabled Permanently Disabled 	<p>If you select Enabled, Intel AMT (Active Management Technology) is configured and additional setup items are provided in MEBx (Management Engine BIOS Extension) Setup.</p> <p>If you select Permanently Disabled, you will never be able to enable it again. Be cautious when you want to use this option.</p> <p>Note: You can enter the MEBx Setup menu by pressing the Ctrl+P key combination in the Startup Interrupt Menu window. To display the Startup Interrupt Menu window, press the black button or Enter key during the power-on self-test (POST).</p>
	CIRA Timeout	0-255 Note: The default value is 60 seconds.	<p>Set the timeout option for CIRA connection to be established. Selectable second values are from 1 to 254.</p> <p>If you select 0, use 60 seconds as the default timeout value.</p> <p>If you select 255, the waiting time for establishing a connection is unlimited.</p>
	Console Type	<ul style="list-style-type: none"> PC ANSI VT100+ PC-ANSI VT-UTF8 	<p>Select the console type for AMT.</p> <p>Note: This console type should match the Intel AMT remote console.</p>

Date and Time menu

To change the date or time of your computer, select the **Date/Time** tab from the ThinkPad Setup menu. Then do the following:

1. Use the arrow keys on the keyboard to select **System Date** or **System Time**.
2. Type a date or time.

Security menu

To change the security settings of your computer, select the **Security** tab from the ThinkPad Setup menu.

The following table lists the **Security** menu items. Default values are in **boldface**. The menu items might change without notice. Depending on the model, the default value might vary.

Attention: The default configurations are already optimized for you. Improper change of the configurations might cause unexpected results.

Table 2. Security menu items

Menu item	Submenu item	Value	Comments
Password	Supervisor Password	<ul style="list-style-type: none"> • Disabled • Enabled 	See “Using passwords” on page 53.
	Lock UEFI BIOS Settings	<ul style="list-style-type: none"> • Disabled • Enabled 	Enable or disable the function that protects items in ThinkPad Setup from being changed by a user who does not have the supervisor password. By default, this is set to Disabled . If you set the supervisor password and enable this function, no one but you can change any items in ThinkPad Setup.
	Password at Unattended Boot	<ul style="list-style-type: none"> • Disabled • Enabled 	If you select and enable Password at unattended boot , a password prompt is displayed when the computer is turned on, from either a power-off state or hibernation state, by an unattended event such as a Wake on LAN attempt. If you select Disabled , no password prompt is displayed; the computer goes ahead and loads the operating system. To prevent unauthorized access, set the user authentication on the operating system.
	Password at Restart	<ul style="list-style-type: none"> • Disabled • Enabled 	If you select and enable Password at restart , a password prompt is displayed when you restart the computer. If you select Disabled , no password prompt is displayed; the computer goes ahead and loads the operating system. To prevent unauthorized access, set the user authentication on the operating system.
	Password at Boot Device List	<ul style="list-style-type: none"> • Disabled • Enabled 	If the Security password is set, this option is used to specify whether the Security password must be entered to display the F12 boot device list. Select Enabled to prompt for the Security password. Select Disabled to proceed without any user action required.
	Password Count Exceeded Error	<ul style="list-style-type: none"> • Disabled • Enabled 	Select Enabled to show the POST 0199 error and prompt for the Security password. Select Disabled to hide the POST 0199 error and proceed without any user action needed.
	Set Minimum Length	<ul style="list-style-type: none"> • Disabled • x characters (4≤x≤12) 	Specify a minimum length for power-on passwords and hard disk passwords. If you set the supervisor password and specify a minimum length for passwords, no one but you can change the length.

Table 2. Security menu items (continued)

Menu item	Submenu item	Value	Comments
	Power-On Password	<ul style="list-style-type: none"> • Disabled • Enabled 	See “Using passwords” on page 53.
	Hard Disk x Password	<ul style="list-style-type: none"> • Disabled • Enabled 	See “Using passwords” on page 53. Note: Hard Disk 1 means the hard disk drive built into your computer.
Fingerprint	Predesktop Authentication	<ul style="list-style-type: none"> • Disabled • Enabled 	Enable or disable fingerprint authentication before the operating system is loaded.
	Reader Priority	<ul style="list-style-type: none"> • External → Internal • Internal Only 	If External → Internal is selected, an external fingerprint reader is used if attached. Otherwise, an internal fingerprint reader is used. If Internal Only is selected, an internal fingerprint reader is used.
	Security Mode	<ul style="list-style-type: none"> • Normal • High 	If fingerprint authentication fails, you still can start the computer by entering a password. If you have selected Normal , enter a power-on password or a supervisor password; if you have selected High , enter a supervisor password.
	Password Authentication	<ul style="list-style-type: none"> • Disabled • Enabled 	Enable or disable password authentication. This item is displayed only if you have selected High for the Security Mode option.
	Reset Fingerprint Data	<ul style="list-style-type: none"> • Enter 	This option is used to erase all fingerprint data stored in the fingerprint reader and reset settings to the factory state. As a result, any power-on security features previously enabled will not be able to work until they are re-enabled in the fingerprint software.
Security Chip	Security Chip Selection	<ul style="list-style-type: none"> • Discrete TPM • Intel PTT 	<p>If you select Discrete TPM, you can use a discrete TPM chip with TPM 1.2 mode. If you select Intel PTT, you can use Intel Platform Trusted technology (PTT) with TPM 2.0 mode.</p> <p>If you change from Intel PTT to Discrete TPM, a message pops up warning that all encryption keys will be cleared in the security chip. If you want to continue, select Yes.</p> <p>If you change from Discrete TPM to Intel PTT, a message pops up warning that all encryption keys will be cleared in the security chip, also Intel AMT and Intel TXT will be disabled. If you want to continue, select Yes.</p> <p>Note: Intel PTT can be used with Windows 8 or later operating system.</p>

Table 2. Security menu items (continued)

Menu item	Submenu item	Value	Comments
	Security Chip	<ul style="list-style-type: none"> • Active • Inactive • Disabled (For Discrete TPM) 	<p>If you select Active, the security chip is functional. If you select Inactive, the security chip is visible, but it is not functional. If you select Disabled, the security chip is hidden and it is not functional.</p> <p>Note: This item is displayed when Security Chip Selection is set to Discrete TPM.</p>
		<ul style="list-style-type: none"> • Enabled • Disabled (For Intel PTT) 	<p>If you select Enabled, the security chip is functional. If you select Disabled, the security chip is hidden and it is not functional.</p> <p>Note: This item is displayed when Security Chip Selection is set to Intel PTT.</p>
	Clear Security Chip	<ul style="list-style-type: none"> • Enter 	<p>Clear the encryption key.</p> <p>Note: This item is displayed only if you have selected Active or Enabled for the Security Chip option.</p>
	Intel TXT Feature * Unselectable when Intel PTT is enabled.	<ul style="list-style-type: none"> • Disabled • Enabled 	<p>Enable or disable Intel Trusted Execution Technology.</p> <p>Notes:</p> <ul style="list-style-type: none"> • This item is displayed only if you have selected Active or Enabled for the Security Chip option. • This is set to disabled when Intel PTT is enabled.
	Physical Presence for Provisioning	<ul style="list-style-type: none"> • Disabled • Enabled 	<p>This option enables or disables the confirmation message when you change the settings of the security chip.</p>
	Physical Presence for Clear	<ul style="list-style-type: none"> • Disabled • Enabled 	<p>This option enables or disables the confirmation message when you clear the security chip.</p>
UEFI BIOS Update Option	Flash BIOS Updating by End-Users	<ul style="list-style-type: none"> • Disabled • Enabled 	<p>If you select Enabled, all users can update the UEFI BIOS. If you select Disabled, only the person who knows the supervisor password can update the UEFI BIOS.</p>
	Secure RollBack Prevention	<ul style="list-style-type: none"> • Disabled • Enabled 	<p>If you select Disabled, you can flash the earlier version UEFI BIOS.</p>
Memory Protection	Execution Prevention	<ul style="list-style-type: none"> • Disabled • Enabled 	<p>Some computer viruses and worms cause memory buffers to overflow. By selecting Enabled you can protect your computer against attacks by such viruses and worms. If after choosing Enabled you find that a program does not run correctly, select Disabled and reset the setting.</p>

Table 2. Security menu items (continued)

Menu item	Submenu item	Value	Comments
Virtualization	Intel Virtualization Technology	<ul style="list-style-type: none"> • Disabled • Enabled 	<p>If you select Enabled, a Virtual Machine Monitor (VMM) can utilize the additional hardware capabilities provided by Intel Virtualization Technology. This setting should be set to Disabled to prevent security risks if operating system does not support a VMM.</p> <p>Note: This item is set as Disabled by default when the OS Optimized Defaults on the Restart menu is set as Disabled. This item is set as Enabled by default when the OS Optimized Defaults is set as Enabled.</p>
	Intel VT-d Feature	<ul style="list-style-type: none"> • Disabled • Enabled 	<p>Intel VT-d stands for Intel Virtualization Technology for Directed I/O. When enabled, a VMM can utilize the platform infrastructure for I/O virtualization. This setting should be set to Disabled to prevent security risks if the operating system does not support a VMM.</p> <p>Note: This item is set as Disabled by default when the OS Optimized Defaults on the Restart menu is set as Disabled. This item is set as Enabled by default when the OS Optimized Defaults is set as Enabled.</p>
I/O Port Access	Ethernet LAN	<ul style="list-style-type: none"> • Disabled • Enabled 	If you select Enabled , you can use the Ethernet LAN device.
	Wireless LAN	<ul style="list-style-type: none"> • Disabled • Enabled 	If you select Enabled , you can use the Wireless-LAN connection.
	Wireless WAN	<ul style="list-style-type: none"> • Disabled • Enabled 	If you select Enabled , you can use the wireless-WAN device (available on some models).
	Bluetooth	<ul style="list-style-type: none"> • Disabled • Enabled 	If you select Enabled , you can use Bluetooth devices.
	USB Port	<ul style="list-style-type: none"> • Disabled • Enabled 	If you select Enabled , you can use the USB connectors.
	Ultrabay (HDD/Optical)	<ul style="list-style-type: none"> • Disabled • Enabled 	If you select Enabled , you can use the optical drive bay (available on some models).
	Memory Card Slot	<ul style="list-style-type: none"> • Disabled • Enabled 	If you select Enabled , you can use the memory slots.
	Smart Card Slot	<ul style="list-style-type: none"> • Disabled • Enabled 	If you select Enabled , you can use the smart-card slot.
	Integrated Camera	<ul style="list-style-type: none"> • Disabled • Enabled 	If you select Enabled , you can use the integrated camera.
Microphone	<ul style="list-style-type: none"> • Disabled • Enabled 	If you select Enabled , you can use the microphones (internal, external, or line-in).	

Table 2. Security menu items (continued)

Menu item	Submenu item	Value	Comments
	Fingerprint Reader	<ul style="list-style-type: none"> • Disabled • Enabled 	If you select Enabled , you can use the fingerprint reader.
	Thunderbolt	<ul style="list-style-type: none"> • Disabled • Enabled 	If you select Enabled , you can use the Thunderbolt 3 connector.
	ExpressCard Slot	<ul style="list-style-type: none"> • Disabled • Enabled 	If you select Enabled , you can use the ExpressCard slot.
	USB Type_C	<ul style="list-style-type: none"> • Disabled • Enabled 	If you select Enabled , you can use the USB Type_C feature.
Internal Device Access	Bottom Cover Tamper Detection	<ul style="list-style-type: none"> • Disabled • Enabled 	Enable or disable the tamper detection. If tamper is detected, Supervisor Password is required to boot the system. Bottom Cover Tamper Detection will not take effect unless Supervisor Password is enabled.
	Internal Storage Tamper Detection	<ul style="list-style-type: none"> • Disabled • Enabled 	If you select Enabled , removing any internal storage device when your computer is in sleep mode will be detected. If you remove the internal storage device while the computer is in sleep mode, the computer will shut down when you wake it up, and any unsaved data will be lost.
Anti-Theft	Computrace Module Activation	<ul style="list-style-type: none"> • Disabled • Enabled • Permanently Disabled 	Enable or disable the UEFI BIOS interface to activate the computrace module. Computrace is an optional monitoring service from Absolute Software. Note: If you set the computrace module activation to Permanently Disabled , you will be unable to enable this setting again.
Secure Boot	Secure Boot	<ul style="list-style-type: none"> • Disabled • Enabled 	Enable or disable the UEFI Secure Boot feature. Select Enable to prevent unauthorized operating systems from running at boot time. Select Disabled to allow any operating systems to run at boot time.
	Platform Mode	<ul style="list-style-type: none"> • Setup Mode • User Mode 	Specify the system operating mode.
	Secure Boot Mode	<ul style="list-style-type: none"> • Standard Mode • Custom Mode 	Specify the Secure Boot mode.
	Reset to Setup Mode		This option is used to clear the current platform key and put the system into Setup Mode . You can install your own platform key and customize the Secure Boot signature databases in Setup Mode . Secure Boot mode will be set to Custom Mode .

Table 2. Security menu items (continued)

Menu item	Submenu item	Value	Comments
	Restore Factory Keys		This option is used to restore all keys and certificates in Secure Boot databases to factory defaults. Any customized Secure Boot settings will be erased, and the default platform key will be re-established along with the original signature databases including certificate for Windows 10 operating system.
	Clear All Secure Boot Keys		This option is used to clear all keys and certificates in Secure Boot databases. You can install your own keys and certificates after selecting this option.
Intel (R) SGX	Intel (R) SGX Control	<ul style="list-style-type: none"> • Disabled • Enabled • Software Controlled 	<p>This option enables or disables Intel Software Guard Extensions (SGX) function.</p> <p>Disabled: Disables SGX.</p> <p>Enabled: Enables SGX.</p> <p>Software Controlled: Software Guard Extensions will be controlled by the operating system.</p>
	Owner EPOCH Change	Enter	Change Owner EPOCH to a random value. This option is used to clear user data of SGX.
Device Guard	Device Guard	<ul style="list-style-type: none"> • Disabled • Enabled 	<p>This option is used to support Microsoft Device Guard.</p> <p>When this option is enabled, Intel Virtualization Technology, Intel VT-d Feature, Secure Boot, and OS Optimized Defaults are automatically enabled. Boot order is not selectable, and the computer only starts from the internal storage drive.</p> <p>To complete the configuration of Device Guard, you have to set a supervisor password.</p> <p>When this option is disabled, the setup options are configurable and you can choose any boot options to start the computer.</p>

Startup menu

To change the startup settings of your computer, select the **Startup** tab from the ThinkPad Setup menu.

The following table lists the **Startup** menu items. Default values are in **boldface**. The menu items might change without notice. Depending on the model, the default value might vary.

Note: Some items are displayed on the menu only if the computer supports the corresponding features.

Table 3. Startup menu items

Menu item	Value	Comments
Boot		Select the boot device when you press the power button to turn on the computer.
Network Boot		Select the boot device when the system wakes from LAN. If Wake On LAN is enabled, the network administrator can turn on all of the computers in a LAN remotely by use of network management software.
UEFI/Legacy Boot	<ul style="list-style-type: none"> • Both <ul style="list-style-type: none"> – UEFI/Legacy Boot Priority <ul style="list-style-type: none"> – UEFI First – Legacy First • UEFI Only • Legacy Only • CSM Support (for UEFI Only) • Yes • No 	<p>Select system boot capability.</p> <ul style="list-style-type: none"> • Both: Select priority of boot options between UEFI and Legacy. • UEFI Only: The system will boot from the UEFI enabled operating system. • Legacy Only: The system will boot from any operating system other than the UEFI enabled one. <p>Note: If you select UEFI Only, the system cannot boot from the bootable devices that do not have the UEFI enabled operating system.</p> <p>Compatibility Support Module (CSM) is required for booting the legacy operating system. If you select UEFI Only, CSM Support is selectable. For Both or Legacy Only mode, CSM Support is not selectable.</p>
Boot Mode	<ul style="list-style-type: none"> • Quick • Diagnostics 	<p>Screen during the POST:</p> <ul style="list-style-type: none"> • Quick: The logo screen is displayed. • Diagnostics: Text messages are displayed. <p>Note: You also can enter Diagnostic mode by pressing Esc during the POST.</p>
Option Key Display	<ul style="list-style-type: none"> • Disabled • Enabled 	If you select Disabled , the “To interrupt normal startup, press Enter.” message is not displayed during the POST.
Boot Device List F12 Option	<ul style="list-style-type: none"> • Disabled • Enabled 	If you select Enabled , the F12 key is recognized and the Boot Menu window is displayed.
Boot Order Lock	<ul style="list-style-type: none"> • Disabled • Enabled 	If you select Enabled , the boot priority order is locked for your future use.

Restart menu

To exit the ThinkPad Setup program and restart the computer, select **Restart** from the ThinkPad Setup menu.

The following submenu items are displayed:

- **Exit Saving Changes:** Save the changes and restart the computer.
- **Exit Discarding Changes:** Discard the changes and restart the computer.
- **Load Setup Defaults:** Restore to the factory default settings.

Note: Enable **OS Optimized Defaults** to meet the Windows 10 certification requirements. When you change this setting, some other settings are changed automatically, such as **CSM Support**, **UEFI/Legacy Boot**, **Secure Boot**, **Secure RollBack Prevention**, **Intel Virtualization Technology**, and **Intel VT-d Feature**.

- **Discard Changes:** Discard the changes.
- **Save Changes:** Save the changes.

Using system management

This topic is primarily intended for the network administrators.

Your computer is designed for manageability, so that you can redirect more resources to better meet your business objectives.

This manageability, known as total cost of ownership (TCO), enables you to remotely operate client computers in the same way as you operate your own computer, such as turning on a client computer, formatting a storage drive, and installing a program.

Once the computer is configured and operational, you can manage it by using the software and the manageability features that are already integrated into the client computer and the network.

Desktop Management Interface

The UEFI BIOS of your computer supports an interface called System Management BIOS (SMBIOS) Reference Specification, version 2.8 or later. SMBIOS provides information about the hardware components of your computer. It is the responsibility of the UEFI BIOS to provide information about itself and the devices on the system board. This specification documents the standards for getting access to this BIOS information.

Preboot eXecution Environment

The Preboot eXecution Environment (PXE) technology makes the computer more manageable by enabling the computer to start from a server. Your computer supports the personal computer functions that PXE requires. For example, with the appropriate LAN card, your computer can be started from the PXE server.

Note: The Remote Initial Program Load (RIPL or RPL) function cannot be used with your computer.

Wake on LAN

The network administrator can turn on a computer from a management console by using the Wake on LAN feature.

When the Wake on LAN feature is enabled, many operations, such as data transfer, software updates, and flash updates of the UEFI BIOS, can be done remotely without remote attendance. The updating process can perform after normal working hours and on weekends, so that the users are not interrupted during work, and the LAN traffic is kept to a minimum. It saves time and increases productivity.

If the computer is turned on through Wake on LAN, the computer starts follow the **Network Boot** sequence.

Asset ID EEPROM

The Asset ID EEPROM contains information about the computer configuration and the serial numbers of the key components. It also includes a number of blank fields where you can record information about the end users in your network.

To enable a network administrator to remotely control your computer, set the following system-management features in the ThinkPad Setup program:

- Wake on LAN
- Network Boot sequence

Note: If a supervisor password has been set, you are required to enter the supervisor password when you start the ThinkPad Setup program.

Enabling or disabling the Wake on LAN feature

When the Wake on LAN feature is enabled and the computer is connected to a LAN, the network administrator can start the computer remotely from a management console, using a remote network-management program.

To enable or disable the Wake on LAN feature, do the following:

1. Restart the computer. When the logo screen is displayed, press F1 to start the ThinkPad Setup program.
2. Select **Config** → **Network**. The **Network** submenu is displayed.
3. Select a corresponding option for the Wake on LAN feature.
4. Press F10 to save the settings and exit.

Defining a Network Boot sequence

When the computer wakes on LAN, the computer boots from the device as specified on the **Network Boot** menu, and then follow the boot order list on the **Boot** menu.

To define a Network Boot sequence, do the following:

1. Restart the computer. When the logo screen is displayed, press F1 to start the ThinkPad Setup program.
2. Select **Startup** → **Network Boot**. The boot device list is displayed.
3. Select a boot device to make it as the top boot priority.
4. Press F10 to save the settings and exit.

You can press F9 to restore to the factory default settings.

Chapter 7. Configuring RAID

This chapter provides information about storage drive requirements for Redundant Array of Independent Disks (RAID) levels, and instructions on how to configure RAID for your computer.

An Introduction to RAID

RAID is a technology that provides increased storage functions and reliability through redundancy.

When a group of independent physical storage drives is set up to use RAID technology, they are in a RAID array. This array distributes data across multiple storage drives, but the array appears to the host computer as one single storage unit. Creating and using RAID arrays provides high performance, such as the expedited I/O performance, because several drives can be accessed simultaneously.

RAID drive groups configured according to certain RAID levels also improve data storage reliability and fault tolerance compared with single-drive storage systems. Data loss resulting from a drive failure can be prevented by reconstructing missing data from the remaining drives.

Note: For RAID 0, the missing data resulting from a drive failure cannot be reconstructed.

Storage drive requirements for RAID levels

Your computer supports the following internal storage drives:

- 2.5-inch form factor, 7-mm (0.28-inch) height hard disk drive
- M.2 Serial Advanced Technology Attachment (SATA) solid-state drive (available on some models)
- M.2 Non-Volatile Memory Express (NVMe) solid-state drive (available on some models)

Note: Ensure that your computer has two identical storage drives installed (two hard disk drives, M.2 SATA solid-state drives, or M.2 NVMe solid-state drives with the same capacity) for supported RAID levels. If only one drive is installed, or two different types of drives are installed, the following information does not apply.

Your computer supports the following RAID levels:

- RAID 0: striped disk array
 - Consists of two identical storage drives
 - Supported strip size: 4 KB, 8 KB, 16 KB, 32 KB, 64 KB, or 128 KB
 - Better performance without fault tolerance
 - Higher risk of data loss resulting from a member drive failure compared with non-RAID configuration
- RAID 1: mirrored disk array
 - Consists of two identical storage drives
 - Improved reading performance and 100% redundancy

Configuring RAID with the Intel RST configuration utility

This topic provides the following instructions to help you configure RAID with the Intel RST configuration utility:

- How to enter the Intel RST configuration utility
- How to create RAID volumes

- How to delete RAID volumes
- How to reset storage drives to non-RAID
- How to rebuild RAID 1 volumes

Entering the Intel RST configuration utility

This topic provides instructions on how to enter the Intel RST configuration utility.

Enabling RAID from ThinkPad Setup

If RAID is disabled, you must enable it manually before entering the Intel RST configuration utility.

To enable RAID, do the following:

1. Restart the computer. When the logo screen is displayed, press F1 to start the ThinkPad Setup program.
2. Select **Config** → **RAID** → **RAID Mode Option** → **Enabled**.
3. Select **RAID Storage**, press Enter, and then select either **SATA HDD** or **M.2 SSD** depending on which type of internal storage drives are installed.
4. Press F10 to save changes and exit.

Entering the Intel RST configuration utility

To enter the Intel RST configuration utility, do the following:

1. Restart the computer. When the logo screen is displayed, press F1 to start the ThinkPad Setup program.
2. Select **Config** → **RAID** → **Intel (R) Rapid Storage Technology** and then press Enter to open the “Intel (R) Rapid Storage Technology” window.

The following options are displayed after you enter the Intel RST configuration utility:

- **Create RAID Volume:** This option is used to create a RAID volume. If no internal storage drives can be used, this option is not available.
- **RAID Volumes:** This option is used to confirm the information of the created RAID volumes.
- **Non-RAID Physical Disks:** This option is used to confirm the information of all non-RAID drives.

Press the up and down arrow keys to select an option. Press Enter to enter the menu for the selected option. Press Esc to exit the Intel RST configuration utility.

Creating RAID volumes

This topic provides instructions on how to use the Intel RST configuration utility to create RAID volumes.

Attention: All the existing data stored on the selected drives will be erased while the RAID volume is being created.

To create a RAID volume, do the following:

1. Enter the Intel RST configuration utility. See “Entering the Intel RST configuration utility” on page 84.
2. Press the up and down arrow keys to select **Create RAID Volume**, and then press Enter to open the CREATE RAID VOLUME window.
3. Press the up and down arrow keys to select and configure the options one by one.
 - a. **Name:** You can use the default name or type a preferred name for the RAID volume.
 - b. **RAID Level:** You can press Enter to change the RAID to one of the following:
 - **RAID0 (Stripe)**
 - **RAID1 (Mirror)**

- c. **Select Disks:** Press the up and down arrow keys to select a drive, and then press Spacebar or Enter to add it into a group. An **X** mark is displayed next to the selected drive.

Note: The drive that cannot be used to create a RAID volume is not selectable.

- d. **Strip Size:** Press the up and down arrow keys to select a strip size, and then press Enter to complete the configuration.

Note: This option is only available for RAID 0.

- e. **Capacity:** Customize the capacity of the RAID volume. The default RAID volume is the largest value.
- f. **Create Volume:** Press Enter to finish configurations of the preceding options and create a volume.

Note: The **Create Volume** option might not be selectable for some reasons, for example, if different types of drives are selected, the option is not selectable. If it is not selectable, see the message displayed under **Create Volume** for reference.

After the RAID volume is created, the “Intel (R) Rapid Storage Technology” window is displayed, and the created volume is displayed under **RAID Volumes**.

4. Press F10 to save changes and exit.

Deleting RAID volumes

This topic provides instructions on how to use the Intel RST configuration utility to delete RAID volumes.

Attention: All the existing data stored on the selected drives will be erased after you delete RAID volumes.

To delete a RAID volume, do the following:

1. Enter the Intel RST configuration utility. See “Entering the Intel RST configuration utility” on page 84.
2. Press the up and down arrow keys to select the volume that you want to delete under **RAID Volumes**. Press Enter to open the RAID VOLUME INFO window.
3. Select **Delete** and press Enter to delete it from the **RAID Volumes** list.
4. When prompted, select **Yes** to confirm the deletion of the selected RAID volume.

After you delete the RAID volume, the “Intel (R) Rapid Storage Technology” window is displayed. Member drives of the deleted volume are displayed under **Non-RAID Physical Disks**.

5. Press F10 to save changes and exit.

Resetting storage drives to non-RAID

This topic provides instructions on how to use the Intel RST configuration utility to reset storage drives to non-RAID.

Attention: All the existing data stored on the selected drive will be erased after you reset it to non-RAID.

To reset a storage drive to non-RAID, do the following:

1. Enter the Intel RST configuration utility. See “Entering the Intel RST configuration utility” on page 84.
2. Press the up and down arrow keys to select the volume that you want to reset under **RAID Volumes**. Press Enter to open the RAID VOLUME INFO window.
3. Press the up and down arrow keys to select the drive that you want to reset under **RAID Member Disks**. Press Enter to open the PHYSICAL DISK INFO window.
4. Select **Reset to Non-RAID** and press Enter. When prompted, press **Yes** to confirm the reset action.

After the reset process finishes, the “Intel (R) Rapid Storage Technology” window is displayed. The reset drive is listed under **Non-RAID Physical Disks**, and the volume of the reset drive is still listed under **RAID Volumes**, but the status is changed from **Normal** to **Failed** or **Degraded**.

5. Press F10 to save changes and exit.

Rebuilding RAID 1 volumes

If the status of a RAID 1 volume is **Failed** or **Degraded**, you can rebuild it through the Intel RST configuration utility. To rebuild a RAID 1 volume, ensure that at least one member drive of the RAID 1 volume works correctly. Replace the failed drive with a new one that has the same capacity before you rebuild a RAID 1 volume.

To rebuild a RAID 1 volume, do the following:

1. Enter the Intel RST configuration utility. See “Entering the Intel RST configuration utility” on page 84.
2. Press the up and down arrow keys to select the volume that you want to rebuild under **RAID Volumes**. Press Enter to open the RAID VOLUME INFO window.
3. Select **Rebuild** and press Enter to open the Rebuild Volume window.
4. Select the drive that you want to rebuild and press Enter to initiate the rebuild process.
After you initiate the rebuild process, the “Intel (R) Rapid Storage Technology” window is displayed. The RAID 1 volume under rebuilding is displayed under **RAID Volumes** with a **Rebuilding** mark.
5. Wait a few minutes. When the rebuild process finishes successfully, the **Rebuilding** mark is changed to the **Normal** mark.
6. Press F10 to save changes and exit.

Chapter 8. Troubleshooting computer problems

This chapter provides information about what to do if you experience a problem with your computer.

General tips for preventing problems

This topic provides the following tips to help you prevent computing problems:

- Empty your recycle bin on a regular basis.
- Use a disk defragment tool regularly on your storage drive to improve data seek and read times.
- To free up disk space, uninstall unused programs. You also might want to look for program duplication or overlapping versions.
- Clean out your Inbox, Sent, and Trash folders from your e-mail client program.
- Back up your data at least once a week. If critical data is present, it is a good idea to back up the data daily. Lenovo has many backup options available for your computer.
- Schedule system restore operations to take a system snapshot periodically. For information about system restore, see Chapter 9 “Recovery information” on page 105.
- Go to <https://support.lenovo.com> to download and install updates for the device drivers and UEFI BIOS when needed.
- Keep up to date for device drivers on other non-Lenovo hardware. Before updating device drivers, read the device driver information release notes for compatibility or known issues.
- Keep a log book. Entries might include major hardware or software changes, driver updates, minor issues you have experienced, and how you resolved the minor issues.
- If you ever need to run a recovery on your computer to return the preinstalled contents onto the machine, the following tips might help along the way:
 1. Remove all external devices such as the printer and keyboard.
 2. Ensure that your battery is charged and your computer has the ac power connected.
 3. Access ThinkPad Setup and load the default settings.
 4. Restart the computer and start the recovery operation.
 5. If your computer uses discs as the recovery media, do not remove the disc from the drive until prompted to do so.

Diagnosing problems

Many computer problems can be solved without outside assistance. If you experience a problem with your computer, the first place to start is the troubleshooting information in your computer documentation. If you suspect a software problem, see the documentation, including readme files and help information systems, that come with the operating system or program. ThinkPad notebook computers come with a set of diagnostic programs that you can use to help you identify hardware problems.

Diagnosing problems with Lenovo Solution Center on the Windows 7 operating system

Notes:

- If you are using another Windows operating system rather than the Windows 7, you can find the latest information about diagnostics for your computer at:
<https://www.lenovo.com/diags>
- If you are unable to isolate and repair the problem yourself after running Lenovo Solution Center, save and print the log files created by the program. You need the log files when you speak to a Lenovo technical support representative.

Lenovo Solution Center enables you to troubleshoot and resolve computer problems. It combines diagnostic tests, system information collection, security status, and support information, along with hints and tips for optimal system performance.

When you are setting up your computer, the Lenovo Solution Center program prompts you to create recovery media. You can use the recovery media to restore the storage drive to the factory default settings. For more information, see “Creating and using recovery media” on page 105.

To run Lenovo Solution Center, see “Accessing Lenovo programs” on page 14.

For additional information, see the Lenovo Solution Center help system.

Diagnosing problems with Lenovo Vantage on the Windows 10 operating system

Note: If you are unable to isolate and repair the problem yourself after running Lenovo Vantage, save and print the log files created by the program. You need the log files when you speak to a Lenovo technical support representative.

Lenovo Vantage supports the hardware scan function. It combines diagnostic tests, system information collection, security status, and support information, along with hints and tips for optimal system performance. To run Lenovo Vantage, see “Accessing Lenovo programs” on page 14.

The troubleshooting information or the diagnostic programs might tell you that you need additional or updated device drivers or other software. You can get the latest technical information and download device drivers and updates from the Lenovo Support Web site at:

<https://support.lenovo.com>

For additional information, see the Lenovo Vantage help system.

Troubleshooting

If your computer has an error, it typically displays a message or an error code, or makes a beep when you turn it on. When you experience a problem, see the corresponding symptom and solution in this topic to try to solve the problem by yourself.

Computer stops responding

Print these instructions now and keep it with your computer for reference later.

If your computer is unresponsive (you cannot use the ThinkPad pointing device or the keyboard), do the following:

1. Press and hold the power button until the computer turns off. If you cannot turn off the computer by pressing the power button, remove the ac power adapter and the removable battery. After the computer

is turned off, reconnect the ac power adapter and reinstall the removable battery, and then restart the computer by pressing the power button. If the computer does not turn on, continue with step 2.

2. While the computer is turned off, remove all power sources from the computer (removable battery and the ac power adapter). Plug in the ac power adapter while keeping the removable battery out of the computer. If the computer does not turn back on, continue with step 3.

Note: Once the computer starts up and enters the Windows environment, use the proper shutdown procedure to turn off the computer. Once the computer is off, reattach the removable battery and restart the computer. If the computer does not start with the removable battery reattached, remove the removable battery and again start with step 2. If the computer starts with ac power but does not start when the removable battery is attached, call the Customer Support Center for support.

3. While the computer is off, remove all sources of power (removable battery and the ac power adapter). Remove all external devices that are attached to your computer (keyboard, mouse, printer, scanner, and so on). Repeat step 2. If step 2 is unsuccessful, continue with step 4.

Note: The following steps involve removing static sensitive components from your computer. Make sure that you are properly grounded and remove all sources of power attached to the computer. If you are uncomfortable or unsure about removing components, call the Customer Support Center for assistance.

4. While the computer is off, remove all sources of power and external hardware. Remove any non-original memory module added to your computer. After removing the extra memory module and reinstalling the original memory module, repeat step 2. If the computer still does not turn on, consult the user manual for other customer-replaceable components that are attached to your computer.

If the computer still does not start up, call the Customer Support Center and a Customer Support Specialist will assist you.

Spills on the keyboard

With a mobile computer, there are increased chances of spilling liquids on the keyboard. Because most liquids conduct electricity, liquid spilled on the keyboard could create numerous short circuits, potentially causing irreparable damage to your computer.

If you spill something on your computer:

Attention: Be sure that no liquid creates a short circuit between you and the ac power adapter (if in use). Although you might lose some data or work by turning off the computer immediately, leaving the computer on might make your computer unusable.

1. Carefully unplug the ac power adapter immediately.
2. Turn off the computer immediately. If the computer does not turn off, remove the removable battery. The more quickly you stop the current from passing through the computer the more likely you will reduce damage from short circuits.
3. Wait until you are certain that all the liquid is dry before turning on your computer.

Note: If you want to replace your keyboard, you can purchase a new one.

Error messages

- **Message:** 0177: Bad SVP data, stop POST task.

Solution: Checksum of the supervisor password in the EEPROM is not correct. The system board should be replaced. Have the computer serviced.

- **Message:** 0183: Bad CRC of Security Settings in EFI Variable. Enter ThinkPad Setup.

Solution: Checksum of the Security settings in the EFI Variable is not correct. Enter ThinkPad Setup to check security settings, press F10, and then press Enter to restart the system. If you still have a problem, have the computer serviced.

- **Message:** 0187: EAIA data access error

Solution: The access to EEPROM is failed. Have the computer serviced.

- **Message:** 0188: Invalid RFID Serialization Information Area

Solution: The EEPROM checksum is not correct (block # 0 and 1). The system board should be replaced, and the box serial number must be reinstalled. Have the computer serviced.

- **Message:** 0189: Invalid RFID configuration information area

Solution: The EEPROM checksum is not correct (block # 4 and 5). The system board should be replaced, and the universally unique identifier (UUID) must be reinstalled. Have the computer serviced.

- **Message:** 0190: Critical low-battery error

Solution: The computer turned off because the battery power is low. Connect the ac power adapter to the computer and charge the batteries.

- **Message:** 0191: System Security - Invalid remote change requested

Solution: The system configuration change has failed. Confirm the operation and try again. To clear the error, enter ThinkPad Setup.

- **Message:** 0199: System Security - Security password retry count exceeded.

Solution: This message is displayed if you enter a wrong supervisor password more than three times. Confirm the supervisor password and try again. To clear the error, enter ThinkPad Setup.

- **Message:** 0270: Real Time Clock Error.

Solution: System Real Time Clock is not functional. Have the computer serviced.

- **Message:** 0271: Check Date and Time settings.

Solution: The date or the time is not set in the computer. Enter ThinkPad Setup and set the date and time.

- **Message:** 1802: Unauthorized network card is plugged in - Power off and remove the network card.

Solution: The wireless network card is not supported on this computer. Remove it.

- **Message:** 1820: More than one external fingerprint readers are attached.

Solution: Turn off and remove all but the reader that you set up within your main operating system.

- **Message:** 2100: Detection error on HDD0 (Main HDD)

Solution: The hard disk drive is not working. Have the hard disk drive serviced.

- **Message:** 2101: Detection error on SSD1 (M.2)

Solution: The M.2 solid-state drive is not working. Have the M.2 solid-state drive serviced.

- **Message:** 2102: Detection error on SSD2 (M.2)

Solution: The M.2 solid-state drive is not working. Have the M.2 solid-state drive serviced.

- **Message:** 2110: Read error on HDD0 (Main HDD)

Solution: The hard disk drive is not working. Have the hard disk drive serviced.

- **Message:** 2111: Read error on SSD1 (M.2)

Solution: The M.2 solid-state drive is not working. Have the M.2 solid-state drive serviced.

- **Message:** 2112: Read error on SSD2 (M.2)

Solution: The M.2 solid-state drive is not working. Have the M.2 solid-state drive serviced.

- **Message:** 2200: Machine Type and Serial Number are invalid.

Solution: Machine Type and Serial Number are invalid. Have the computer serviced.

- **Message:** 2201: Machine UUID is invalid.
Solution: Machine UUID is invalid. Have the computer serviced.
- **Message:** Fan error
Solution: Cooling fan has failed. Shut down the computer immediately and have the computer serviced.
- **Message:** Thermal sensing error
Solution: The thermal sensor has a problem. Shut down the computer immediately and have the computer serviced.
- **Message:** Bottom Cover Tamper Detection Error
Solution: The Bottom Cover Tamper Switch is not working. Have the computer serviced.
- **Message:** Error: The non-volatile system UEFI variable storage is nearly full.

Note: This error indicates that the operating system or programs cannot create, modify, or delete data in the non-volatile system UEFI variable storage due to insufficient storage space after POST.

The non-volatile system UEFI variable storage is used by the UEFI BIOS and by the operating system or programs. This error occurs when the operating system or programs store large amounts of data in the variable storage. All data needed for POST, such as BIOS setup settings, chipset, or platform configuration data, are stored in a separate UEFI variable storage.

Solution: Press F1 after the error message is displayed to enter ThinkPad Setup. A dialog asks the user for confirmation to clean up the storage. If the user selects “Yes”, all data that were created by the operating system or programs will be deleted except global variables defined by the Unified Extensible Firmware Interface Specification. If the user selects “No”, all data will be kept, but the operating system or programs will not be able to create, modify, or delete data in the storage.

If this error happens at a service center, Lenovo authorized service personnel will clean up the non-volatile system UEFI variable storage using the preceding solution.

Beep errors

Lenovo SmartBeep technology enables you to decode beep errors with your smartphone when a black screen occurs with beeps from your computer. To decode the beep error with Lenovo SmartBeep technology, do the following:

1. Go to <https://support.lenovo.com/smartbeep> or scan the following QR Code.



2. Download the proper diagnostic app and install it on your smartphone.
3. Run the diagnostic app and place the smartphone near the computer.
4. Press the Fn key on your computer to emit the beep again. The diagnostic app decodes the beep error and shows possible solutions on the smartphone.

The following section describes some beep errors and the corresponding solutions.

Note: Do not attempt to service a product yourself unless instructed to do so by the Customer Support Center or product documentation. Only use a Lenovo-authorized service provider to repair your product.

Error codes	Solutions
0001: Reset error (platform reset not de-asserted)	<ol style="list-style-type: none"> 1. Remove all power resources (the ac power adapter and removable battery). 2. Reset the computer by doing one of the following: <ul style="list-style-type: none"> • For models with the emergency-reset hole, insert a straightened paper clip into the emergency-reset hole. Wait for one minute. Then reconnect all power resources and restart the computer. • For models without the emergency-reset hole, press and hold the power button for about seven seconds. Then, reconnect to all power resources and restart the computer. <p>If the above solution does not work, replace the system board (service provider only).</p>
0002: Internal bus error	Replace the system board (service provider only).
0281: General embedded controller error	Replace the system board (service provider only).
0282: Memory module error	<p>Reinstall or replace the memory module.</p> <p>If the above solution does not work, replace the system board (service provider only).</p>
0283: PCI resource error	<p>Remove PCIe devices (the M.2 card, PCIe card, and so on) (service provider only).</p> <p>If the above solution does not work, replace the system board (service provider only).</p>
0284: TCG-compliant functionality-related error (might be the BIOS code validation failure)	Replace the system board (service provider only).
0285: TCG-compliant functionality-related error (might be the TPM initialization failure)	Replace the system board (service provider only).
0286: Integrated graphics error	Replace the system board (service provider only).
0287: Discrete graphics error	<p>Reinstall or replace the discrete graphics card (service provider only).</p> <p>If the above solution does not work, replace the system board (service provider only).</p>
0288: Computer display error	<p>Reconnect the display cable on both the system board side and the computer display side (service provider only).</p> <p>If the above solution does not work, replace the system board (service provider only).</p>

Memory module problems

Print these instructions now and keep the instructions with your computer for reference later.

If your memory module is not operating properly, check the following items:

1. Verify that the memory module is installed and seated correctly in your computer.

It might be necessary to remove all added memory modules to test the computer with only the factory-installed memory modules, and then reinstall the memory module one at a time to ensure a proper connection.

2. Check for error messages during startup.

Follow the appropriate corrective actions for power-on self-test (POST) error messages.

3. Verify that the latest UEFI BIOS for your model has been installed.
4. Verify the proper memory configuration and compatibility including the maximum memory size and the memory speed.
5. Run diagnostic programs. See “Diagnosing problems” on page 87.

Wireless-LAN problem

Problem: I cannot connect to the network using the built-in wireless network card.

Solution: Ensure that:

- The Airplane mode is off.
- Your wireless-LAN driver is the latest version.
- Your computer is within the range of a wireless access point.
- The wireless radio is enabled.

Note: If you are using the Windows 7 operating system, click **Show hidden icons** on the taskbar. The Access Connections icon is displayed. For more information about the icon, see the Access Connections help information system.

For the Windows 7 operating system, check the network name (SSID) and your encryption information. Use the Access Connections program to verify this case-sensitive information.

Wireless-WAN problem

Problem: A message is displayed indicating that an unauthorized WAN card is installed.

Solution: The WAN card is not supported on this computer. Remove the WAN card. For more information, see “Replacing the wireless-WAN card” on page 114.

Note: Some models do not have a wireless-WAN card.

Bluetooth problem

Note: Check your connection anytime and ensure that no other Bluetooth-enabled device is searching for the device to which you want to connect. Simultaneous searching is not allowed in the Bluetooth connection.

- **Problem:** Sound does not come from the Bluetooth headset/headphones but comes from the local speaker even though the Bluetooth headset/headphones is connected using a Headset profile or AV profile.

Solution: Do the following:

1. Exit the program that uses the sound device (for example, Windows Media Player).
2. Go to Control Panel, and ensure that you view Control Panel by Category.
3. Click **Hardware and Sound** → **Sound** → **Playback**.
4. If you are using a Headset profile, select **Bluetooth Hands-free Audio** and click **Set Default**. If you are using an AV profile, select **Stereo Audio** and click **Set Default**.

5. Click **OK** to close the Sound window.

- **Problem:** PIM items sent from the Windows 7 operating systems cannot be received correctly into the address book of any other Bluetooth-enabled device.

Solution: The Windows 7 operating system sends PIM items in XML format, but most Bluetooth-enabled devices handle PIM items in vCard format. If another Bluetooth-enabled device can receive a file through Bluetooth, a PIM item sent from the Windows 7 operating system might be saved as a file with the extension .contact.

ThinkPad pointing device problems

- **Problem:** The pointer drifts when the computer is turned on or after it resumes normal operation.

Solution: The pointer might drift when you are not using the TrackPoint pointing device during normal operation. This is a normal characteristic of the TrackPoint pointing device and is not a defect. Pointer drifting might occur for several seconds under the following conditions:

- When the computer is turned on
- When the computer resumes normal operation
- When the TrackPoint pointing device is kept pressed for a long time
- When the temperature changes

- **Problem:** The TrackPoint pointing device or trackpad does not work.

Solution: Ensure that the TrackPoint pointing device or trackpad is enabled in the Mouse Properties window. For more information, see “Customizing the ThinkPad pointing device” on page 25.

Keyboard problems

- **Problem:** All or some keys on the keyboard do not work.

Solution: If an external numeric keypad is connected:

1. Turn off the computer.
2. Remove the external numeric keypad.
3. Turn on the computer and try using the keyboard again.

If the keyboard problem is resolved, carefully reconnect the external numeric keypad.

If the problem persists, ensure that the correct device driver is installed by doing the following:

1. Go to Control Panel, and then change the view of Control Panel from Category to Large icons or Small icons.
2. Click **Keyboard**.
3. Click the **Hardware** tab. In the **Device Properties** section, ensure that you see this message: Device status: This device is working properly.

If keys on the keyboard still do not work, have the computer serviced.

- **Problem:** All or some keys on the external numeric keypad do not work.

Solution: Ensure that the external numeric keypad is correctly connected to the computer.

- **Problem:** The keys on the top row of the numeric keypad might not function the same as the icon printed on each key.

Solution: Do the following:

1. Go to Control Panel, and then change the view of Control Panel from Category to Large icons or Small icons.
2. Click **Keyboard**. In the Keyboard Properties window, click the **Fn and function keys** tab.

Note: If the **Fn and function keys** tab is not displayed, connect your computer to the Internet. Then download and install the ThinkPad Hotkey Features program from the Lenovo Support Web site. For more information, see “Installing device drivers” on page 63.

3. In the **How to use Fn key combinations** section, select your preferred option.
4. If you select **Fn sticky method**, press Fn to reset the Fn sticky status.
5. Try to press keys on the top row of the numeric keypad again to check if the problem is resolved.

Computer screen problems

- **Problem:** My screen keeps blanking when I do not want it to.

Solution:

- If your computer is preinstalled with the Windows 7 operating system, you can disable any system timers, such as the LCD turn-off timer or the blank timer by doing the following:
 1. Start the Power Manager program. See “Accessing Lenovo programs” on page 14.
 2. Click the **Power plan** tab, and then select **Maximum Performance** from the predefined power plans.
- If your computer is preinstalled with the Windows 10 operating system, do the following:
 1. Go to Control Panel, and ensure that you view Control Panel by Category.
 2. Click **Hardware and Sound → Power Options**.
 3. Show the additional plans, and then select **High performance**.

- **Problem:** When I turn on the computer, nothing is displayed on the screen and the computer does not beep while starting up.

Note: If you are not sure whether you heard any beeps, turn off the computer by pressing and holding the power button for four seconds or more. Then turn on the computer and listen again.

Solution: Ensure that:

- The battery is installed correctly.
- The ac power adapter is connected to the computer and the power cord is plugged into a working electrical outlet.
- The computer is turned on. (Press the power button again for confirmation.)
- The brightness level of the screen is appropriately set.

If a power-on password is set, press any key to display the prompt for the power-on password and then type the correct password and press Enter.

If these items are correctly set, and the screen remains blank, have the computer serviced.

- **Problem:** When I turn on the computer, only a white cursor is displayed on a blank screen.

Solution: If you have modified a partition on your hard disk drive by using partition software, information about that partition, or the master boot record might have been destroyed.

Do the following to try to solve the problem:

1. Turn off the computer, and then turn it on again.
2. If you still see only the cursor on the screen, do the following:
 - If you have used partition software, examine the partition on the hard disk drive by using the software, and recover the partition if required.
 - Use the recovery solutions to restore the system to the factory default state. For more information, see Chapter 9 “Recovery information” on page 105.

If the problem persists, have the computer serviced.



- **Problem:** The screen goes blank while the computer is on.

Solution: Your screen saver or power management might have been enabled. Do one of the following:

- Touch the TrackPoint pointing device or the trackpad, or press a key to exit the screen saver.
- Press the power button to resume the computer from sleep or hibernation mode.

- **Problem:** The screen is blank.

Solution: Do the following:

1. Press the display-mode switching key  to bring up the image.
2. If you are using the ac power adapter, or using the battery and the battery gauge shows that the battery is not depleted, press the brightness-up key  to make the screen brighter.
3. If your computer is in sleep mode, press Fn to resume the computer from sleep mode.
4. If the problem persists, follow the solution for the following problem.

- **Problem:** The screen is unreadable or distorted.

Solution: Ensure that:

- The display device driver is installed correctly.
- The screen resolution and color quality are correctly set.
- The monitor type is correct.

To check these settings, do the following:

1. Right-click on the desktop, and do the following:
 - **For Windows 7:** Click **Screen resolution**.
 - **For Windows 10:** Click **Display settings** → **Display**.

Note: If your computer cannot detect the external monitor, click **Detect** in the Display window.

2. Select the external monitor and set **Resolution**.

3. Do the following:

- **For Windows 7:** Click **Advanced Settings**.
- **For Windows 10:** Click **Display adapter properties**.

4. Click the **Monitor** tab. Check the monitor information to make sure that the monitor type is correct. If it is, click **OK** to close the window; otherwise proceed with the following steps.

5. If more than two monitor types are displayed, select **Generic PnP Monitor** or **Generic Non-PnP Monitor**.

6. Click **Properties**. If you are prompted for an administrator password or confirmation, type the password or provide confirmation.

7. Click the **Driver** tab.

8. Click **Update Driver**.

9. Click **Browse my computer for driver software**, and then click **Let me pick from a list of device drivers on my computer** (for Windows 7) or click **Let me pick from a list of available drivers on my computer** (for Windows 10).

10. Clear the **Show compatible hardware** check box.

11. Select the correct manufacturer and model for the external monitor. If you cannot find your monitor on the list, stop the installation of this driver and use the driver shipped with your monitor.

12. After updating the driver, click **Close**.

- **Problem:** Incorrect characters are displayed on the screen.

Solution: Ensure that you install the operating system and program correctly. If the problem persists, have the computer serviced.

- **Problem:** I try to turn off my computer but the screen stays on and I cannot completely turn off my computer.

Solution: Press and hold the power button for four seconds or more to turn off the computer.

- **Problem:** Missing, discolored, or bright dots appear on the screen every time I turn on my computer.

Solution: This is an intrinsic characteristic of the TFT technology. Your computer display contains multiple thin-film transistors (TFTs). Only a very small number of missing, discolored, or bright dots on the screen might exist all the time.

External monitor problems

- **Problem:** The external monitor is blank.

Solution: To bring up the image, press the display-mode switching key  and select the monitor you want. If the problem persists, do the following:

1. Connect the external monitor to another computer to ensure that it works.
2. Reconnect the external monitor to your computer.
3. See the manual shipped with the external monitor to check the resolutions and refresh rates that are supported.
 - If the external monitor supports the same resolution as the computer display or a higher resolution, view output on the external monitor or on both the external monitor and the computer display.
 - If the external monitor supports a lower resolution than the computer display, view output on the external monitor only. (If you view output on both the computer display and the external monitor, the external monitor screen will be blank or distorted.)

- **Problem:** I cannot set a higher resolution than the present one on my external monitor.

Solution: Ensure that the monitor information is correct. If necessary, update the monitor driver.

- **Problem:** The screen is unreadable or distorted.

Solution: Ensure that:

- The monitor information is correct and the appropriate monitor type is selected. If necessary, update the monitor driver.
- Ensure that an appropriate refresh rate is selected by doing the following:

1. Connect the external monitor to the monitor connector, and then connect the monitor to an electrical outlet.
2. Turn on the external monitor and the computer.
3. Right-click on the desktop, and do the following:
 - **For Windows 7:** Click **Screen resolution**.
 - **For Windows 10:** Click **Display settings** → **Display**.

Note: If your computer cannot detect the external monitor, click **Detect** in the Display window.

4. Click the icon for the appropriate monitor (**Monitor-2** icon is for the external monitor).
5. Do the following:
 - **For Windows 7:** Click **Advanced Settings**.
 - **For Windows 10:** Click **Display adapter properties**.
6. Click the **Monitor** tab.
7. Select the correct screen refresh rate.

- Problem:** Wrong characters are displayed on the screen.

Solution: Ensure that you follow the correct procedure when installing the operating system and program. If they are installed and configured correctly, but the problem still persists, have the external monitor serviced.
- Problem:** The Extend desktop function does not work.

Solution: Enable the Extend desktop function. See “Using an external display” on page 35.
- Problem:** I am using the Extend desktop function, but I cannot set a higher resolution or higher refresh rate on the secondary display.

Solution: Change the resolution and the color depth to lower settings for the primary display. See “Using an external display” on page 35.
- Problem:** Display switching does not work.

Solution: If you use the Extend desktop function, disable it, and change the display output location. If a DVD movie or a video clip is playing, stop the playback, close the program, and then change the display output location.
- Problem:** The screen position on the external monitor is incorrect when that monitor is set for a high resolution.

Solution: Sometimes, when you use a high resolution such as 1600 x 1200 pixels, the image is shifted to the left or right on the screen. To correct this, first ensure that your external monitor supports the display mode (the resolution and the refresh rate) that you have set. If it does not, set a display mode that the monitor supports. If it does support the display mode you have set, go to the setup menu for the monitor itself and adjust the settings there. Usually the external monitor has buttons for access to the setup menu. For more information, see the documentation that comes with the monitor.

Audio problems

- Problem:** Wave or MIDI sound does not play properly.

Solution: Ensure that the built-in audio device is configured correctly.

 - Go to Control Panel, and ensure that you view Control Panel by Category.
 - Click **Hardware and Sound**.
 - Click **Device Manager**. If you are prompted for an administrator password or confirmation, type the password or provide confirmation.
 - Double-click **Sound, video and game controllers**.
 - Ensure that the device following **Sound, video and game controllers** is enabled and configured correctly.
- Problem:** Recordings made by using the microphone input are not loud enough.

Solution: Ensure that the Microphone Boost function is turned on and set by doing the following:

 - Go to Control Panel, and ensure that you view Control Panel by Category.
 - Click **Hardware and Sound**.
 - Click **Sound**.
 - Click the **Recording** tab in the Sound window.
 - Select **Microphone** (for Windows 7) or select **Microphone Array** (for Windows 10), and click **Properties**.
 - Click the **Levels** tab, and adjust the Microphone Boost slider as you need.
 - Click **OK**.

Note: For more information about controlling volume, see your Windows online help.

- **Problem:** I cannot move the volume slider or balance slider.
Solution: The slider might be grayed out. This means that its position is fixed by the hardware and cannot be changed.
- **Problem:** The volume sliders do not stay in place when some audio programs are used.
Solution: It is normal for the sliders to change position when certain sound programs are used. The programs are aware of the settings in the Volume Mixer window and are enabled to change the settings themselves. An example is the Windows Media Player program. Usually the program has sliders available to control the sound from within the program.
- **Problem:** The balance slider cannot completely mute one channel.
Solution: The control is designed to compensate for minor differences in balance and does not completely mute either channel.
- **Problem:** There is no volume control for MIDI sound in the Volume Mixer window.
Solution: Use the hardware volume control. This is because the built-in synthesizer software does not support the control.
- **Problem:** The sound cannot be turned off even if I set the Master volume control at minimum.
Solution: You still can hear some sound even though you have set the Master volume control at minimum. To turn off the sound completely, go to the Master volume control and select **Mute Speaker/HP**.
- **Problem:** When I connect headphones to my computer while playing sound, a speaker does not produce sound.
Solution: When the headphones are attached, the streaming is automatically redirected to it. If you want to listen to sound from the speakers again, ensure that you set those speakers as the default device. For more information, see the help information system for Realtek HD Audio Manager.
- **Problem:** Sound does not come from a headphone or a speaker, or the computer cannot record sounds.
Solution: To switch from one device to another (for example, from a speaker to a headphone, or from an external microphone to a built-in microphone), do the following:
 1. Go to Control Panel, and ensure that you view Control Panel by Category.
 2. Click **Hardware and Sound**.
 3. Click the **Sound** icon. The Sound window is displayed.
 4. Click the **Playback** tab. Select the desired device (for example, speakers) and then click **Set Default**. The speakers are set to the default device with a check mark displayed beside the speaker icon.
 5. Play any sound through a music program (for example, Windows Media Player). Ensure that sound comes from the speakers now.
 6. Then, if you would like to switch to a headset, close the music program.
 7. Click the **Playback** tab. Select **Headset Earphone** and then click **Set Default**. The headset is set to the default device with a check mark displayed beside the headset icon.
 8. Play any sound through a music program. Ensure that sound comes from the headset attached directly to the computer.

Fingerprint reader problems

- **Problem:** The surface of the reader is dirty, stained, or wet.
Solution: Gently clean the surface of the reader with a dry, soft, lint-free cloth.
- **Problem:** The reader often fails to enroll or authenticate your fingerprint.
Solution: If the surface of the reader is dirty, stained, or wet, gently clean the surface of the reader with a dry, soft, lint-free cloth.

For tips on how to maintain the fingerprint reader, refer to “Maintaining the fingerprint reader” on page 56.

Battery problems

- **Problem:** The battery cannot be fully charged in the standard charge time when the computer is powered off.

Solution: The battery might be over-discharged. Do the following:

1. Turn off the computer.
2. Ensure that the over-discharged battery is in the computer.
3. Connect the ac power adapter to the computer and let it charge.

If a quick charger is available, use it to charge the over-discharged battery.

If the battery cannot be fully charged in 24 hours, use a new battery.

- **Problem:** The computer shuts down before the battery status icon shows that the battery is empty.

Solution: Discharge and recharge the battery.

- **Problem:** The computer operates after the battery status icon shows that the battery is empty.

Solution: Discharge and recharge the battery.

- **Problem:** The operating time for a fully charged battery is short.

Solution: Discharge and recharge the battery. If your battery operating time is still short, use a new battery.

- **Problem:** The computer does not operate with a fully charged battery.

Solution: The surge protector in the battery might be active. Turn off the computer for one minute to reset the protector; then turn on the computer again.

- **Problem:** The battery cannot get charged.

Solution: You cannot charge the battery when it is too hot. If the battery feels hot, remove it from the computer and wait for a while to let it cool to room temperature. After it cools, reinstall it and recharge the battery. If it still cannot be charged, have it serviced.

ac power adapter problem

Problem: The ac power adapter is connected to the computer and the working electrical outlet, but the power adapter (power plug) icon is not displayed in the Windows notification area. The ac power indicator also does not light up.

Solution: Do the following:

1. Ensure that the connection of the ac power adapter is correct. For instructions on how to connect the ac power adapter, see “Using the ac power adapter” on page 26.
2. If the connection of the ac power adapter is correct, turn off the computer, and then disconnect the ac power adapter and remove the removable battery.
3. Reinstall the battery and reconnect the ac power adapter, and then turn on the computer.
4. If the power adapter icon still is not displayed in the Windows notification area, have the ac power adapter and your computer serviced.

Power problems

Print these instructions now and keep them with your computer for reference later.

- **Problem:** My computer is getting no power at all.

Solution: Check the following items:

1. Verify the power button. The power button is illuminated whenever the computer is on.
2. Check all power connections. Remove any power strips and surge protectors to connect the ac power adapter directly to the ac power outlet.
3. Inspect the ac power adapter. Check for any physical damage, and ensure that the power cable is firmly attached to the adapter brick and the computer.
4. Verify that the ac power source is working by attaching another device to the outlet.

- **Problem:** My computer does not run on battery power.

Solution: Check the following items:

1. Remove and reinstall the removable battery to ensure that it is properly connected.
2. If the battery runs out of power, attach the ac power adapter to recharge the battery.
3. If the battery is charged but the computer does not run, replace the battery with a new one.

- **Problem:** The system does not respond, and I cannot turn off the computer.

Solution: Turn off the computer by pressing and holding the power button for four seconds or more. If the computer still does not respond, remove the ac power adapter and the battery.

Power button problem

Problem: The system does not respond, and I cannot turn off the computer.

Solution: Turn off the computer by pressing and holding the power button for four seconds or more. If the system is still not reset, remove the ac power adapter and the battery.

Boot problems

Print these instructions now and keep them with your computer for reference later.

- **Problem:** I receive an error message before the operating system loads.

Solution: Follow the appropriate corrective actions for power-on self-test (POST) error messages.

- **Problem:** I receive an error message while the operating system is loading the desktop configuration after the POST is completed.

Solution: Find solutions by searching for the error message at the following Web sites:

- <https://support.lenovo.com>
- <https://support.microsoft.com/>

Sleep and hibernation problems

- **Problem:** The computer enters sleep mode unexpectedly.

Solution: If the microprocessor overheats, the computer automatically enters sleep mode to allow the computer to cool and to protect the microprocessor and other internal components. Check the settings for sleep mode.

- **Problem:** The computer enters sleep mode immediately after the power-on self-test.

Solution: Ensure that:

- The battery is charged.
- The operating temperature is within the acceptable range. See “Operating environment” on page 13.

If the problem persists, have the computer serviced.

- **Problem:** A critical low-battery error occurs, and the computer immediately turns off.
Solution: The battery power is getting low. Plug the ac power adapter into an electrical outlet and then into the computer. Alternatively, replace the battery with a charged one.
- **Problem:** The computer display remains blank after you press Fn to resume from sleep mode.
Solution: Check whether an external monitor was disconnected or turned off while the computer was in sleep mode. If you disconnected or turned off the external monitor, connect it or turn it on before resuming the computer from sleep mode. When resuming the computer from sleep mode without attaching the external monitor or turning it on, and the computer display remains blank, press the display-mode switching key  to bring up the computer display.
- **Problem:** The computer does not resume from sleep mode, or the system status indicator blinks slowly and the computer does not work.
Solution: If the system does not resume from sleep mode, it might have entered sleep or hibernation mode automatically because the battery is depleted. Check the system status indicator.
 - If the system status indicator blinks slowly, your computer is in sleep mode. Connect the ac power adapter to the computer; then press Fn.
 - If the system status indicator is off, your computer has no power or is in hibernation mode. Connect the ac power adapter to the computer; then press the power button to resume operation.

If the system still does not resume from sleep mode, your system might stop responding and you might not be able to turn off the computer. In this case, you must reset the computer. If you have not saved your data, it might be lost. To reset the computer, press and hold the power button for four seconds or more. If the system still does not respond, remove the ac power adapter and the battery.
- **Problem:** Your computer does not enter sleep or hibernation mode.
Solution: Check whether any option has been selected to disable your computer from entering sleep or hibernation mode.
If your computer tries to enter sleep mode but the request is rejected, the device attached to the USB connector might have been disabled. If this occurs, do a hot-unplug-and-plug operation for the USB device.
- **Problem:** The battery discharges slightly while the computer is in hibernation mode.
Solution: If the wakeup function is enabled, the computer consumes a small amount of power. This is not a defect. For more information, see “Power-saving modes” on page 28.

Hard disk drive problems

- **Problem:** The hard disk drive makes a rattling noise intermittently.
Solution: The rattling noise might be heard:
 - When the hard disk drive begins or finishes getting access to data
 - When you carry the hard disk drive
 - When you carry your computer

This is a normal characteristic of a hard disk drive and is not a defect.
- **Problem:** The hard disk drive does not work.
Solution: On the **Startup** menu of ThinkPad Setup, ensure that the hard disk drive is on the **Boot priority order** list. If it is on the **Excluded from boot order** list, it is disabled. Select the entry for it on the list and press Shift+1 to move it back to the **Boot priority order** list.
- **Problem:** After I have set a hard disk password, I move the hard disk drive to another computer but cannot unlock the hard disk password on the new computer.

Solution: Your computer supports an enhanced password algorithm. Computers older than yours might not support such a security function.

Solid-state drive problem

Problem: When you compress files or folders by use of the data compression function in the Windows operating system, and then decompress them, the process of writing to or reading from the files or folders is slow.

Solution: Apply the disk defragmentation tool in the Windows operating system for faster access to the data.

ThinkPad Pen Pro problem

Problem: The ThinkPad Pen Pro does not perform well.

Solution: The battery power for the pen might be low. Ensure that your computer is on. Then insert the pen into the pen slot to charge the pen for about five minutes.

Software problem

Problem: A program does not run properly.

Solution: Ensure that the problem is not being caused by the program.

Check that your computer has the minimum required memory to run the program. See the manuals supplied with the program.

Check the following:

- The program is designed to operate with your operating system.
- Other programs run properly on your computer.
- The necessary device drivers are installed.
- The program works when it is run on some other computer.

If an error message is displayed while you are using the program, see the manuals or help system supplied with the program.

If the program still does not run properly, contact your place of purchase or a service representative for help.

USB problem

Problem: A device connected to the USB connector does not work.

Solution: Ensure that the USB port is enabled in the ThinkPad Setup. Open the Device Manager window. Ensure that the USB device setup is correct, and that the assignment of computer resource and the installation of the device driver are correct. To open the Device Manager window, go to Control Panel and ensure that you view Control Panel by Category, and click **Hardware and Sound → Device Manager**. If you are prompted for an administrator password or confirmation, type the password or provide confirmation.

Refer to “Diagnosing problems” on page 87 and run a diagnostic test of the USB connector.

Docking station problem

Problem: The computer does not start when you try to turn it on, and does not respond when you try to resume operation.

Solution: Ensure that:

- The ac power adapter is connected to the docking station.
- The computer is securely attached to the docking station.

Chapter 9. Recovery information

This chapter provides information about recovery solutions. There are various methods to choose from when considering how to recover in the event of a software- or hardware-related problem. Some methods vary depending on the type of your operating system.

Recovery information for the Windows 7 operating system

This topic introduces the Lenovo recovery solutions on the Windows 7 operating system.

Creating and using recovery media

Recovery media enables you to restore the storage drive to the factory default settings after all other recovery methods have failed. It is important to create recovery media as early as possible.

Note: The recovery operations you can perform using recovery media vary depending on the operating system from which the recovery media were created. The recovery media might contain a boot medium and a data medium. Your Microsoft Windows license permits you to create only one data medium. Ensure that you store the recovery media in a safe place after you have made them.

If you did not create recovery media as a precautionary measure, you can contact Lenovo Customer Support Center and purchase a set of recovery media from Lenovo. For a list of the Lenovo Support phone numbers for your country or region, go to:

<https://pcsupport.lenovo.com/supportphonenumberlist>

The data on the recovery media can be used only for the following purposes:

- Reinstalling the programs and device drivers on your computer
- Reinstalling the operating system
- Modifying the data files on the hard disk drive using the additional files

Creating recovery media

To create recovery media, you need a set of discs or a USB storage device (with at least 16 GB of storage capacity). The actual disc number or USB capacity that is required depends on the size of the recovery image.

Attention: Creating recovery media will delete anything stored on the discs or USB storage device. To avoid data loss, make a backup copy of all the data that you want to keep.

To create recovery media, click **Start → All Programs → Lenovo PC Experience**. In the prompted window, double-click **Lenovo Tools → Factory Recovery Disks**. Then, follow the instructions on the screen.

Using recovery media

Attention: During the recovery process, all the files currently on the storage device of your computer will be deleted and replaced by the factory default settings.

To use the recovery media, do the following:

- If you have created the recovery media with discs, do the following:
 1. If your computer does not have an internal optical drive, connect an external optical drive to the computer.

2. Turn on the computer and repeatedly press F12 until the Boot Menu window opens.
 3. In the Boot Menu window, select the optical drive (internal or external) as the first boot device. Then, insert the discs into the optical drive and press Enter. The recovery process starts.
 4. Follow the instructions on the screen to complete the operation.
- If you have created the recovery media with a USB storage device, do the following:
 1. Attach the USB storage device to one of the USB connectors on your computer.
 2. Turn on the computer and repeatedly press F12 until the Boot Menu window opens.
 3. In the Boot Menu window, select the USB storage device as the first boot device and press Enter. The recovery process starts.
 4. Follow the instructions on the screen to complete the operation.

Note: After restoring your computer to the factory default settings, you might have to reinstall the device drivers for some devices. See “Reinstalling preinstalled programs and device drivers” on page 106.

Reinstalling preinstalled programs and device drivers

Your computer enables you to reinstall preinstalled programs and device drivers.

Reinstalling preinstalled programs

To reinstall programs preinstalled on your computer, do the following:

1. Turn on your computer.
2. Go to C:\swtools.
3. Open the apps folder. The folder contains several subfolders named for various preinstalled programs.
4. Open the subfolder and locate the EXE file.
5. Double-click the EXE file and follow the instructions on the screen to complete the installation.

Reinstalling preinstalled device drivers

Attention: Reinstalling device drivers will change the current configuration of your computer. Reinstall device drivers only when it is necessary to solve a problem with your computer.

To reinstall a device driver for a factory-installed device, do the following:

1. Turn on your computer.
2. Go to C:\swtools.
3. Open the Drivers folder and locate the subfolder that is named after the factory-installed device in your computer, such as AUDIO or VIDEO.
4. Open the subfolder for the device.
5. Reinstall the device driver by one of the following methods:
 - If the device subfolder contains an EXE file, double-click the EXE file and follow the instructions on the screen to complete the installation.
 - If the device subfolder contains a readme TXT file, the device driver installation information is included in the readme file. Follow the instructions to complete the installation.
 - If the device subfolder contains an INF file, right-click the INF file and select **Install**. Then follow the instructions on the screen to complete the installation.

If you need updated device drivers for your computer, download and install them from the Lenovo Support Web site at:

Recovery information for the Windows 10 operating system

This topic provides information about the Windows recovery solutions on the Windows 10 operating system.

Resetting your computer

If your computer does not perform well, you might consider resetting your computer. In the resetting process, you can choose to keep your files or remove them, and then reinstall the Windows operating system.

To reset your computer, do the following:

Note: The items in the graphical user interface (GUI) might change without notice.

1. Open the Start menu, and then click **Settings → Update & Security → Recovery**.
2. In the **Reset this PC** section, click **Get started**.
3. Follow the instructions on the screen to reset your computer.

Using advanced startup options

The advanced startup options enable you to do the following:

- Change the firmware settings of the computer
- Change the startup settings of the Windows operating system
- Start the computer from an external device
- Restore the Windows operating system from a system image

To use advanced startup options, do the following:

Note: The items in the graphical user interface (GUI) might change without notice.

1. Open the Start menu, and then click **Settings → Update & security → Recovery**.
2. In the **Advanced startup** section, click **Restart now → Troubleshoot → Advanced options**.
3. Select a startup option you want, and then follow the instructions on the screen.

Recovering your operating system if Windows 10 fails to start

The Windows recovery environment on your computer operates independently from the Windows 10 operating system. It enables you to recover or repair the operating system even if the Windows 10 operating system fails to start.

After two consecutive failed boot attempts, the Windows recovery environment starts automatically. Then you can choose repair and recovery options by following the on-screen instructions.

Note: Ensure that your computer is connected to ac power during the recovery process.

Creating and using a recovery USB drive

You can create a recovery USB drive as a backup for the Windows recovery programs. With the recovery USB drive, you can troubleshoot and fix the problems even if the preinstalled Windows recovery programs are damaged.

It is recommended that you create a recovery USB drive as early as possible. If you did not create a recovery USB drive as a precautionary measure, you can contact Lenovo Customer Support Center and purchase one from Lenovo. For a list of the Lenovo Support phone numbers for your country or region, go to:

<https://pcsupport.lenovo.com/supportphonenumberlist>

Creating a recovery USB drive

To create a recovery USB drive, you need a USB drive with at least 16 GB of storage capacity. The actual USB capacity that is required depends on the size of the recovery image.

Attention: The creation process will delete anything stored on the USB drive. To avoid data loss, make a backup copy of all the data that you want to keep.

To create a recovery USB drive, do the following:

Note: Ensure that your computer is connected to ac power during the following process.

1. Connect a proper USB drive (at least 16 GB of storage) to the computer.
2. Type *recovery* in the search box on the taskbar. Then click **Create a recovery drive**.
3. Click **Yes** in the User Account Control window to allow the Recovery Media Creator program to start.
4. In the Recovery Drive window, follow the instructions on the screen to create a recovery USB drive.

Using the recovery USB drive

If you cannot start your computer, refer to the corresponding information in the topic “Troubleshooting” on page 88 to try to solve the problem by yourself. If you still cannot start your computer, use the recovery USB drive to recover your computer.

To use a recovery USB drive, do the following:

Note: Ensure that your computer is connected to ac power during the following process.

1. Connect the recovery USB drive to the computer.
2. Turn on or restart the computer. Before the Windows operating system starts, repeatedly press F12. The Boot Menu window opens.
3. Select the recovery USB drive as the boot device.
4. Select a preferred keyboard layout.
5. Click **Troubleshoot** to display optional recovery solutions.
6. Select a corresponding recovery solution according to your situation. Then follow the instructions on the screen to complete the process.

Chapter 10. Replacing devices

This chapter provides instructions on how to install or replace hardware for your computer.

Static electricity prevention

Static electricity, although harmless to you, can seriously damage computer components and options. Improper handling of static-sensitive parts can cause damage to the part. When you unpack an option or a Customer Replaceable Unit (CRU), do not open the static-protective package until the instructions direct you to install the part.

When you handle options or CRUs, or perform any work inside the computer, take the following precautions to avoid static-electricity damage:

- Limit your movement. Movement can cause static electricity to build up around you.
- Always handle components carefully. Handle adapters, memory modules, and other circuit boards by the edges. Never touch exposed circuitry.
- Prevent others from touching the components.
- Before you install a static-sensitive option or CRU, do either of the following to reduce static electricity in the package and your body:
 - Touch the static-protective package that contains the part to a metal expansion-slot cover for at least two seconds.
 - Touch the static-protective package that contains the part to other unpainted metal surface on the computer for at least two seconds.
- When possible, remove the static-sensitive part from the static-protective package and install the part without setting it down. When this is not possible, place the static-protective package on a smooth, level surface and place the part on the package.
- Do not place the part on the computer cover or other metal surface.

Replacing the removable battery

Before you start, print these instructions. Read the important safety information first. See “Important safety information” on page v.

This system supports only batteries specially designed for this specific system and manufactured by Lenovo or an authorized builder. The system does not support unauthorized batteries or batteries designed for other systems. If an unauthorized battery or a battery designed for another system is installed, the system does not charge and the following message is displayed:

“The battery installed is not supported by this system and will not charge. Please replace the battery with the correct Lenovo battery for this system.”

Attention: Lenovo has no responsibility for the performance or safety of unauthorized batteries, and provides no warranties for failures or damage arising out of their use.

 **DANGER**

If the rechargeable battery is incorrectly replaced, there is danger of an explosion. The battery contains a small amount of harmful substances. To avoid possible injury:

- Replace only with a battery of the type recommended by Lenovo.
- Keep the battery away from fire.
- Do not expose it to excessive heat.
- Do not expose it to water or rain.
- Do not short-circuit it.
- Do not drop, crush, puncture, or subject to strong forces. Battery abuse or mishandling can cause the battery to overheat, which can cause gasses or flame to “vent” from the battery.

To replace the removable battery, do the following:

1. Disconnect the ac power from the computer and turn off the computer. Close the computer display and turn the computer over.
2. Unlock the battery latch **1**. The battery ejects in the direction as shown by arrow **2**.

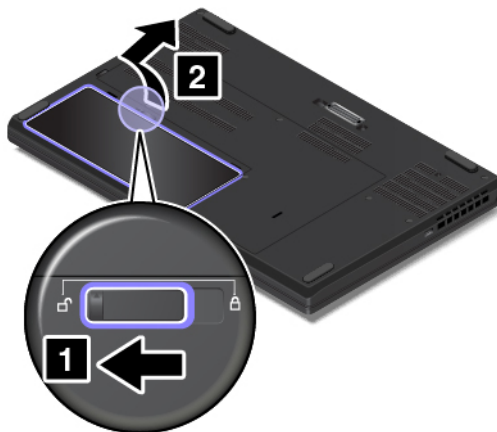

3. Remove the battery.

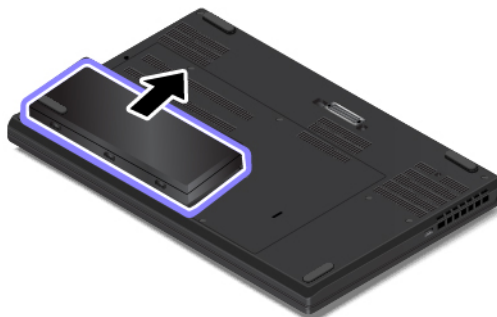

4. Insert a new battery as shown. Ensure that the battery is firmly installed in place.

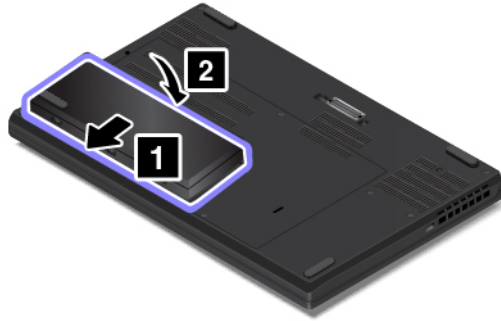

5. Lock the battery latch.

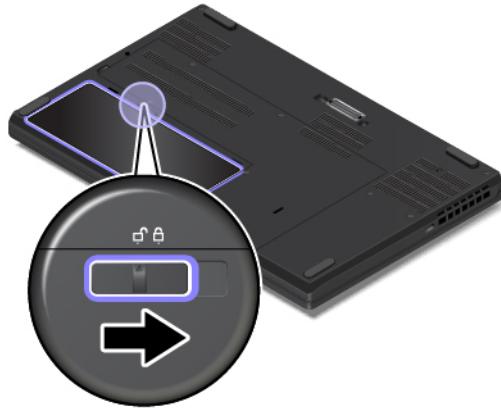

6. Turn the computer over again. Connect the computer to ac power.

Installing or replacing the micro SIM card

Before you start, print these instructions. Read the important safety information first. See “Important safety information” on page v.

Micro SIM card is a small plastic card with an Integrated Circuit (IC) chip mounted on one side of the card.

To install or replace the micro SIM card, do the following:

1. Disconnect the ac power from the computer and turn off the computer. Close the computer display and turn the computer over.
2. Remove the removable battery. See “Replacing the removable battery” on page 109.
3. Gently push the micro SIM card to eject it **1**, and then slide it out of the slot **2**. Install a new micro SIM card **3**.

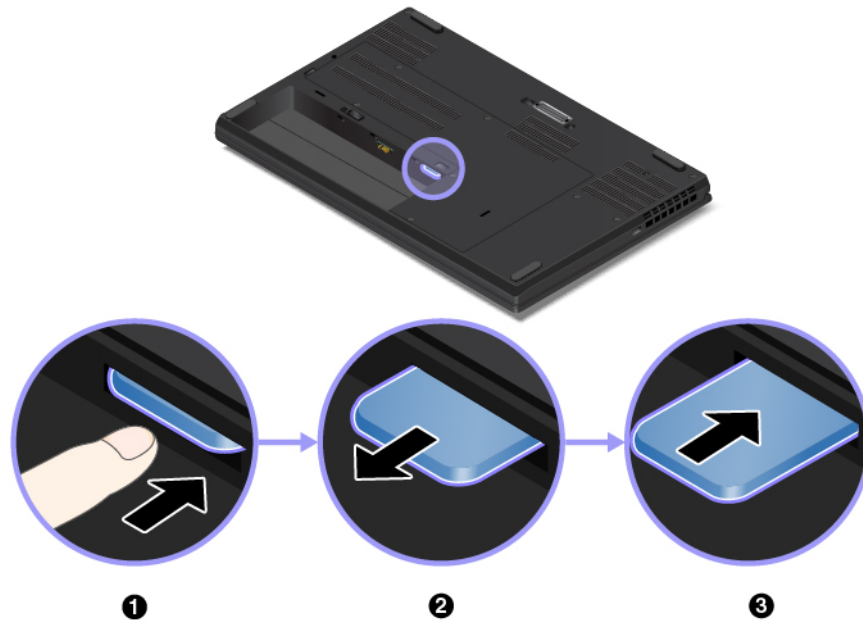

4. Install the removable battery. See “Replacing the removable battery” on page 109.
5. Turn the computer over. Connect the ac power adapter and all cables to the computer.

Replacing the bottom cover

Before you start, print these instructions. Read the important safety information first. See “Important safety information” on page v.

To replace the bottom cover, do the following:

1. Disconnect the ac power from the computer and turn off the computer. Close the computer display and turn the computer over.
2. Remove the removable battery. See “Replacing the removable battery” on page 109.
3. Loosen the screws that secure the bottom cover.

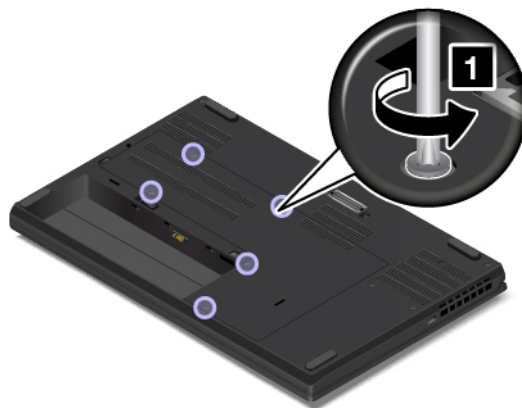

4. Slightly lift the left side of the bottom cover with your finger. Remove the bottom cover in the direction as shown by the arrow.

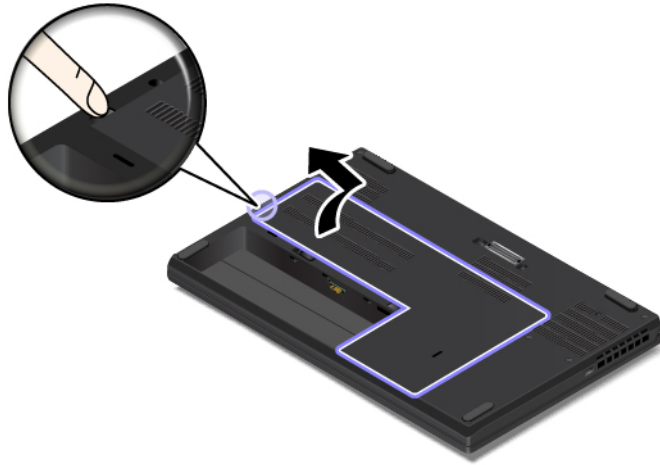

5. Install the new bottom cover as shown. Ensure that the latches of the bottom cover are secured under the base cover assembly.

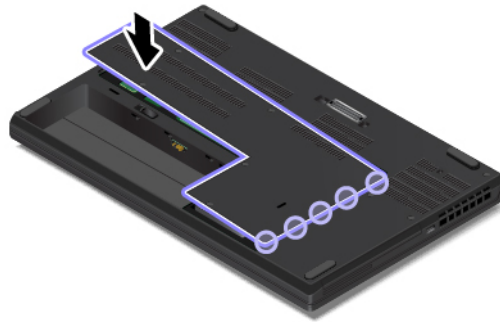

6. Tighten the screws to secure the bottom cover.

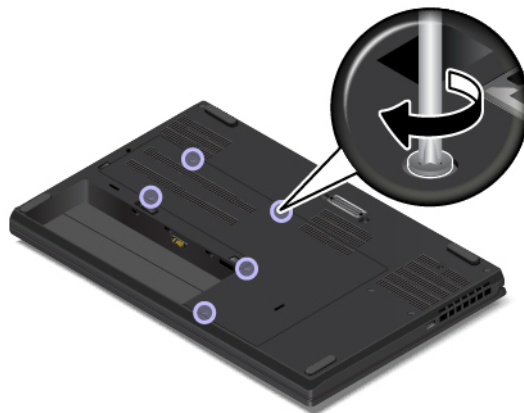

7. Install the removable battery. See “Replacing the removable battery” on page 109.
8. Turn the computer over. Connect the ac power adapter and all cables to the computer.

Replacing the optical drive

Before you start, print these instructions. Read the important safety information first. See “Important safety information” on page v.

To replace the optical drive, do the following:

1. Disconnect the ac power from the computer and turn off the computer. Close the computer display and turn the computer over.
2. Remove the removable battery. See “Replacing the removable battery” on page 109.
3. Remove the bottom cover. See “Replacing the bottom cover” on page 112.
4. Remove the screw **1** and pull out the optical drive out of the computer **2**.

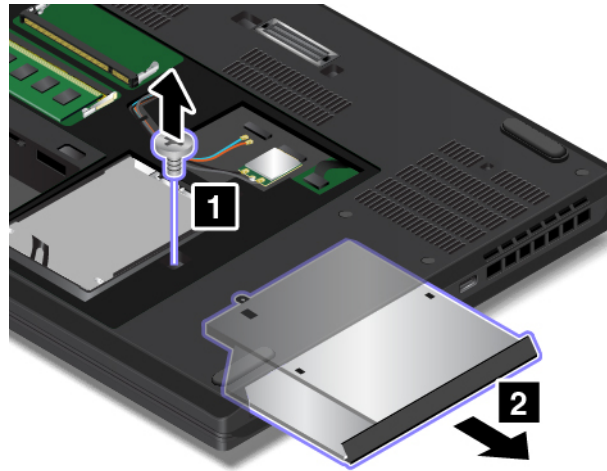

5. Insert a new optical drive **1**, and then secure the screw **2**.

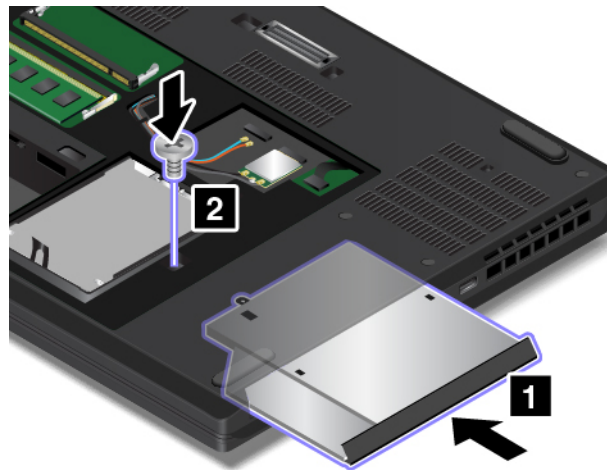

6. Install the bottom cover. See “Replacing the bottom cover” on page 112.
7. Install the removable battery. See “Replacing the removable battery” on page 109.
8. Turn the computer over. Connect the ac power adapter and all cables to the computer.

Replacing the wireless-WAN card

The following information is only for user-installable modules.

Before you start, print these instructions. Read the important safety information first. See “Important safety information” on page v.

Your computer might be equipped with a wireless-WAN card. To replace the wireless-WAN card, do the following:

Attention: Before you start installing a wireless-WAN card, touch a metal table or a grounded metal object. This action reduces any static electricity from your body. Static electricity could damage the card.

1. Disconnect the ac power from the computer and turn off the computer. Close the computer display and turn the computer over.
2. Remove the removable battery. See “Replacing the removable battery” on page 109.
3. Remove the bottom cover. See “Replacing the bottom cover” on page 112.
4. If a tool is provided with the new wireless-WAN card to help you disconnect cables, use the tool to disconnect the cables from the wireless-WAN card. Otherwise, hold the cable connector with your fingers and gently disconnect the cables from the wireless-WAN card.

Note: A Mylar film might cover the wireless WAN card. To access the wireless WAN card, open the film first.

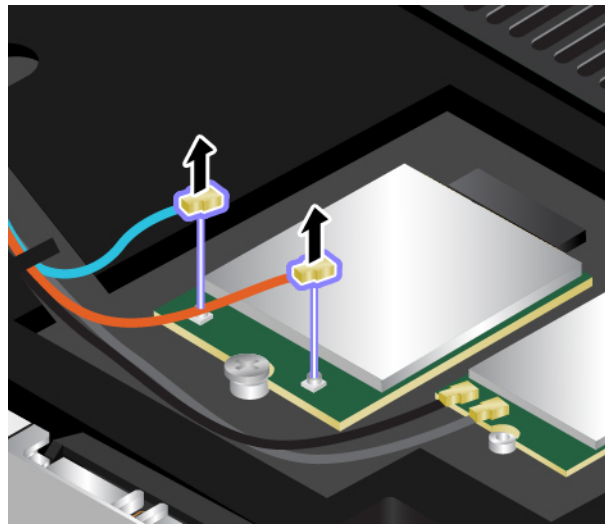

5. Remove the screw. The wireless-WAN card is released from the secured position and pivots upward.

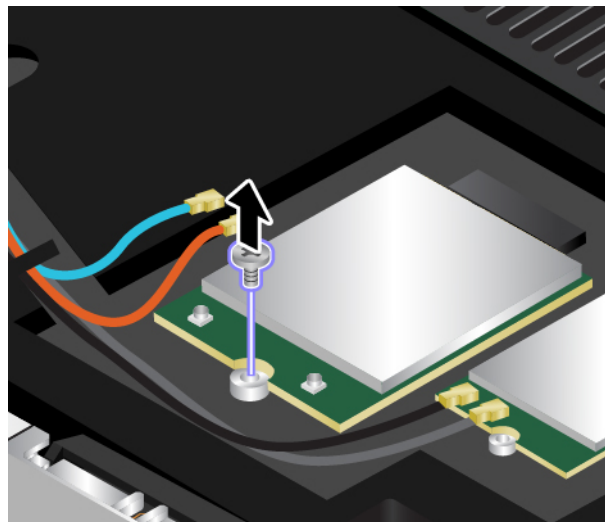

6. Carefully remove the wireless-WAN card out of the slot.

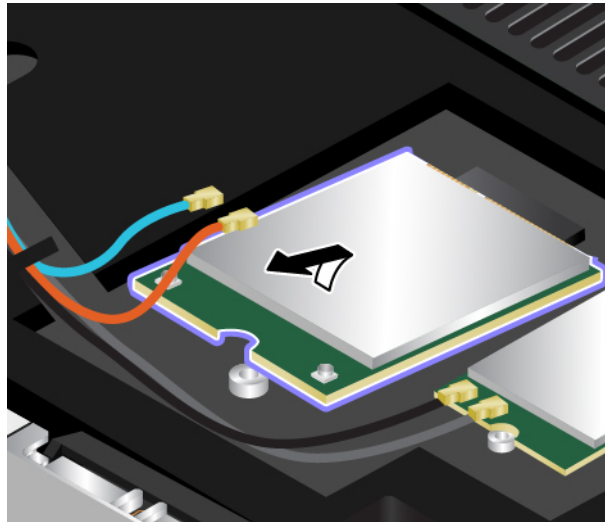

7. Align the contact edge of the new wireless-WAN card with the key in the slot. Then carefully insert the new wireless-WAN card into the slot at an angle of about 20 degrees. Pivot the wireless-WAN card downward.

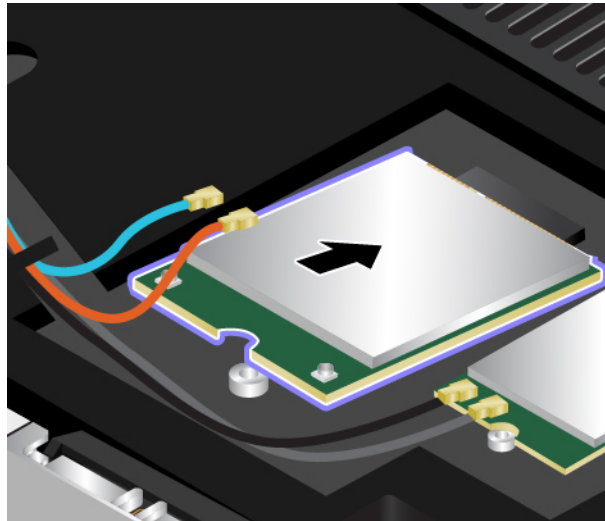

8. Install the screw to secure the wireless-WAN card in place.

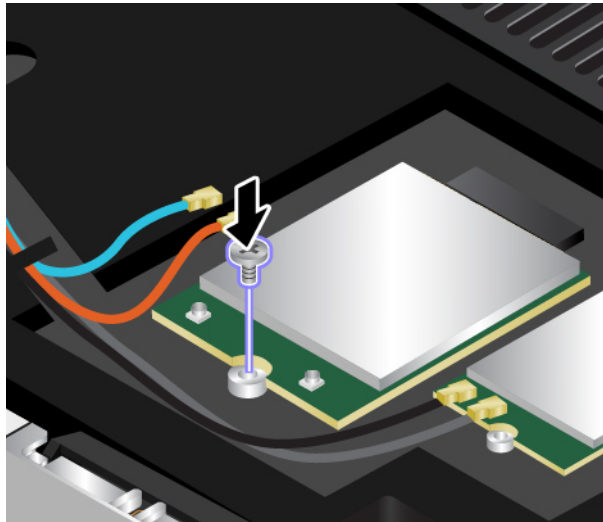

9. Connect the cables to the wireless-WAN card. Ensure that you attach the red cable to the main connector and the blue cable to the auxiliary connector on the wireless-WAN card.

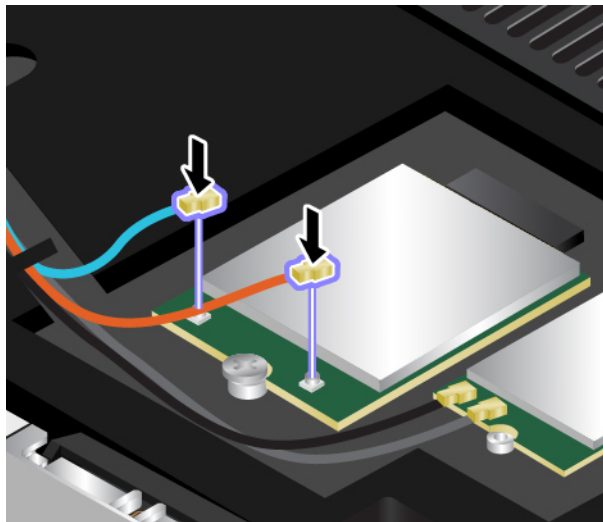

10. Install the bottom cover. See “Replacing the bottom cover” on page 112.
11. Install the removable battery. See “Replacing the removable battery” on page 109.
12. Turn the computer over. Connect the ac power adapter and all cables to the computer.

Replacing the M.2 solid-state drive

Before you start, print these instructions. Read the important safety information first. See “Important safety information” on page v.

Attention: The M.2 solid-state drive is sensitive. Incorrect handling can cause damage and permanent loss of data. Observe the following guidelines:

- Replace the M.2 solid-state drive only if you upgrade it or have it repaired. The connectors and slot of the M.2 solid-state drive are not designed for frequent changes or drive swapping.
- Do not drop the M.2 solid-state drive or subject it to physical shocks. Put the M.2 solid-state drive on a material, such as soft cloth, that absorbs any physical shocks.
- Do not apply pressure to the cover of the M.2 solid-state drive.

- Do not touch the connector.
- Before removing the M.2 solid-state drive, make a backup copy of all the information on it, and then turn off the computer.
- Never remove the M.2 solid-state drive while the computer is operating, in sleep mode, or in hibernation mode.

Your computer has two M.2 solid-state drive slots. Ensure that you select the correct M.2 solid-state drive when you configure the system settings in ThinkPad Setup.

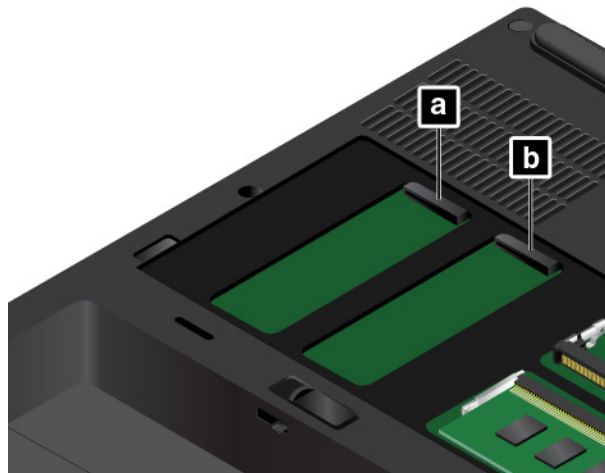

Slot	Slot label on computer	Corresponding menu selection in ThinkPad Setup
a	Slot 1	ATA HDD3 or NVMe1
b	Slot 0	ATA HDD2 or NVMe0

To replace the M.2 solid-state drive, do the following:

1. Disconnect the ac power from the computer and turn off the computer. Close the computer display and turn the computer over.
2. Remove the removable battery. See “Replacing the removable battery” on page 109.
3. Remove the bottom cover. See “Replacing the bottom cover” on page 112.
4. Remove the screw that secures the M.2 solid-state drive.

Note: A Mylar film might cover the solid-state drive. To access the solid-state drive, open the film first.

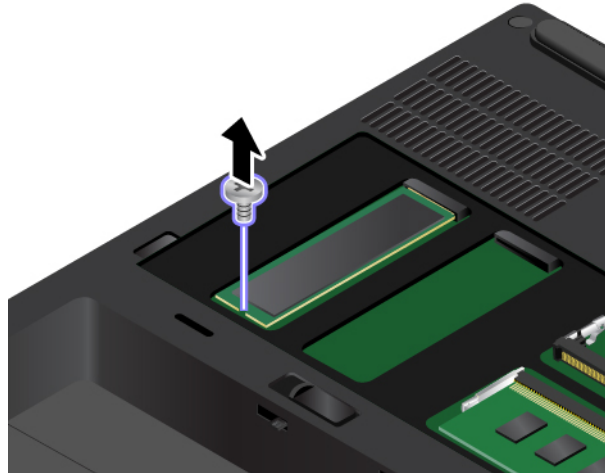

5. Carefully remove the M.2 solid-state drive out of the slot.

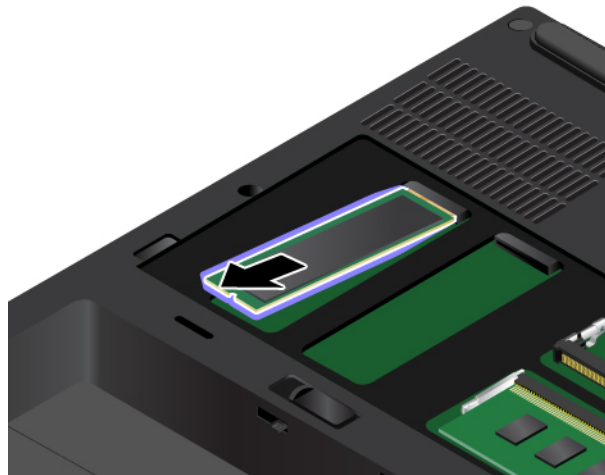

6. Align the contact edge of the new M.2 solid-state drive with the key in the slot. Then carefully insert the M.2 solid-state drive into the slot at an angle of about 20 degrees **1**. Pivot the M.2 solid-state drive downward **2**.

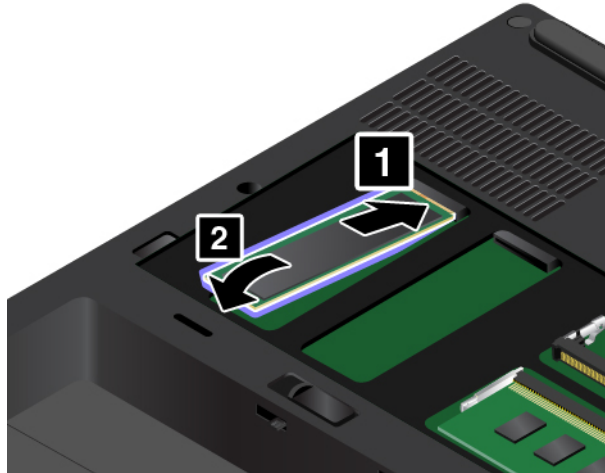

7. Install the screw to secure the M.2 solid-state drive.

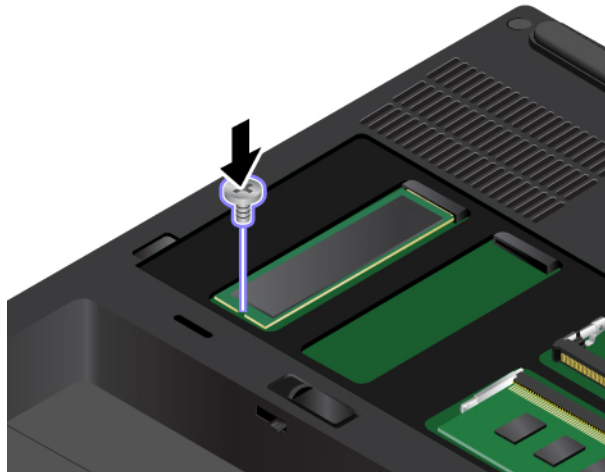

8. Install the bottom cover. See “Replacing the bottom cover” on page 112.

9. Install the removable battery. See “Replacing the removable battery” on page 109.

10. Turn the computer over. Connect the ac power adapter and all cables to the computer.

Replacing the keyboard

Before you start, print these instructions. Read the important safety information first. See “Important safety information” on page v.

Removing the keyboard

To remove the keyboard, do the following:

1. Disconnect the ac power from the computer and turn off the computer. Close the computer display and turn the computer over.
2. Remove the removable battery. See “Replacing the removable battery” on page 109.
3. Remove the bottom cover. See “Replacing the bottom cover” on page 112.
4. Remove the screws that secure the keyboard.

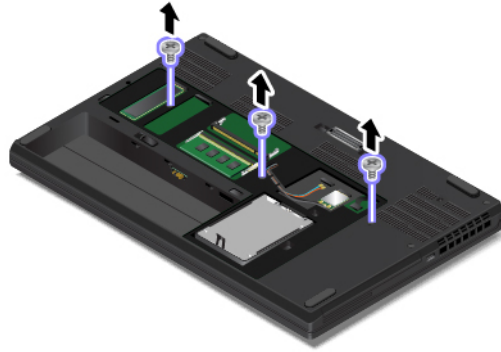

5. Turn the computer over and open the display. Slightly push the keyboard in the direction as shown by arrows **1** to release the latches from the keyboard bezel. Lift the keyboard slightly as shown by arrow **2**.



6. Put the keyboard on the palm rest as shown and detach the connectors. Remove the keyboard.

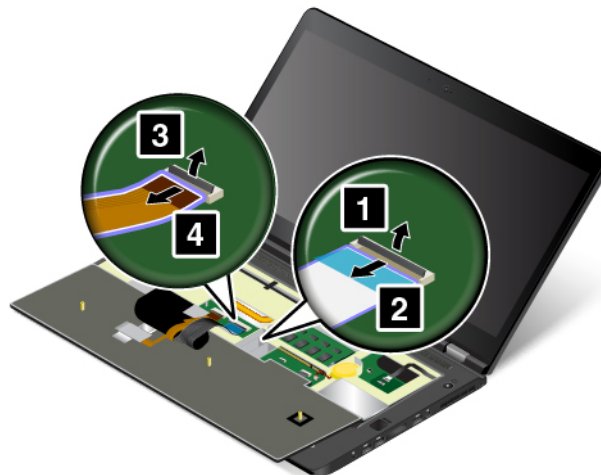

Installing the new keyboard

To install the new keyboard, do the following:

1. Attach the connectors as shown.



2. Insert the keyboard as shown. Ensure that the front edge of the keyboard (the edge that is close to the display) is under the keyboard bezel.



3. Slide the keyboard in the direction as shown by the arrows. Ensure that the latches are secured under the keyboard frame.



4. Close the computer display and turn the computer over. Install the screws to secure that keyboard.

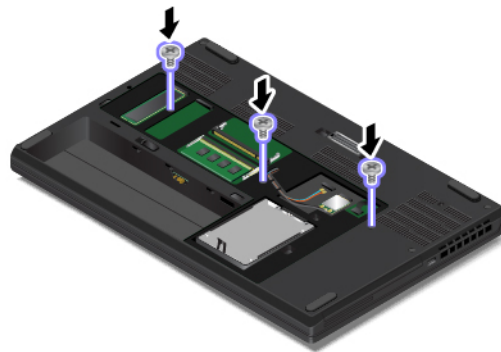

5. Install the bottom cover. See “Replacing the bottom cover” on page 112.
6. Install the removable battery. See “Replacing the removable battery” on page 109.
7. Turn the computer over. Connect the ac power adapter and all cables to the computer.

Replacing the coin-cell battery

Before you start, print these instructions. Read the important safety information first. See “Important safety information” on page v.

 **DANGER**

If the coin-cell battery is incorrectly replaced, there is danger of an explosion. The coin-cell battery contains a small amount of harmful substance. To avoid possible injury:

- Replace only with a battery of the type recommended by Lenovo.
- Keep the battery away from fire.
- Do not expose it to excessive heat.
- Do not expose it to water or rain.
- Do not short-circuit it.
- Do not drop, crush, puncture the battery, or make it subject to strong forces. Battery abuse or mishandling can cause the battery to overheat, which can cause gasses or flame to “vent” from the battery or coin-cell battery.

To replace the coin-cell battery, do the following:

1. Disconnect the ac power from the computer and turn off the computer. Close the computer display and turn the computer over.
2. Remove the removable battery. See “Replacing the removable battery” on page 109.
3. Remove the bottom cover. See “Replacing the bottom cover” on page 112.
4. Remove the keyboard. See “Replacing the keyboard” on page 120.
5. Loosen the screw **1** and remove the shielding bracket **2**.

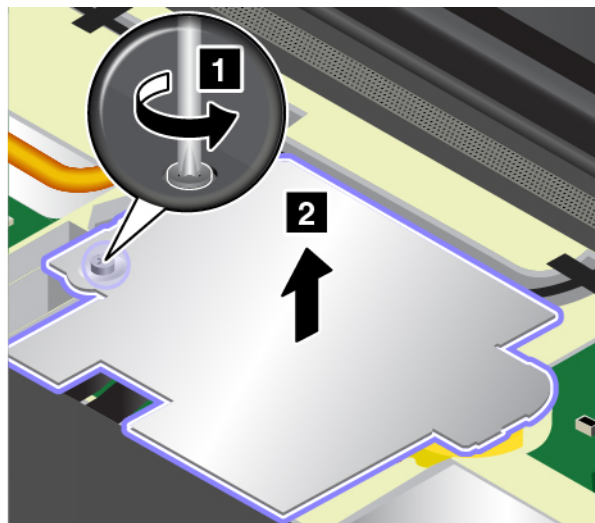

6. Detach the connector **1** and remove the coin-cell battery **2**.

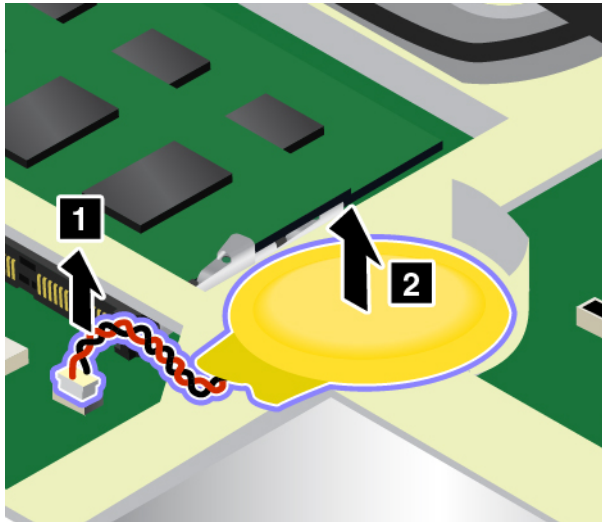

7. Install the new coin-cell battery **1** and attach the connector **2**.

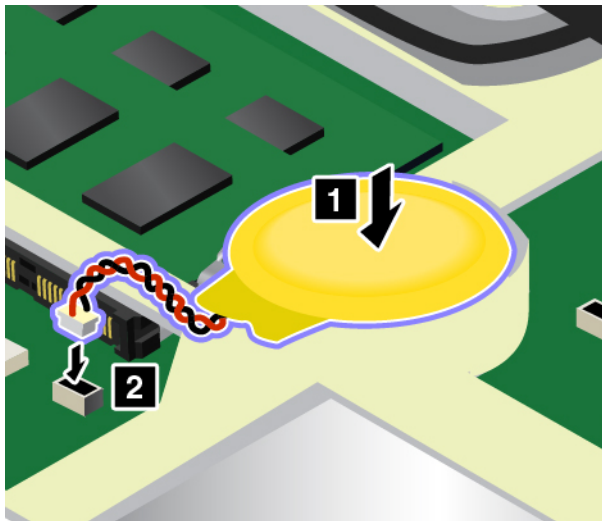

8. Install the shielding bracket **1** and secure the screw **2**.

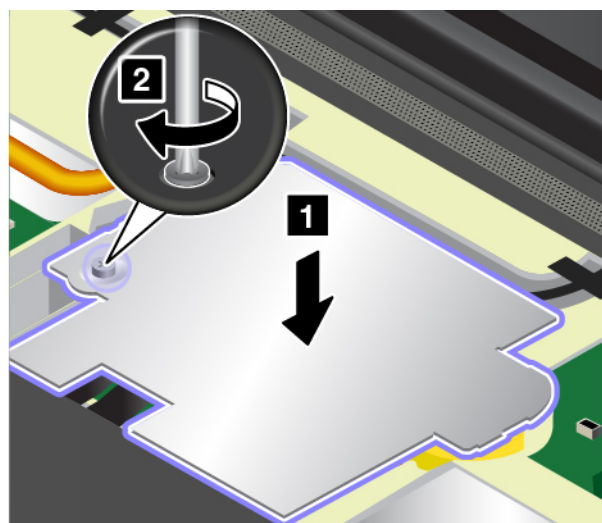

9. Install the keyboard. See “Replacing the keyboard” on page 120.
10. Install the bottom cover. See “Replacing the bottom cover” on page 112.
11. Install the removable battery. See “Replacing the removable battery” on page 109.
12. Turn the computer over. Connect the ac power adapter and all cables to the computer.

Replacing the hard disk drive under the bottom cover

Before you start, print these instructions. Read the important safety information first. See “Important safety information” on page v.

Attention: The hard disk drive is very sensitive. Incorrect handling can cause damage and permanent loss of data. Observe the following guidelines:

- Replace the hard disk drive only if you upgrade it or have it repaired. The connectors and slot of the hard disk drive are not designed for frequent changes or drive swapping.
- Do not drop the hard disk drive or subject it to physical shocks. Put the hard disk drive on a material, such as soft cloth, that absorbs any physical shocks.
- Do not apply pressure to the cover of the hard disk drive.
- Do not touch the connector.
- Before removing the hard disk drive, make a backup copy of all the information on it, and then turn off the computer.
- Never remove the hard disk drive while the computer is operating, in sleep mode, or in hibernation mode.

To replace the hard disk drive under the bottom cover, do the following:

1. Disconnect the ac power from the computer and turn off the computer. Close the computer display and turn the computer over.
2. Remove the removable battery. See “Replacing the removable battery” on page 109.
3. Remove the bottom cover. See “Replacing the bottom cover” on page 112.
4. Pull the tape to take the hard disk drive with bracket out of the drive bay.

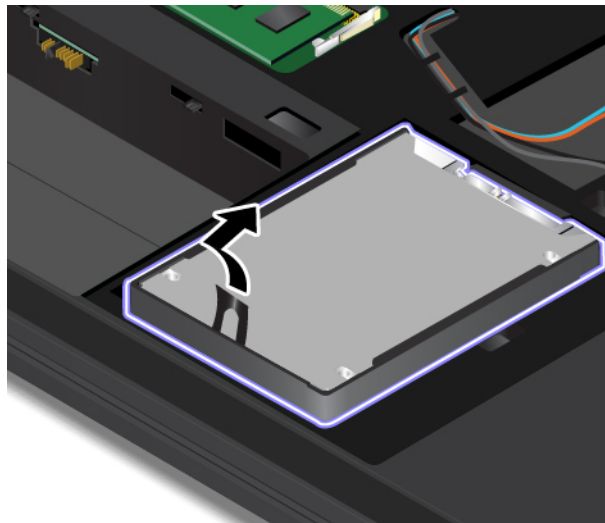

5. Insert the new hard disk drive with bracket into the bay.

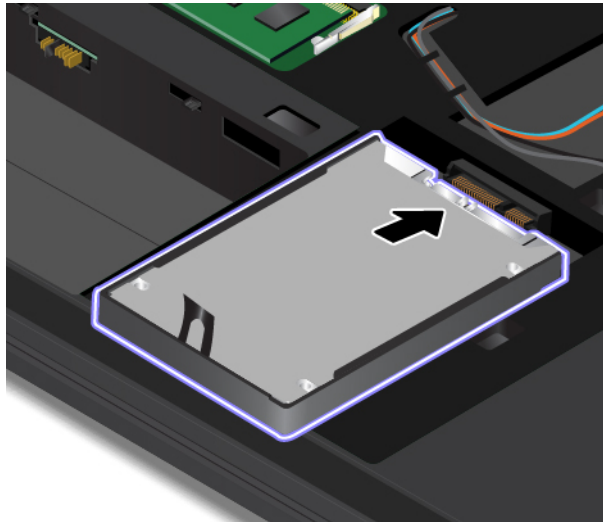

6. Install the bottom cover. See “Replacing the bottom cover” on page 112.
7. Install the removable battery. See “Replacing the removable battery” on page 109.
8. Turn the computer over. Connect the ac power adapter and all cables to the computer.

Replacing the hard disk drive in the optical drive bay

Before you start, print these instructions. Read the important safety information first. See “Important safety information” on page v.

To replace the hard disk drive in the optical drive bay, do the following:

1. Disconnect the ac power from the computer and turn off the computer. Close the computer display and turn the computer over.
2. Remove the removable battery. See “Replacing the removable battery” on page 109.
3. Remove the bottom cover. See “Replacing the bottom cover” on page 112.
4. Remove the screw **1** and take out the hard-disk-drive adapter that contains the hard disk drive **2**.

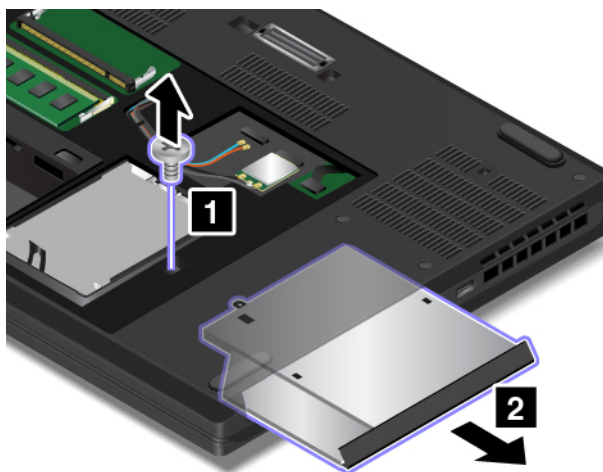

5. Loosen the screws **1** and open the cover **2**.

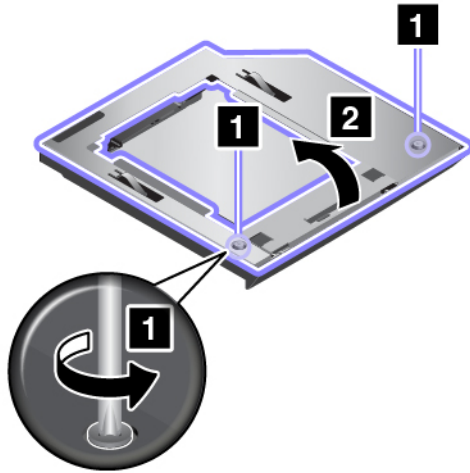

6. Take out the hard disk drive with bracket as shown.

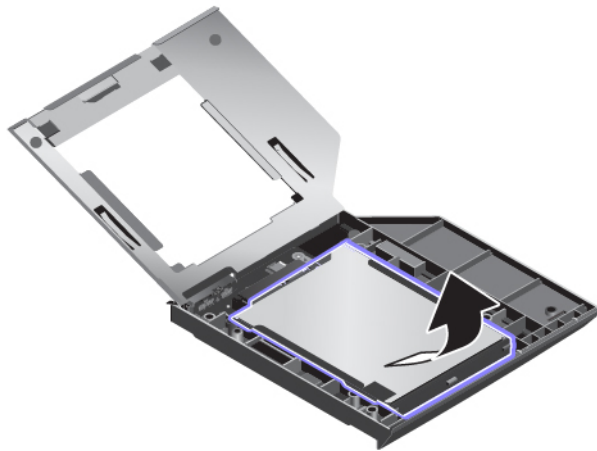

7. Install the hard disk drive with bracket into the hard-disk-drive adapter.

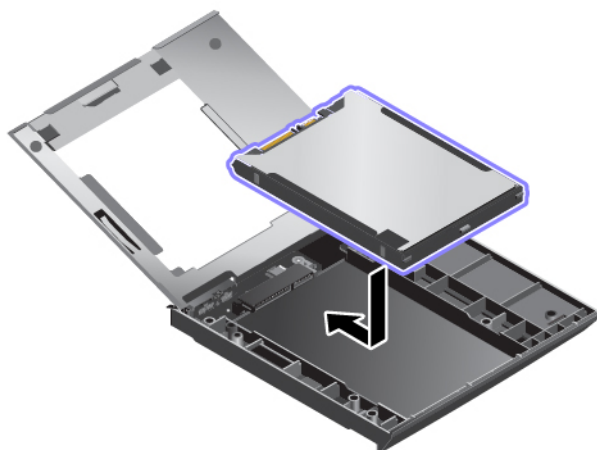

8. Close the cover.

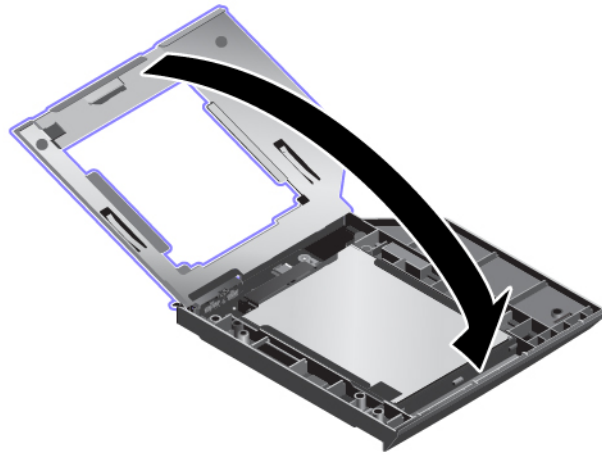

9. Secure the screws **1**.

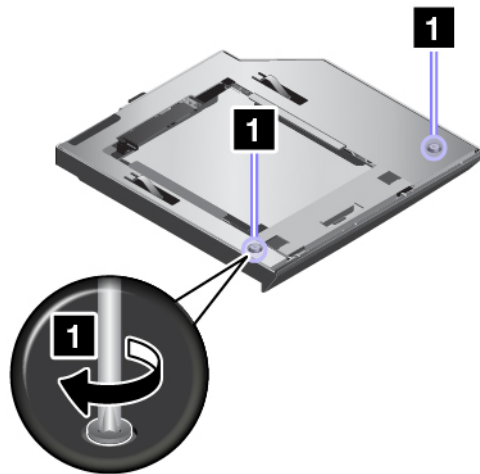

10. Insert the hard-disk-drive adapter **1** into the bay, and then secure the screw **2**.

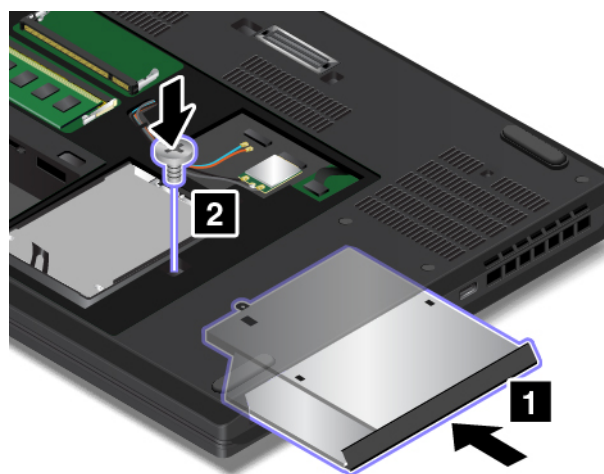

11. Install the bottom cover. See “Replacing the bottom cover” on page 112.

12. Install the removable battery. See “Replacing the removable battery” on page 109.

13. Turn the computer over. Connect the ac power adapter and all cables to the computer.

Replacing the memory module under the bottom cover

Before you start, print these instructions. Read the important safety information first. See “Important safety information” on page v.

Increasing memory capacity is an effective way to make programs run faster. To replace or add a memory module, read the following prerequisites, and then the instructions.

Note: The operating speed of the memory module has dependency on the system configuration. In some conditions, the memory module in your computer might not be able to operate at the maximum speed.

Attention:

- Before you start, touch a metal table or a grounded metal object. This action reduces any static electricity from your body. Static electricity could damage the memory module.
- Do not touch the contact edge of the memory module. Otherwise the memory module might get damaged.

To replace the memory module, do the following:

1. Disconnect the ac power from the computer and turn off the computer. Close the computer display and turn the computer over.
2. Remove the removable battery. See “Replacing the removable battery” on page 109.
3. Remove the bottom cover. See “Replacing the bottom cover” on page 112.
4. Open the latches on both sides of the memory slot at the same time **1**, and then remove the memory module **2**.

Note: A Mylar film might cover the memory module. To access the memory module, open the film first.

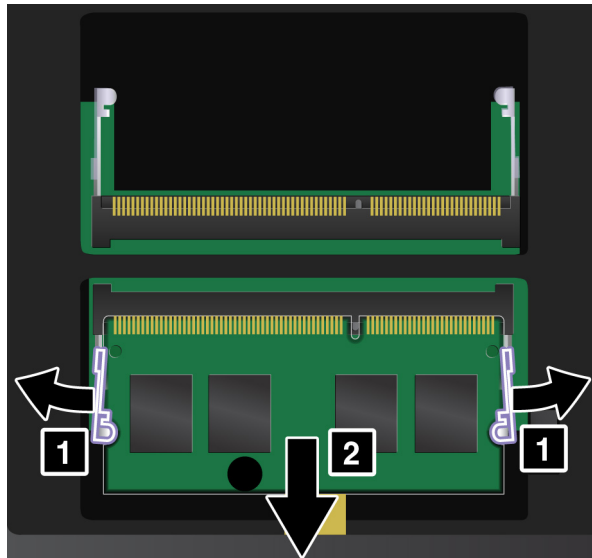

5. Insert the memory module into the memory slot at an angle of about 20 degrees **1**. Pivot the memory module downward until it snaps into place **2**. Ensure that the memory module is firmly installed in the memory slot and cannot be moved easily.

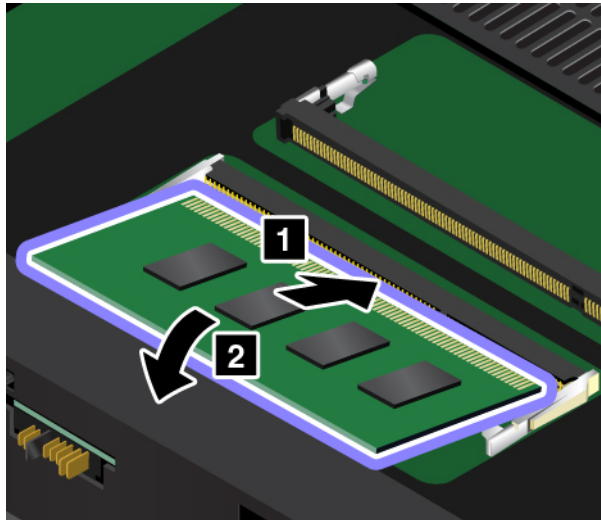

6. Install the bottom cover. See “Replacing the bottom cover” on page 112.
7. Install the removable battery. See “Replacing the removable battery” on page 109.
8. Turn the computer over. Connect the ac power adapter and all cables to the computer.

Replacing the memory module under the keyboard

Before you start, print these instructions. Read the important safety information first. See “Important safety information” on page v.

Increasing memory capacity is an effective way to make programs run faster. To replace or add a memory module, read the following prerequisites, and then the instructions.

Note: The operating speed of the memory module has dependency on the system configuration. In some conditions, the memory module in your computer might not be able to operate at the maximum speed.

Attention:

- Before you start, touch a metal table or a grounded metal object. This action reduces any static electricity from your body. Static electricity could damage the memory module.
- Do not touch the contact edge of the memory module. Otherwise the memory module might get damaged.

To replace the memory module under the keyboard, do the following:

1. Disconnect the ac power from the computer and turn off the computer. Close the computer display and turn the computer over.
2. Remove the removable battery. See “Replacing the removable battery” on page 109.
3. Remove the bottom cover. See “Replacing the bottom cover” on page 112.
4. Remove the keyboard. See “Replacing the keyboard” on page 120
5. Loosen the screw **1** and remove the shielding bracket **2**.

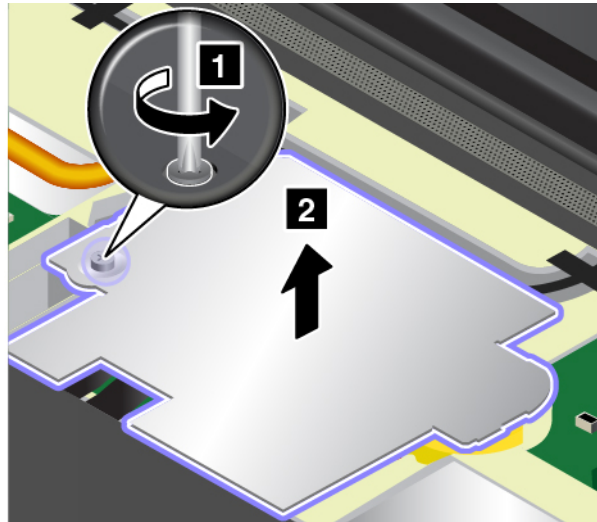

6. Open the latches on both sides of the memory slot at the same time **1**, and then remove the memory module **2**.

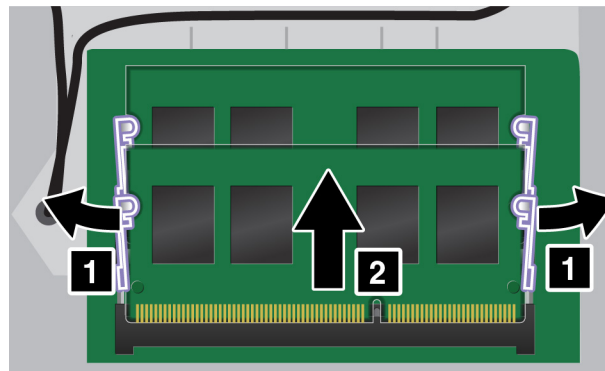

7. Insert the memory module into the memory slot at an angle of about 20 degrees **1**. Pivot the memory module downward until it snaps into place **2**. Ensure that the memory module is firmly installed in the memory slot and cannot be moved easily.

Note: If you install only one memory module, install it into the slot that is close to the display.

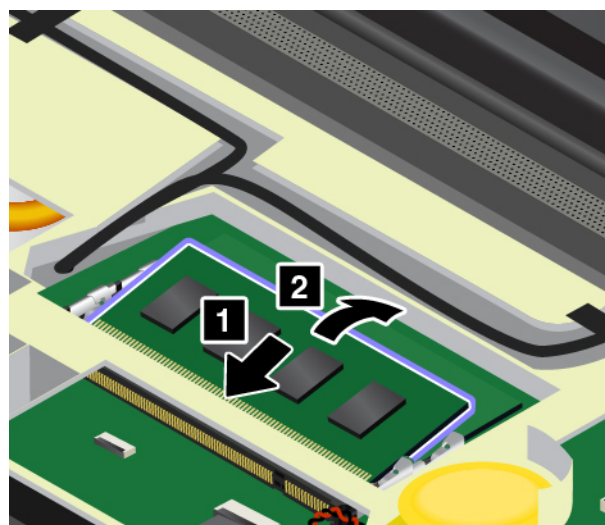

8. Install the shielding bracket **1** and secure the screw **2**.

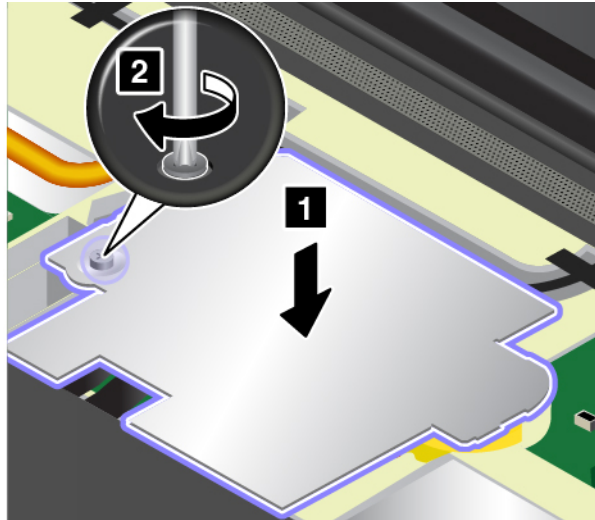

9. Install the keyboard. See “Replacing the keyboard” on page 120.
10. Install the bottom cover. See “Replacing the bottom cover” on page 112.
11. Install the removable battery. See “Replacing the removable battery” on page 109.
12. Turn the computer over. Connect the ac power adapter and all cables to the computer.

Chapter 11. Getting support

This chapter provides information about getting help and support from Lenovo.

Before you contact Lenovo

Often, you can solve your computer problems by referring to the information in the explanations of error codes, running diagnostic programs, or by consulting the Lenovo Support Web site.

Registering your computer

Register your computer with Lenovo. For more information, see “Registering your computer” on page 17.

Downloading system updates

Downloading updated software might resolve problems you experience with your computer.

To download updated software, go to the following Web site and follow the instructions on the screen:

<https://support.lenovo.com>

Recording information

Before you talk to a Lenovo representative, record the following important information about your computer.

Recording problem symptoms and details

Collect the answers to the following questions before you call for help. Then, you are able to get help as quickly as possible.

- What is the problem? Is it continuous or intermittent?
- Is there an error message? What is the error code, if any?
- What operating system are you using? Which version?
- Which software applications were running at the time of the problem?
- Can the problem be reproduced? If so, how?

Recording system information

The serial number label is on the bottom of your computer. Record the machine type and the serial number.

- What is the name of your Lenovo product?
- What is the machine type?
- What is the serial number?

Getting help and service

If you need help, service, technical assistance, or more information about Lenovo products, you will find a wide variety of sources available from Lenovo to assist you.

Information about your computer and preinstalled software, if any, is available in the documentation that comes with your computer or on the Lenovo Support Web site at <https://support.lenovo.com>. The documentation includes printed books, online books, readme files, and help files.

Microsoft Service Packs are the latest software source for Windows product updates. They are available through Web download (connection charges might apply) or through discs. For more specific information and links, go to <https://www.microsoft.com>. Lenovo offers technical assistance with installation of, or questions related to, Service Packs for your Lenovo-preinstalled Microsoft Windows product. For more information, contact the Customer Support Center.

Lenovo Support Web site

Technical support information is available on the Lenovo Support Web site at <https://support.lenovo.com>.

This Web site is updated with the latest support information such as the following:

- Drivers and software
- Diagnostic solutions
- Product and service warranty
- Product and parts details
- User guides and manuals
- Knowledge base and frequently asked questions

Calling Lenovo

If you have tried to correct the problem yourself and still need help, during the warranty period, you can get help and information by telephone through the Customer Support Center. The following services are available during the warranty period:

- Problem determination - Trained personnel are available to assist you with determining if you have a hardware problem and deciding what action is necessary to fix the problem.
- Lenovo hardware repair - If the problem is determined to be caused by Lenovo hardware under warranty, trained service personnel are available to provide the applicable level of service.
- Engineering change management - Occasionally, there might be changes that are required after a product has been sold. Lenovo or your reseller, if authorized by Lenovo, will make selected Engineering Changes (ECs) that apply to your hardware available.

The following items are not covered:

- Replacement or use of parts not manufactured for or by Lenovo or nonwarranted parts
- Identification of software problem sources
- Configuration of UEFI BIOS as part of an installation or upgrade
- Changes, modifications, or upgrades to device drivers
- Installation and maintenance of network operating systems (NOS)
- Installation and maintenance of programs

For the terms and conditions of the Lenovo Limited Warranty that apply to your Lenovo hardware product, see “Warranty information” in the *Safety and Warranty Guide* that comes with your computer.

If possible, be near your computer when you make your call. Ensure that you have downloaded the most current drivers and system updates, run diagnostics, and recorded information before you call. When calling for technical assistance, have the following information available:

- Machine type and model
- Serial numbers of your computer, monitor, and other components, or your proof of purchase
- Description of the problem
- Exact wording of any error messages
- Hardware and software configuration information for your system

Telephone numbers

For a list of the Lenovo Support phone numbers for your country or region, go to <https://pcsupport.lenovo.com/supportphonenumberlist> or refer to the *Safety and Warranty Guide* that comes with your computer.

Note: Phone numbers are subject to change without notice. The latest phone numbers are available at <https://pcsupport.lenovo.com/supportphonenumberlist>. If the number for your country or region is not provided, contact your Lenovo reseller or Lenovo marketing representative.

Purchasing additional services

During and after the warranty period, you can purchase additional services. Service availability and service name might vary by country or region.

For more information about these services, go to <https://www.lenovo.com/services>.

Appendix A. Supplemental information about the Ubuntu operating system

In limited countries or regions, Lenovo offers customers an option to order computers with the preinstalled Ubuntu® operating system.

If the Ubuntu operating system is available on your computer, read the following information before you use the computer. Ignore any information related to Windows-based programs, utilities, and Lenovo preinstalled applications in this documentation.

Accessing the Lenovo Limited Warranty

This product is covered by the terms of the Lenovo Limited Warranty (LLW), version L505-0010-02 08/2011. You can view the LLW in a number of languages from the following Web site. Read the Lenovo Limited Warranty at:

https://www.lenovo.com/warranty/llw_02

The LLW also is preinstalled on the computer. To access the LLW, go to the following directory:

```
/usr/share/doc/lenovo-doc
```

If you cannot view the LLW either from the Web site or from your computer, contact your local Lenovo office or reseller to obtain a printed version of the LLW.

Accessing the Ubuntu help system

The Ubuntu help system provides information about how to use the Ubuntu operating system. To access the help system from the Unity, move your pointer to the Launch bar, and then click the **Help** icon. If you cannot find the **Help** icon from the Launch bar, click the **Search** icon, and type Help to search it.

To learn more about the Ubuntu operating system, go to:

<https://www.ubuntu.com>

Getting support information

If you need help, service, technical assistance, or more information about the Ubuntu operating system or other applications, contact the provider of the Ubuntu operating system or the provider of the application. If you need the service and support for hardware components shipped with your computer, contact Lenovo. For more information about how to contact Lenovo, refer to the *User Guide* and *Safety and Warranty Guide*.

To access the latest *User Guide* and *Safety and Warranty Guide*, go to:

<https://support.lenovo.com>

Appendix B. Regulatory information

This chapter provides regulatory and compliance information about Lenovo products.

Certification-related information

Product name: ThinkPad P70

Compliance ID: TP00074A

Machine types: 20ER and 20ES

The latest compliance information is available at:

<https://www.lenovo.com/compliance>

Wireless-related information

This topic provides wireless-related information about Lenovo products.

Wireless interoperability

Wireless-LAN card is designed to be interoperable with any wireless-LAN product that is based on Direct Sequence Spread Spectrum (DSSS), Complementary Code Keying (CCK), and/or Orthogonal Frequency Division Multiplexing (OFDM) radio technology, and is compliant to:

- The 802.11b/g Standard, 802.11a/b/g, 802.11n, or 802.11ac on wireless-LANs, as defined and approved by the Institute of Electrical and Electronics Engineers.
- The Wireless Fidelity (Wi-Fi®) certification as defined by the Wi-Fi Alliance®.

Usage environment and your health

This computer contains integrated wireless cards that operate within the guidelines identified by radio frequency (RF) safety standards and recommendations; therefore, Lenovo believes that this product is safe for use by consumers. These standards and recommendations reflect the consensus of the worldwide scientific community, and result from deliberations of panels and committees of scientists, who continually review and interpret the extensive research literature.

In some situations or environments, the use of wireless devices might be restricted by the proprietor of a building or responsible representatives of an organization. For example, these situations and areas might include the following:

- On board of airplanes, in hospitals or near petrol stations, blasting areas (with electro-explosive devices), medical implants or body-worn electronic medical devices, such as pace makers.
- In any other environment where the risk of interference to other devices or services is perceived or identified as harmful.

If you are uncertain of the policy that applies to the use of wireless devices in a specific area (such as an airport or hospital), you are encouraged to ask for authorization to use a wireless device prior to turning on the computer.

Locating the UltraConnect wireless antennas

ThinkPad notebook computers feature an integrated UltraConnect™ wireless antenna system built into the display for optimal reception, enabling wireless communication wherever you are.

The following illustration shows the antennas locations of your computer:

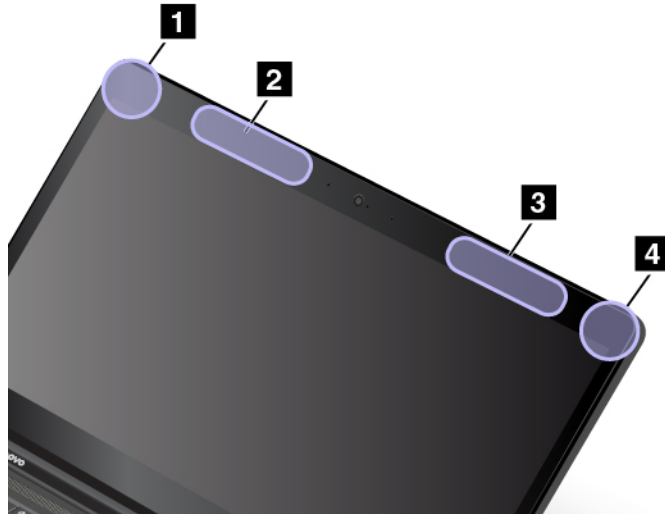

- 1 Wireless-LAN antenna (auxiliary)
- 2 Wireless-WAN antenna (auxiliary, available on some models)
- 3 Wireless-WAN antenna (main, available on some models)
- 4 Wireless-LAN antenna (main)

Wireless-radio compliance information

Computer models equipped with wireless communications comply with the radio frequency and safety standards of any country or region in which it has been approved for wireless use.

Brazil wireless-radio compliance information

Este equipamento não tem direito à proteção contra interferência prejudicial e não pode causar interferência em sistemas devidamente autorizados.

This equipment is not protected against harmful interference and may not cause interference with duly authorized systems.

Mexico wireless-radio compliance information

Advertencia: En Mexico la operación de este equipo está sujeta a las siguientes dos condiciones: (1) es posible que este equipo o dispositivo no cause interferencia perjudicial y (2) este equipo o dispositivo debe aceptar cualquier interferencia, incluyendo la que pueda causar su operación no deseada.

Locating wireless regulatory notices

For more information about the wireless regulatory notices, refer to the *Regulatory Notice* shipped with your computer.

If your computer is shipped without the *Regulatory Notice*, you can find it on the Web site at:

<https://support.lenovo.com>

TCO certification

To obtain the TCO certification information for your computer, go to:

<https://www.lenovo.com/tco-cert>

Export classification notice

This product is subject to the United States Export Administration Regulations (EAR) and has an Export Classification Control Number (ECCN) of 5A992.c. It can be re-exported except to any of the embargoed countries in the EAR E1 country list.

Electromagnetic emission notices

Federal Communications Commission (FCC) Supplier's Declaration of Conformity

The following information refers to ThinkPad P70, machine types: 20ER and 20ES.

This equipment has been tested and found to comply with the limits for a Class B digital device, pursuant to Part 15 of the FCC Rules. These limits are designed to provide reasonable protection against harmful interference in a residential installation. This equipment generates, uses, and can radiate radio frequency energy and, if not installed and used in accordance with the instructions, may cause harmful interference to radio communications. However, there is no guarantee that interference will not occur in a particular installation. If this equipment does cause harmful interference to radio or television reception, which can be determined by turning the equipment off and on, the user is encouraged to try to correct the interference by one or more of the following measures:

- Reorient or relocate the receiving antenna.
- Increase the separation between the equipment and receiver.
- Connect the equipment into an outlet on a circuit different from that to which the receiver is connected.
- Consult an authorized dealer or service representative for help.

Lenovo is not responsible for any radio or television interference caused by using other than recommended cables and connectors or by unauthorized changes or modifications to this equipment. Unauthorized changes or modifications could void the user's authority to operate the equipment.

This device complies with Part 15 of the FCC Rules. Operation is subject to the following two conditions: (1) this device may not cause harmful interference, and (2) this device must accept any interference received, including interference that may cause undesired operation.

Responsible Party:
Lenovo (United States) Incorporated
7001 Development Drive
Morrisville, NC 27560
Email: FCC@lenovo.com



Industry Canada Class B emission compliance statement

CAN ICES-3(B)/NMB-3(B)

European Union conformity

EU Contact: Lenovo, Einsteinova 21, 851 01 Bratislava, Slovakia



EMC Directive Statement: This product is in conformity with the protection requirements of EU Council EMC Directive 2014/30/EU on the approximation of the laws of the Member States relating to electromagnetic compatibility.

This product has been tested and found to comply with the limits for Class B equipment according to European Standards harmonized in the Directives in compliance. The Class B requirements for equipment are intended to offer adequate protection to broadcast services within residential environments.

Radio Equipment Directive Statement: This product is in conformity with all the requirements and essential norms that apply to EU Council R&TTE Directive 1999/5/EC (until June 12, 2017) and Council Radio Equipment Directive 2014/53/EU (from June 13, 2017) on the approximation of the laws of the Member States relating to radio equipment. The full text of the system EU declaration of conformity and the EU wireless module declarations are available at the following Internet addresses:

- For notebook computers: <https://www.lenovo.com/eu-doc-notebooks>
- For tablets: <https://www.lenovo.com/eu-doc-tablets>

Lenovo cannot accept responsibility for any failure to satisfy the protection requirements resulting from a non-recommended modification of the product, including the installation of option cards from other manufacturers. This product has been tested and found to comply with the limits for Class B equipment according to European Standards harmonized in the Directives in compliance. The limits for Class B equipment were derived for typical residential environments to provide reasonable protection against interference with licensed communication devices.

German Class B compliance statement

Hinweis zur Einhaltung der Klasse B zur elektromagnetischen Verträglichkeit

Dieses Produkt entspricht den Schutzanforderungen der EU-Richtlinie zur elektromagnetischen Verträglichkeit Angleichung der Rechtsvorschriften über die elektromagnetische Verträglichkeit in den EU-Mitgliedsstaaten und hält die Grenzwerte der Klasse B der Norm gemäß Richtlinie.

Um dieses sicherzustellen, sind die Geräte wie in den Handbüchern beschrieben zu installieren und zu betreiben. Des Weiteren dürfen auch nur von der Lenovo empfohlene Kabel angeschlossen werden. Lenovo übernimmt keine Verantwortung für die Einhaltung der Schutzanforderungen, wenn das Produkt ohne Zustimmung der Lenovo verändert bzw. wenn Erweiterungskomponenten von Fremdherstellern ohne Empfehlung der Lenovo gesteckt/eingebaut werden.

Zulassungsbescheinigung laut dem Deutschen Gesetz über die elektromagnetische Verträglichkeit von Betriebsmitteln, EMVG vom 20. Juli 2007 (früher Gesetz über die elektromagnetische Verträglichkeit von Geräten), bzw. der EU Richtlinie 2014/30/EU, der EU Richtlinie 2014/53/EU Artikel 3.1b), für Geräte der Klasse B.

Dieses Gerät ist berechtigt, in Übereinstimmung mit dem Deutschen EMVG das EG-Konformitätszeichen - CE - zu führen. Verantwortlich für die Konformitätserklärung nach Paragraf 5 des EMVG ist die Lenovo (Deutschland) GmbH, Meitnerstr. 9, D-70563 Stuttgart.

Japan VCCI Class B compliance statement

この装置は、クラスB機器です。この装置は、住宅環境で使用することを目的としていますが、この装置がラジオやテレビジョン受信機に近接して使用されると、受信障害を引き起こすことがあります。
取扱説明書に従って正しい取り扱いをして下さい。

VCCI-B

Japan compliance statement for products which connect to the power mains with rated current less than or equal to 20 A per phase

日本の定格電流が 20A/相 以下の機器に対する高調波電流規制
高調波電流規格 JIS C 61000-3-2 適合品

Japan notice for ac power cord

The ac power cord shipped with your product can be used only for this specific product. Do not use the ac power cord for other devices.

本製品およびオプションに電源コード・セットが付属する場合は、それぞれ専用のものでありますので他の電気機器には使用しないでください。

Lenovo product service information for Taiwan

委製商/進口商名稱: 荷蘭商聯想股份有限公司台灣分公司
進口商地址: 台北市中山區北安路780號7樓
進口商電話: 0800-000-702 (代表號)

Eurasian compliance mark



Brazil audio notice

Ouvir sons com mais de 85 decibéis por longos períodos pode provocar danos ao sistema auditivo.

Appendix C. WEEE and recycling statements of countries and regions

This chapter provides environmental information about Lenovo products.

General recycling information

Lenovo encourages owners of information technology (IT) equipment to responsibly recycle their equipment when it is no longer needed. Lenovo offers a variety of programs and services to assist equipment owners in recycling their IT products. For information about recycling Lenovo products, go to:

<https://www.lenovo.com/recycling>

The latest environmental information about our products is available at:

<https://www.lenovo.com/ecodeclaration>

Important WEEE information



The WEEE marking on Lenovo products applies to countries with WEEE and e-waste regulations (for example, the European WEEE Directive, India E-Waste Management Rules). Appliances are labeled in accordance with local regulations concerning waste electrical and electronic equipment (WEEE). These regulations determine the framework for the return and recycling of used appliances as applicable within each geography. This label is applied to various products to indicate that the product is not to be thrown away, but rather put in the established collection systems for reclaiming these end of life products.

Users of electrical and electronic equipment (EEE) with the WEEE marking must not dispose of end of life EEE as unsorted municipal waste, but use the collection framework available to them for the return, recycle, and recovery of WEEE and to minimize any potential effects of EEE on the environment and human health due to the presence of hazardous substances. Lenovo electrical and electronic equipment (EEE) may contain parts and components, which at end-of-life might qualify as hazardous waste.

EEE and waste electrical and electronic equipment (WEEE) can be delivered free of charge to the place of sale or any distributor that sells electrical and electronic equipment of the same nature and function as the used EEE or WEEE.

For additional WEEE information, go to:

<https://www.lenovo.com/recycling>

WEEE information for Hungary

Lenovo, as a producer, bears the cost incurred in connection with the fulfillment of Lenovo's obligations under Hungary Law No. 197/2014 (VIII.1.) subsections (1)-(5) of section 12.

Japan recycling statements

Collecting and recycling a disused Lenovo computer or monitor

If you are a company employee and need to dispose of a Lenovo computer or monitor that is the property of the company, you must do so in accordance with the Law for Promotion of Effective Utilization of Resources. Computers and monitors are categorized as industrial waste and should be properly disposed of by an industrial waste disposal contractor certified by a local government. In accordance with the Law for Promotion of Effective Utilization of Resources, Lenovo Japan provides, through its PC Collecting and Recycling Services, for the collecting, reuse, and recycling of disused computers and monitors. For details, visit the Lenovo Web site at:

<https://www.lenovo.com/recycling/japan>

Pursuant to the Law for Promotion of Effective Utilization of Resources, the collecting and recycling of home-used computers and monitors by the manufacturer was begun on October 1, 2003. This service is provided free of charge for home-used computers sold after October 1, 2003. For details, go to:

<https://www.lenovo.com/recycling/japan>

Disposing of Lenovo computer components

Some Lenovo computer products sold in Japan may have components that contain heavy metals or other environmental sensitive substances. To properly dispose of disused components, such as a printed circuit board or drive, use the methods described above for collecting and recycling a disused computer or monitor.

Disposing of disused lithium batteries from Lenovo computers

A button-shaped lithium battery is installed inside your Lenovo computer to provide power to the computer clock while the computer is off or disconnected from the main power source. If you need to replace it with a new one, contact your place of purchase or contact Lenovo for service. If you need to dispose of a disused lithium battery, insulate it with vinyl tape, contact your place of purchase or an industrial-waste-disposal operator, and follow their instructions.

Disposal of a lithium battery must comply with local ordinances and regulations.

Disposing of a disused battery from Lenovo notebook computers

Your Lenovo notebook computer has a lithium ion battery or a nickel metal hydride battery. If you are a company employee who uses a Lenovo notebook computer and need to dispose of a battery, contact the proper person in Lenovo sales, service, or marketing, and follow that person's instructions. You also can refer to the instructions at:

<https://www.lenovo.com/jp/ja/environment/recycle/battery/>

If you use a Lenovo notebook computer at home and need to dispose of a battery, you must comply with local ordinances and regulations. You also can refer to the instructions at:

<https://www.lenovo.com/jp/ja/environment/recycle/battery/>

Recycling information for Brazil

Declarações de Reciclagem no Brasil

Descarte de um Produto Lenovo Fora de Uso

Equipamentos elétricos e eletrônicos não devem ser descartados em lixo comum, mas enviados à pontos de coleta, autorizados pelo fabricante do produto para que sejam encaminhados e processados por empresas especializadas no manuseio de resíduos industriais, devidamente certificadas pelos órgãos ambientais, de acordo com a legislação local.

A Lenovo possui um canal específico para auxiliá-lo no descarte desses produtos. Caso você possua um produto Lenovo em situação de descarte, ligue para o nosso SAC ou encaminhe um e-mail para: reciclar@lenovo.com, informando o modelo, número de série e cidade, a fim de enviarmos as instruções para o correto descarte do seu produto Lenovo.

Battery recycling information for the European Union



Notice: This mark applies only to countries within the European Union (EU).

Batteries or packaging for batteries are labeled in accordance with European Directive 2006/66/EC concerning batteries and accumulators and waste batteries and accumulators. The Directive determines the framework for the return and recycling of used batteries and accumulators as applicable throughout the European Union. This label is applied to various batteries to indicate that the battery is not to be thrown away, but rather reclaimed upon end of life per this Directive.

In accordance with the European Directive 2006/66/EC, batteries and accumulators are labeled to indicate that they are to be collected separately and recycled at end of life. The label on the battery may also include a chemical symbol for the metal concerned in the battery (Pb for lead, Hg for mercury, and Cd for cadmium). Users of batteries and accumulators must not dispose of batteries and accumulators as unsorted municipal waste, but use the collection framework available to customers for the return, recycling, and treatment of batteries and accumulators. Customer participation is important to minimize any potential effects of batteries and accumulators on the environment and human health due to the potential presence of hazardous substances.

Before placing electrical and electronic equipment (EEE) in the waste collection stream or in waste collection facilities, the end user of equipment containing batteries and/or accumulators must remove those batteries and accumulators for separate collection.

Disposing of lithium batteries and battery packs from Lenovo products

A coin-cell type lithium battery might be installed inside your Lenovo product. You can find details about the battery in the product documentation. If the battery needs to be replaced, contact your place of purchase or contact Lenovo for service. If you need to dispose of a lithium battery, insulate it with vinyl tape, contact your place of purchase or a waste-disposal operator, and follow their instructions.

Disposing of battery packs from Lenovo products

Your Lenovo device might contain a lithium-ion battery pack or a nickel metal hydride battery pack. You can find details on the battery pack in the product documentation. If you need to dispose of a battery pack, insulate it with vinyl tape, contact Lenovo sales, service, or your place of purchase, or a waste-disposal operator, and follow their instructions. You also can refer to the instructions provided in the user guide for your product.

For proper collection and treatment, go to:

<https://www.lenovo.com/lenovo/environment>

Battery recycling information for Taiwan



廢電池請回收

Battery recycling information for the United States and Canada



US & Canada Only

Recycling information for China

《废弃电器电子产品回收处理管理条例》提示性说明

联想鼓励拥有联想品牌产品的用户当不再需要此类产品时，遵守国家废弃电器电子产品回收处理相关法律法规，将其交给当地具有国家认可的回收处理资质的厂商进行回收处理。更多回收服务信息，请点击进入<http://support.lenovo.com.cn/activity/551.htm>

Appendix D. Restriction of Hazardous Substances (RoHS) Directive of countries and regions

The latest environmental information about Lenovo products is available at:

<https://www.lenovo.com/ecodeclaration>

European Union RoHS

This Lenovo product, with included parts (cables, cords, and so on) meets the requirements of Directive 2011/65/EU on the restriction of the use of certain hazardous substances in electrical and electronic equipment ("RoHS recast" or "RoHS 2").

For more information about Lenovo worldwide compliance on RoHS, go to:

<https://www.lenovo.com/rohs-communication>

Turkish RoHS

The Lenovo product meets the requirements of the Republic of Turkey Directive on the Restriction of the Use of Certain Hazardous Substances in Waste Electrical and Electronic Equipment (WEEE).

Türkiye AEEE Yönetmeliğine Uygunluk Beyanı

Bu Lenovo ürünü, T.C. Çevre ve Orman Bakanlığı'nın "Atık Elektrik ve Elektronik Eşyalarda Bazı Zararlı Maddelerin Kullanımının Sınırlandırılmasına Dair Yönetmelik (AEEE)" direktiflerine uygundur.

AEEE Yönetmeliğine Uygundur.

Ukraine RoHS

Цим підтверджуємо, що продукція Леново відповідає вимогам нормативних актів України, які обмежують вміст небезпечних речовин

India RoHS

RoHS compliant as per E-Waste (Management) Rules.

China RoHS

The information in the following table is applicable to products manufactured on or after January 1, 2015 for sale in the People's Republic of China.

产品中有害物质的名称及含量

部件名称	铅 (Pb)	汞 (Hg)	镉 (Cd)	六价铬 (Cr (VI))	多溴联苯 (PBB)	多溴二苯醚 (PBDE)
印刷电路板组件	X	○	○	○	○	○
硬盘	X	○	○	○	○	○
光驱	X	○	○	○	○	○
LCD 面板 (LED 背光源)	X	○	○	○	○	○
键盘	X	○	○	○	○	○
内存	X	○	○	○	○	○
电池	X	○	○	○	○	○
电源适配器	X	○	○	○	○	○
底壳、顶盖和扬声器	X	○	○	○	○	○

注：

本表依据SJ/T 11364的规定编制。

○：表示该有害物质在该部件所有均质材料中的含量均在 GB/T 26572标准规定的限量要求以下。

X：表示该有害物质至少在该部件的某一均质材料中的含量超出GB/T 26572标准规定的限量要求。标有“X”的部件，皆因全球技术发展水平限制而无法实现有害物质的替代。印刷电路板组件包括印刷电路板（PCB）及其组件、集成电路（IC）和连接器。某些型号的产品可能不包含上表中的某些部件，请以实际购买机型为准。

图示：



在中华人民共和国境内销售的电子信息产品上将印有“环保使用期限”（EPuP）符号。圆圈中的数字代表产品的正常环保使用期限。

Taiwan RoHS

單元 Unit	限用物質及其化學符號 Restricted substances and its chemical symbols					
	鉛Lead (Pb)	汞Mercury (Hg)	鎘Cadmium (Cd)	六價鉻 Hexavalent chromium (Cr ⁶⁺)	多溴聯苯 Polybrominated biphenyls (PBB)	多溴二苯醚 Polybrominated diphenyl ethers (PBDE)
印刷電路板組件	-	○	○	○	○	○
硬碟機	-	○	○	○	○	○
LCD面板 (LED背光源)	-	○	○	○	○	○
鍵盤	-	○	○	○	○	○
記憶體	-	○	○	○	○	○
電源供應器	-	○	○	○	○	○
底殼、頂蓋和喇叭	-	○	○	○	○	○
麥克風	-	○	○	○	○	○
攝影機	-	○	○	○	○	○
風扇	-	○	○	○	○	○
分離式電源線組	-	○	○	○	○	○
固態硬碟	-	○	○	○	○	○
<p>備考1. “超出0.1 wt %” 及 “超出0.01 wt %” 係指限用物質之百分比含量超出百分比含量基準值。 Note 1: “Exceeding 0.1 wt %” and “exceeding 0.01 wt %” indicate that the percentage content of the restricted substance exceeds the reference percentage value of presence condition.</p> <p>備考2. “○” 係指該項限用物質之百分比含量未超出百分比含量基準值。 Note 2: “○” indicates that the percentage content of the restricted substance does not exceed the percentage of reference value of presence.</p> <p>備考3. “-” 係指該項限用物質為排除項目。 Note 3: The “-” indicates that the restricted substance corresponds to the exemption.</p>						

Appendix E. ENERGY STAR model information



ENERGY STAR® is a joint program of the U.S. Environmental Protection Agency and the U.S. Department of Energy aimed at saving money and protecting the environment through energy efficient products and practices.

Lenovo is proud to offer our customers products with the ENERGY STAR qualified designation. You might find an ENERGY STAR mark affixed on the computer or displayed on the power settings interface. Lenovo computers of the following machine types, if carry an ENERGY STAR mark, have been designed and tested to conform to the ENERGY STAR program requirements for computers.

20ER and 20ES

By using ENERGY STAR qualified products and taking advantage of the power-management features of the computer, you can help reduce the consumption of electricity. Reduced electrical consumption can contribute to potential financial savings, a cleaner environment, and the reduction of greenhouse gas emissions.

For more information about ENERGY STAR, go to:

<https://www.energystar.gov>

Lenovo encourages you to make efficient use of energy an integral part of your day-to-day operations. To help in this endeavor, Lenovo has preset the following power-management features to take effect when the computer has been inactive for a specified length of time:

Power plan: Default (when plugged into ac power)

- Turn off the display: After 10 minutes
- Put the computer to sleep: After 30 minutes

To awaken the computer from sleep mode, press the Fn key on your keyboard. For more information about these settings, see the Windows help information on the computer.

The Wake on LAN function is enabled when your Lenovo computer is shipped from the factory, and the setting remains valid even when the computer is in sleep mode. If you do not need to have Wake on LAN enabled while the computer is in sleep mode, you can reduce the power consumption and prolong the time in sleep mode, by disabling the setting of Wake on LAN for sleep mode.

To disable the setting of Wake on LAN for sleep mode, do the following:

1. Go to Control Panel, and view Control Panel by Category. Click **Hardware and Sound → Device Manager**.
2. In the Device Manager window, expand **Network adapters**.

3. Right-click your network adapter device, and click **Properties**.
4. Click the **Power Management** tab.
5. Clear the **Allow this device to wake the computer** check box.
6. Click **OK**.

Appendix F. Notices

Lenovo may not offer the products, services, or features discussed in this document in all countries. Consult your local Lenovo representative for information on the products and services currently available in your area. Any reference to a Lenovo product, program, or service is not intended to state or imply that only that Lenovo product, program, or service may be used. Any functionally equivalent product, program, or service that does not infringe any Lenovo intellectual property right may be used instead. However, it is the user's responsibility to evaluate and verify the operation of any other product, program, or service.

Lenovo may have patents or pending patent programs covering subject matter described in this document. The furnishing of this document does not give you any license to these patents. You can send license inquiries, in writing, to:

*Lenovo (United States), Inc.
1009 Think Place - Building One
Morrisville, NC 27560
U.S.A.
Attention: Lenovo Director of Licensing*

LENOVO PROVIDES THIS PUBLICATION "AS IS" WITHOUT WARRANTY OF ANY KIND, EITHER EXPRESS OR IMPLIED, INCLUDING, BUT NOT LIMITED TO, THE IMPLIED WARRANTIES OF NON-INFRINGEMENT, MERCHANTABILITY OR FITNESS FOR A PARTICULAR PURPOSE. Some jurisdictions do not allow disclaimer of express or implied warranties in certain transactions, therefore, this statement may not apply to you.

This information could include technical inaccuracies or typographical errors. Changes are periodically made to the information herein; these changes will be incorporated in new editions of the publication. Lenovo may make improvements and/or changes in the product(s) and/or the application(s) described in this publication at any time without notice.

The products described in this document are not intended for use in implantation or other life support applications where malfunction may result in injury or death to persons. The information contained in this document does not affect or change Lenovo product specifications or warranties. Nothing in this document shall operate as an express or implied license or indemnity under the intellectual property rights of Lenovo or third parties. All information contained in this document was obtained in specific environments and is presented as an illustration. The result obtained in other operating environments may vary.

Lenovo may use or distribute any of the information you supply in any way it believes appropriate without incurring any obligation to you.

Any references in this publication to non-Lenovo Web sites are provided for convenience only and do not in any manner serve as an endorsement of those Web sites. The materials at those Web sites are not part of the materials for this Lenovo product, and use of those Web sites is at your own risk.

Any performance data contained herein was determined in a controlled environment. Therefore, the result obtained in other operating environments may vary significantly. Some measurements may have been made on development-level systems and there is no guarantee that these measurements will be the same on generally available systems. Furthermore, some measurements may have been estimated through extrapolation. Actual results may vary. Users of this document should verify the applicable data for their specific environment.

This document is copyrighted by Lenovo and is not covered by any open source license, including any Linux agreement(s) which may accompany software included with this product. Lenovo may update this document at any time without notice.

To obtain the most up-to-date documentation for your computer, go to:

<https://support.lenovo.com>

Appendix G. Trademarks

The following terms are trademarks of Lenovo in the United States, other countries, or both:

- Access Connections
- Active Protection System
- Lenovo
- Rescue and Recovery
- Secure Data Disposal
- the ThinkPad logo
- ThinkPad
- TrackPoint
- Ultrabay
- UltraConnect

Intel, Intel SpeedStep, and Thunderbolt are trademarks of Intel Corporation or its subsidiaries in the U.S. and/or other countries.

Microsoft, Windows, Direct3D, BitLocker, and Cortana are trademarks of the Microsoft group of companies.

Mini DisplayPort (mDP) and DisplayPort are trademarks of the Video Electronics Standards Association.

Ubuntu is a registered trademark of Canonical Ltd.

The terms HDMI and HDMI High-Definition Multimedia Interface are trademarks or registered trademarks of HDMI Licensing LLC in the United States and other countries.

Other company, product, and service names may be trademarks or service marks of others.

Lenovo