



IBM

IBM ThinkPad 770 User's Guide



Note

Before using this information and the product it supports, be sure to read the general information in "Safety Information" on page vii, Appendix C, and Appendix E.

First Edition (September 1997)

The following paragraph does not apply to the United Kingdom or any country where such provisions are inconsistent with local law:

INTERNATIONAL BUSINESS MACHINES CORPORATION PROVIDES THIS PUBLICATION "AS IS" WITHOUT ANY WARRANTY OF ANY KIND, EITHER EXPRESS OR IMPLIED, INCLUDING, BUT NOT LIMITED TO, THE LIMITED WARRANTIES OF MERCHANTABILITY OR FITNESS FOR A PARTICULAR PURPOSE. Some states do not allow disclaimers or express or implied warranties in certain transactions; therefore, this statement may not apply to you.

This publication could include technical inaccuracies or typographical errors. Changes are periodically made to the information herein; these changes will be incorporated in new editions of the publication. IBM may make improvements or changes in the products or the programs described in this publication at any time.

Requests for technical information about IBM products should be made to your IBM authorized dealer or your IBM marketing representative.

Copyright International Business Machines Corporation 1997. All rights reserved. Note to U.S. Government Users – Documentation related to restricted rights – Use, duplication, or disclosure is subject to restrictions set forth in GSA ADP Schedule Contract with IBM Corp.

Contents

Safety Information	vii
Laser Compliance Statement	ix
Chapter 1. Getting to Know Your Computer	1-1
Knowing the Indicators on the LCD Indicator Panel	1-7
Using the Fn Key Function	1-9
Using the Numeric Keypad	1-11
Knowing the LED Color Indications	1-12
Functional Highlights	1-13
DVD	1-13
Audio	1-13
Audio with 3D Stereo Sound	1-13
Video Capture	1-13
Infrared	1-14
Video Phone Features	1-14
System Management Features	1-14
TrackPoint with Enhanced Controls	1-14
Chapter 2. Fine-Tuning Your Computer	2-1
Starting the ThinkPad Configuration Program	2-3
ThinkPad Configuration Program for Windows 95	2-3
ThinkPad Configuration Program for Windows NT	2-4
ThinkPad Configuration for DOS	2-5
Switching Screens	2-7
Switching between the External Display and Television	2-7
Using the TrackPoint	2-9
Operating the TrackPoint	2-9
Cleaning the Cap	2-10
Customizing the TrackPoint	2-10
Using the ThinkPad Online Book	2-15
Using the Security Features	2-16
Using Passwords	2-16
Using the Personalization Editor	2-24
Saving Battery Power	2-26
Using the Power Management Modes	2-26
Using Other Battery Saving Methods	2-30
Checking the Battery Status	2-31
Using the Fuel Program	2-32
Using the Audio Features	2-35
Using the 3D Sound Retrieval System (SRS) Function	2-36

Using the MIDI Features	2-37
Using the ThinkPad Modem	2-39
Using the ThinkPad Modem in Windows 95 and Windows NT	2-41
Using the ThinkPad Modem in OS/2	2-41
Using the 56 Kbps Modem	2-41
Telephony Features	2-43
Using the DVD and Enhanced Video Adapter	2-44
Using the DVD Enhanced Video Adapter with Windows 95	2-45
Using the Enhanced Video Features in OS/2	2-51
Using Easy-Setup	2-54
Knowing Your Configuration	2-56
Setting the Date and Time	2-57
Changing the Drive Startup Sequence	2-57
Chapter 3. Installing Options	3-1
Installing IBM Options	3-2
Installing a Memory Option	3-2
Replacing the Hard Disk Drive in the HDD Bay	3-5
Installing the Battery Pack	3-6
Removing and Installing a Device in UltraBay II	3-7
Installing the DVD and Enhanced Video Adapter	3-10
Replacing the Backup Battery	3-11
Attaching a Mouse, a Numeric Keypad, or an External Keyboard	3-13
Inserting or Removing a PC Card	3-15
Installing Other Devices	3-17
Using a Docking Station	3-17
Using the Security System Lock	3-21
Attaching a Television to Your Computer	3-22
Chapter 4. Solving Computer Problems	4-1
Frequently Asked Questions	4-2
Troubleshooting Guide	4-3
Troubleshooting Charts	4-4
Error Codes or Screen Messages	4-5
No Error Codes or Screen Messages	4-10
An Input Problem	4-11
A Suspend or Hibernation Problem	4-12
An LCD Problem	4-16

An Indicator Problem	4-17
A Battery Problem	4-17
A CD-ROM Drive Problem	4-18
A DVD Problem	4-20
An Infrared Communication Problem	4-21
An Enhanced Video/MPEG Problem	4-22
An Audio or a Telephony Problem	4-22
A Universal Serial Bus (USB) Problem	4-23
A Modem Problem	4-23
Other PC Card Problems	4-26
A SelectaDock Problem	4-26
A Printer Problem	4-27
An External Display Problem	4-27
A Television Problem	4-29
Other Option Problems	4-29
A Software Problem	4-31
Other Problems	4-31
Testing Your Computer	4-32
Chapter 5. Getting Service	5-1
Information on Your ThinkPad	5-2
Option List	5-2
Identification Numbers	5-2
Problem Recording Sheet	5-3
How to Receive Customer Support and Service	5-4
Help by Telephone	5-4
ThinkPad EasyServ	5-5
Getting Help around the World	5-5
Online Housecall	5-6
Fax Information	5-6
Electronic Support Services	5-6
Purchasing Additional Services	5-8
Enhanced PC Support Line	5-8
Network and Server Support Line	5-8
Ordering Support Line Services	5-9
Warranty and Repair Services	5-10
Obtaining IBM Operating System Updates	5-11
Getting Update Diskettes	5-11
Ordering Publications	5-11
About Your Warranty	5-11

Appendix A. Operating Requirements	A-1
Specifications	A-2
Operating Environment	A-3
Power Cord Requirements	A-5
For 2-Pin Power Cords	A-5
For 3-Pin Power Cords	A-6
Appendix B. Installing a New Operating System	B-1
Appendix C. Ergonomics Information	C-1
Appendix D. Product Warranty	D-1
Appendix E. Notices	E-1
Trademarks	E-1
Electronic Emission Notice	E-2
Federal Communications Commission (FCC) Statement	E-2
Canadian Department of Communications Compliance Statement	E-2
Avis de conformité aux normes du ministère des Communications du Canada	E-3
European Community Directive Conformance Statement	E-3
Telecommunication Notice	E-4
Industry Canada Requirements	E-6
Notice	E-6
Caution	E-6
Notice	E-7
Avis	E-7
Avertissement	E-8
Index	X-1

Safety Information



Danger:

Electrical current from power, telephone, and communication cable is hazardous. To avoid shock hazard, connect and disconnect cables as shown below when installing, moving, or opening the covers of this product or attached devices. The 3-pin power cord must be used with a properly grounded outlet.

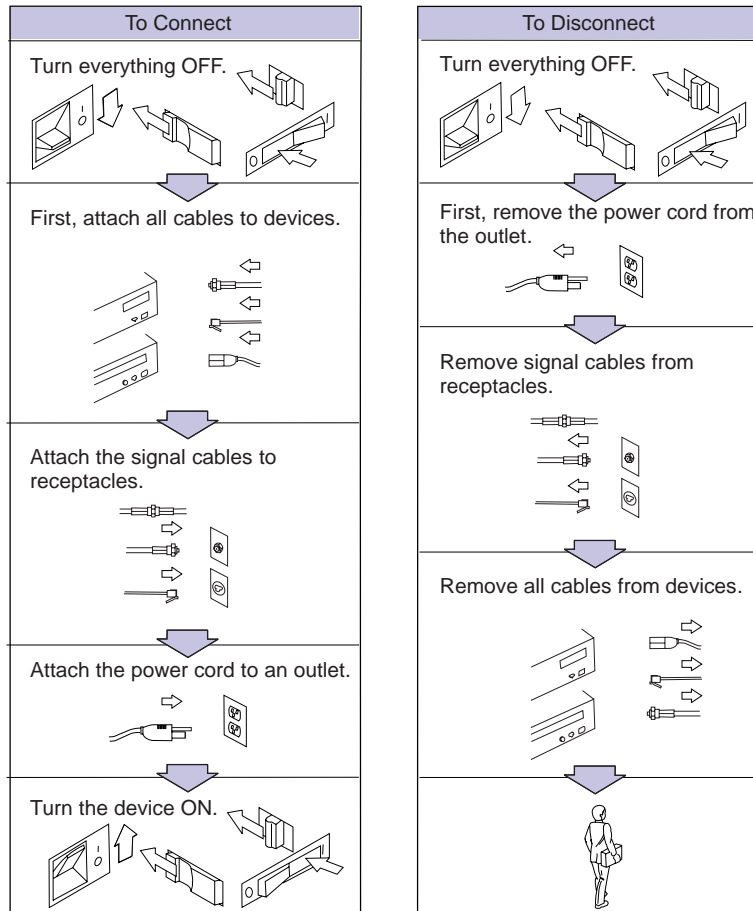

In the U.K., by law:

The telephone line cable must be connected after the power cord.

The power cord must be disconnected after the telephone line cable.

 **Danger:**

Do not disassemble, incinerate, or short-circuit the rechargeable battery pack. Do not put it in trash that is disposed of in landfills. Dispose of it as required by local ordinances or regulations. In the United States, call IBM at 1-800-IBM-4333 for information on disposal.

 **Caution:**

The fluorescent lamp in the liquid crystal display (LCD) contains mercury. Do not put it in trash that is disposed of in landfills. Dispose of it as required by local ordinances or regulations.

The LCD is made of glass, and rough handling or dropping the computer can cause the LCD to break. If the LCD breaks and the internal fluid gets into your eyes or on your hands, immediately wash the affected areas with water for at least 15 minutes; then get medical care if any symptoms are present after washing.

Laser Compliance Statement

The optional CD-ROM and DVD drives in the IBM ThinkPad 770 are laser products. The drives' classification label (shown below) are located on the top of these drives.

CLASS 1 LASER PRODUCT
LASER KLASSE 1
LUOKAN 1 LASERLAITE
APPAREIL A LASER DE CLASSE 1
KLASS 1 LASER APPARAT

The CD-ROM and DVD drives are certified in the U.S. to conform to the requirements of the Department of Health and Human Services 21 Code of Federal Regulations (DHHS 21 CFR) Subchapter J for Class I laser products.

In other countries, the drives are certified to conform to the requirements of EN60825.



Do not open the CD-ROM or DVD drive; no user adjustments or serviceable parts are inside.

Use of controls, adjustments, or the performance of procedures other than those specified may result in hazardous radiation exposure.

Class I (1) laser products are not considered to be hazardous. The CD-ROM and DVD drives have an internal, Class I (1), 0.5-milliwatt, aluminum gallium-arsenide laser that operates at a wavelength of 760 to 810 nanometers. The design of the laser system and the CD-ROM and DVD drives ensure that there are no exposure to laser radiation above a Class I (1) level during normal operation, user maintenance, or servicing conditions.



x



Chapter 1. Getting to Know Your Computer

Thank you for purchasing the IBM ThinkPad Computer. The ThinkPad 770 series of computers incorporates the latest in hardware technology. The high-end models have a larger screen than the low-end models and are equipped with an internal modem. A digital versatile disk is available as an option for playing off-the-shelf DVD titles and movies.



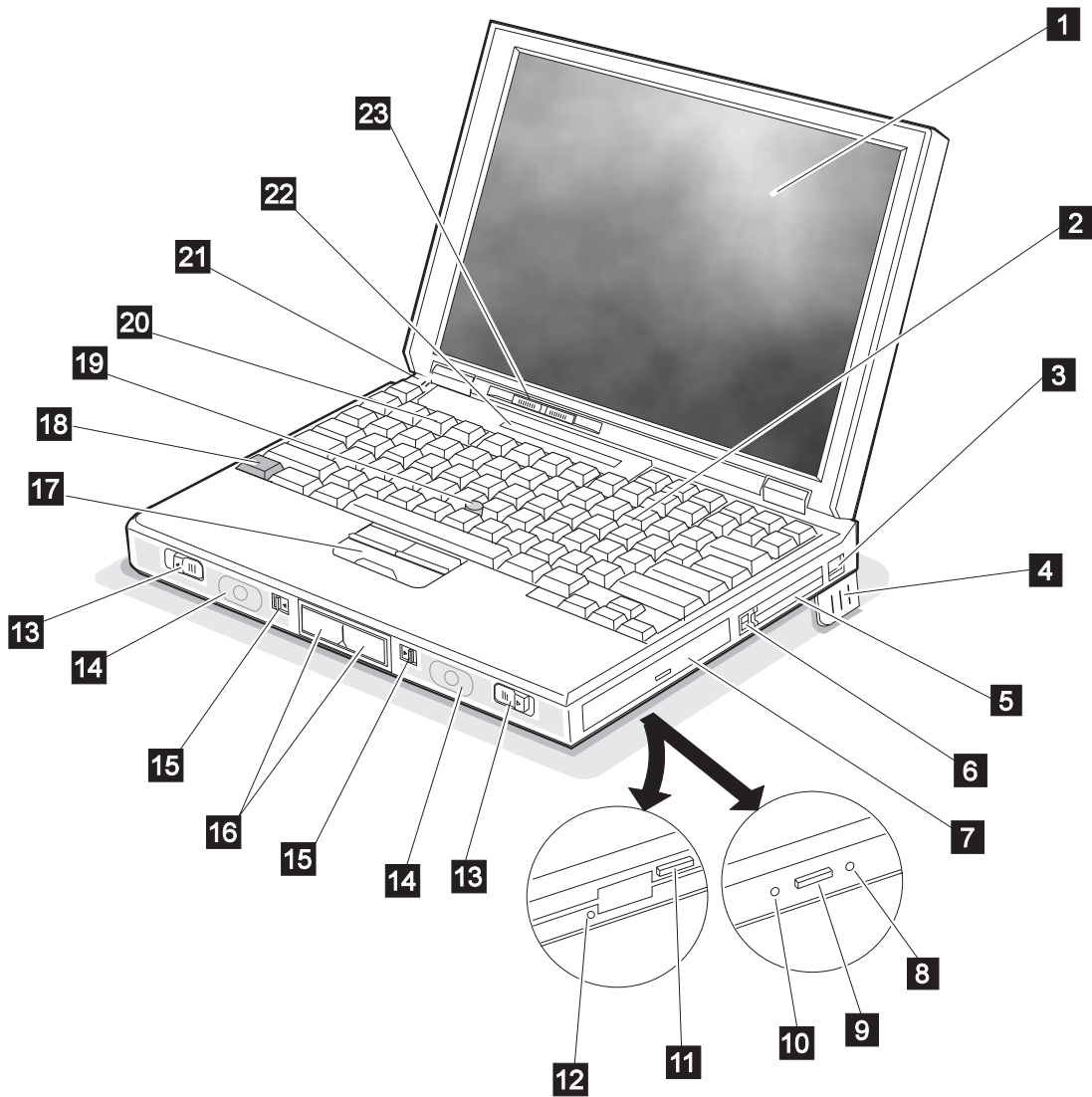

You can use this book to find out how to use the various software bundled with your computer and also about the hardware features. You can also refer to the online book which is in your hard disk, to find out on more technical matters. See "Using the ThinkPad Online Book" on page 2-15 for details.

Knowing the Indicators on the LCD Indicator Panel	1-7
Using the Fn Key Function	1-9
Using the Numeric Keypad	1-11
Knowing the LED Color Indications	1-12
Functional Highlights	1-13
DVD	1-13
Audio	1-13
Audio with 3D Stereo Sound	1-13
Video Capture	1-13
Infrared	1-14
Video Phone Features	1-14
System Management Features	1-14
TrackPoint with Enhanced Controls	1-14



- 1 The **liquid crystal display (LCD)** displays text and graphics on the computer screen.
- 2 The **numeric keypad** is used for typing numbers in **NumLk** mode.

- 3  The **internal modem port** (also called the **telephone jack**), equipped on some models, is used for connecting your computer to a telephone line.



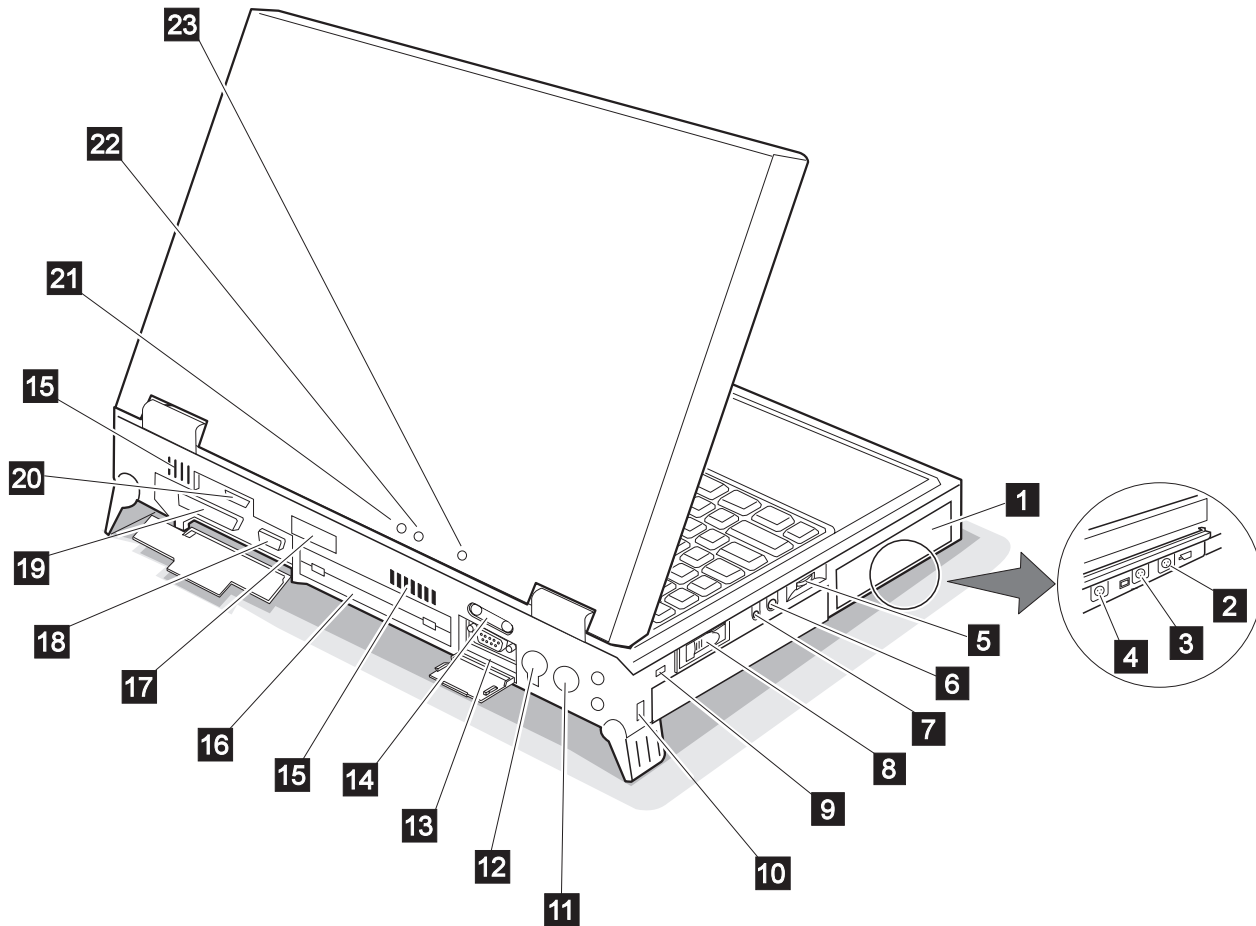















- 4 The **legs** can be extended to angle the keyboard for more comfortable typing.
- 5  The **PC Card slots** support the following type of PC cards: PCMCIA (Type I, Type II, and Type III), CardBus, and Zoomed Video (ZV) card. The **eject buttons**  eject the PC cards from the slots.
- 7 The **UltraBay II** is used for inserting various devices such as a CD-ROM drive, diskette drive, DVD drive, a secondary hard disk drive, and a secondary battery pack.
- 8 The **emergency eject hole** is used to eject the optional DVD or CD-ROM tray when it does not open with the eject button . Insert a pin to eject the tray.
- 9 The **eject button** ejects the tray from the optional CD-ROM or DVD drive.
- 1 The **drive-in-use lamp** goes on when data is being read from a CD-ROM or a DVD disc in the optional CD-ROM or DVD drive. Do not enter suspend mode or eject a disc when this lamp is on.
- 11 The **diskette eject button** ejects a diskette from the diskette drive.
- 12 The **diskette drive-in-use lamp** goes on when data is being written to or is being read from a diskette. Do not enter suspend mode or eject a diskette when this lamp is on.
- 13 The left and right **cover release latches** release the cover for operation.
- 14 The left and right **internal speakers** generate stereo sound.
- 15 The left and right **release latches** release the left and right **bay eject levers**  which release any device in the battery bay or the UltraBay II, respectively. The right release latch contains an **LED** that indicates when you can safely remove a device from the UltraBay II. See page 1-12 for details of the lamp color indications.
- 17 The **left click**, **right click**, and **center click buttons** are used to select items on the screen, double-click and bring up context menus. They work like mouse click buttons. The center click button (below the other buttons) is used to activate the enhanced TrackPoint functions. See page 2-9.
- 18 Press the **Fn key** with certain function keys (F1–F12) to activate special ThinkPad functions (shown with blue-gray icons on the function keys). See page 1-9.
- 19 The **TrackPoint** is a built-in pointing stick that functions like a mouse. It also has enhanced features that a mouse does not have. See page 2-9.
- 2 The **function keys** are used for activating various functions.
- 21 The **built-in microphone** is used for sound recording and telephony.
- 22 The **LCD indicator panel** shows the current status of the computer and battery power with indicators and numeric information. See page 1-7.
- 23  The **brightness control lever** adjusts the brightness of the screen.



1 The **battery pack** is a built-in power source for the computer. It allows you to operate the computer when ac power is not available.

2  The **video-in port** is used for connecting such devices as the VCR and video camera to receive video images.



- 3  The **video-out port** is used for connecting your computer to a television or a VCR to send video images to these devices.
- 4 Reserved.
- 5  The **volume control** adjusts the sound level of the built-in speakers.
- 6  The **microphone/line-in jack** is where you connect a stereo microphone or external audio device.
- 7  The **headphone jack** is where you connect a stereo headphone or external speakers.
- 8  The **power switch** turns the computer on and off.
- 9  The **reset switch** resets the system in an emergency.
- 10  The **security keyhole** is used with a security lock. See page 3-21.
- 11  The **AC power jack** is where you connect the AC Adapter cable.
- 12  The **external-input-device port** allows you to attach a mouse, an external keyboard, or an external numeric keypad.
- 13  The **serial port** (9-pin) is where you connect a serial-device cable.
- 14  The **universal serial bus (USB)** allows you to connect any device that conforms to this new interface. Many recent digital devices comply to this new standard.
- 15 The **fan louvers** are for circulating air within the computer. *Do not place any object in front of these louvers.*
- 16  The **system-expansion port** (240-pin) allows you to connect the IBM ThinkPad SelectaBase 770 port replicator.
- 17  The **rear infrared port** allows your computer to communicate with other devices that have infrared data-transfer capabilities.
- 18  The **external-display port** (15-pin) is where you attach an external display.
- 19  The **parallel port** (25-pin) is where you usually connect a parallel-printer signal cable.
- 20  The **external-diskette-drive port** is where you attach an external-diskette-drive.
- 21  The **power-on lamp** indicates that the computer power is on, regardless of whether the computer is in suspend mode.
- 22  The **suspend lamp** indicates that the computer is in suspend mode.
Green: The computer is in suspend mode.
Blinking green: The computer is in the process of changing modes.
- 23  The **charge lamp** shows the charge status of your battery.
Green: Enough battery power is left for operation.
Orange: The battery pack is being charged.
Blinking orange: The battery pack needs to be charged.
- You will hear three beeps the moment this lamp starts blinking if you had set the alarm in the ThinkPad Configuration program.

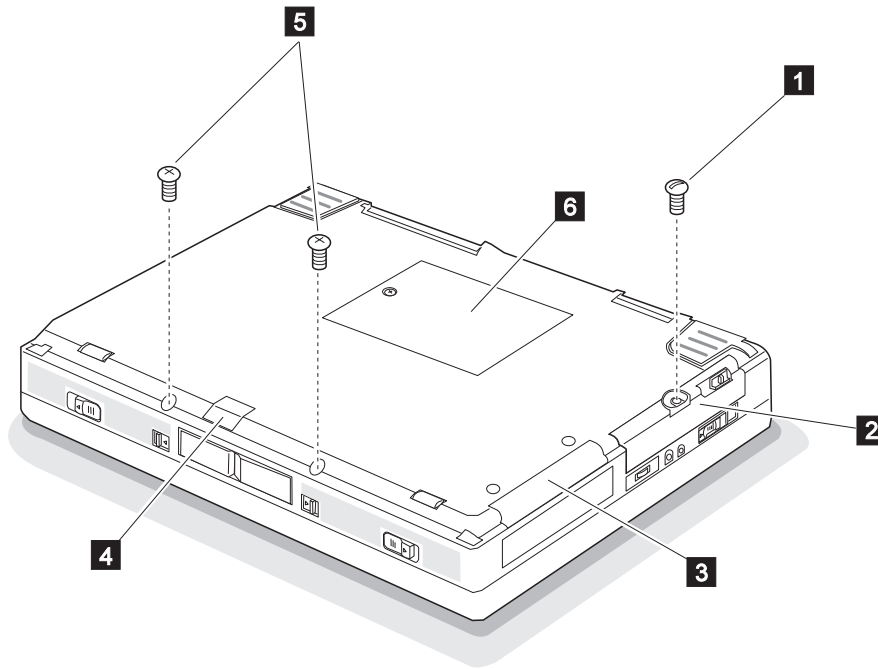



- 1 The **coin screw** can be changed to a normal screw shipped with your computer to prevent others from gaining access to the hard disk in the hard disk bay.
- 2 The **hard disk bay** houses the replaceable hard disk drive.
- 3 The **adapter bay** is a slot for installing the *DVD and Enhanced Video Adapter*, a standard feature on some models.
- 4 **)))** The **front infrared port** allows your computer to communicate with other devices that have infrared data-transfer capabilities.
- 5 The **security screws** are normal screws that can be installed to prevent others from releasing the left and right **release latches** and easily gaining access to the battery bay and the UltraBay II.
- 6 The **bottom compartment** houses the DIMM memory slots and the backup battery slot. You can insert up to two DIMM memory cards into the memory slots to upgrade your system memory. The backup battery in the battery slot is used for retaining computer information in computer memory and also for running the time-of-day clock.

Knowing the Indicators on the LCD Indicator Panel

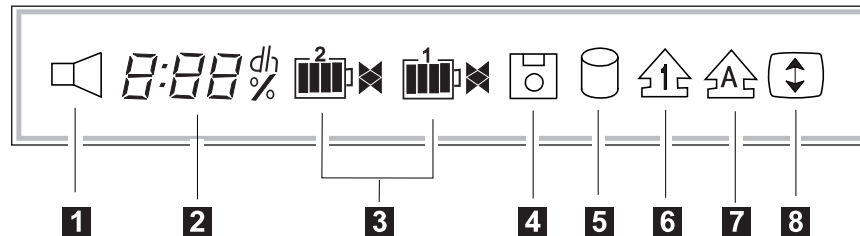
Various indicators appear on the LCD indicator panel. These indicators show the operating conditions of your computer. You will be able to use your computer more efficiently if you know what these indicators mean.



- 1 The **speaker** indicator appears when the speaker beeps. It turns off when a key is pressed.
- 2 The **remaining battery** indicator shows the remaining battery power in either percent (%), days (*d*), hours (*h*), or hours and minutes (*hh:mm*).

When a secondary battery is used, the indicator shows the average percentage of the main battery and the secondary battery combined.
- 3 The **battery status** indicator shows the status of the main battery pack **1** (in the battery bay) and the secondary battery pack **2** (in the UltraBay II) in five levels, from empty  to full .



The indicator on the right shows the battery charge status; charging (◀) and discharging (▶). A blank indicates no battery activity.





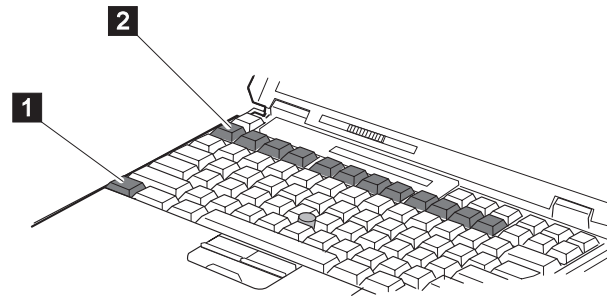









- 4 The **diskette drive in-use** indicator appears when data is being read from or is being written to a diskette.
Do not enter suspend mode or eject the diskette when this indicator is being displayed.
- 5 The **hard disk in-use** indicator appears when data is being read from or is being written to the hard disk.
Do not enter suspend mode or turn off the computer when this indicator is being displayed.
- 6 The **numeric lock** indicator indicates that the numeric keypad function is enabled. Press and hold the **Shift** key while pressing the **NumLk** key to enable or disable this function.
- 7 The **caps lock** indicator indicates that the caps lock mode is enabled. This mode enables you to enter the alphabet characters (A–Z) in capital letters without using the **Shift** key. The **Caps Lock** key enables and disables this mode.
- 8 The **scroll lock** indicator indicates that the scroll lock function is enabled. This function enables you to use the **Arrow** keys to scroll the screen. However, you will not be able to move the cursor with these keys when this function is enabled. The **ScrLk** key enables and disables this function. Not all application programs support this function.

Using the Fn Key Function

The **Fn** key allows you to change the operating conditions of your computer instantly. To use the ThinkPad functions, press and hold the **Fn** key **1** ; then press the appropriate function key **2** (**F1** to **F12**).



Key Combination	Keytop	Function
Fn + F1	—	Unused
Fn + F2		Displays the battery power status indicator or erases it when it is being displayed. The Fuel program must be activated before you can use this function. See page 2-32.
Fn + F3		Places the computer in standby mode. See page 2-26.
Fn + F4		Places the computer in suspend mode. See page 2-26.
Fn + F5	—	Unused
Fn + F6	—	Unused

Key Combination	Keytop	Function
 + 		<p>Switches the computer display in the following sequence when an external display is attached.</p> <p style="text-align: center;">External Both Display LCD</p>
 + 	—	Switches the LCD mode between expanded and shrunk mode. You should expand the LCD screen as much as possible in expanded mode. If you are displaying in full colors, your display area will be smaller even in expanded mode.
 + 	—	Unused
 + 	—	Unused
 + 		<p>Switches the power mode in the following sequence:</p> <p style="text-align: center;">High Auto Customized</p>
 + 		Places the computer in hibernation mode. See page 2-26.

Using the Numeric Keypad

You can use a group of keys on the keyboard as numeric keys. There are numbers engraved in the lower right corner of these keys. To enable this function, press and hold the **Shift** key and then press the **NumLk** key. The **NumLK** icon () appears on the LCD indicator panel.

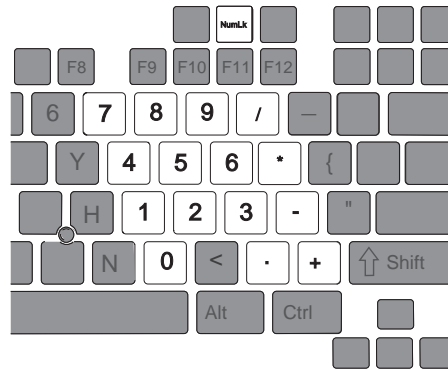

Once you enable this function, you can also use the following keys for cursor-control and screen-control by pressing and holding the **Shift** key.

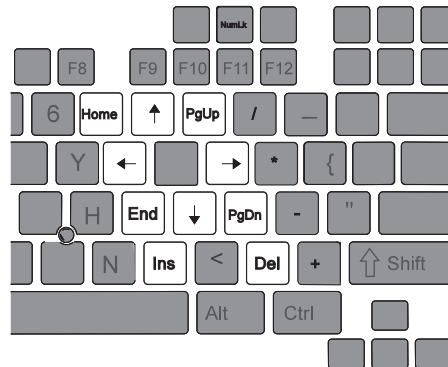

To disable the numeric keypad function, press and hold the **Shift** key; then press **NumLk** again.

Note: You **cannot** use the numeric keypad function when you are using an external numeric keypad or an external keyboard.

Knowing the LED Color Indications

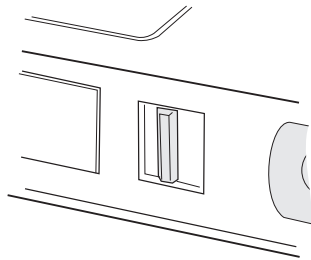

The ThinkPad computer enables you to attach or detach devices dynamically (*hot or warm plugging and unplugging*) in the UltraBay II.

Hot plug or unplug means to attach or detach a device while the computer is operating.

Warm plug or unplug means to attach or detach a device while the computer is in suspend mode.

Cold plug or unplug means to attach or detach a device while the computer is powered off. Your computer supports cold plugging and unplugging for all devices.

See the *User's Guide Supplement* for a list of devices that support this function.

The LED at the front of your computer and a beep indicates the following conditions of the UltraBay II:

Color	Action	Sound
Green	Ready to remove a device from or install a device in the UltraBay II.	No beep
Blinking green	Removal or installation in-process. Wait.	No beep
Black (off)	A device is operating normally in the UltraBay II or there is no device in the UltraBay II.	No beep
Blinking yellow	<p>A device (such as a hard disk drive) is about to be removed and the <i>hot</i> and <i>warm unplugging</i> function is not supported. Do not remove the device. Push back the bay eject lever.</p> <p>A device (such as a hard disk drive) is about to be installed and the <i>hot</i> and <i>warm plugging</i> function is not supported. Do not install the device. Push back the bay eject lever, power off your computer; then reinstall the device.</p>	A short beep followed by a continuous beep
Yellow	A device that was not supposed to be removed (such as a hard disk drive) was removed. The computer may be damaged.	A long beep

Functional Highlights

This section summarizes the major functions of your computer. These functions are offered as standard on some models and as options on others.

DVD

The digital versatile disk (DVD) drive can play standard CD-ROM discs. When used with the DVD and Enhanced Video Adapter, it can play business presentations recorded in DVD format or play off-the-shelf DVD titles and movies.

Audio

The audio feature supports the following:

- Wave audio recording and playback of up to 16 bits, stereo, and 44 KHz sampling.

- DOS games using the Sound Blaster** interface.

A model equipped with the IBM Advanced Communications Processor provides a high-quality MIDI wave table synthesizer with 128 instruments and up to 32 voices.

Audio with 3D Stereo Sound

Your computer is equipped with internal audio record and playback capabilities including 3D audio from just two speakers. When 3D stereo sound is enabled, sounds will appear to be generated all around you, even though only two speakers are used.

The ThinkPad 770 features a high-quality MIDI wave table synthesizer with 128 instruments and up to 32 voices, plus support for DOS Sound Blaster games.

Video Capture

The DVD and Enhanced Video Adapter provides for the capture of still and motion video from an analog source such as a VCR and TV. The ThinkPad 770 includes the Digital Video Producer application for editing and compressing the video.

Infrared

Infrared technology makes wireless communication possible between infrared-enabled devices. Your computer has two infrared ports. Each port can be aimed for point-to-point communication with a portable computer, printer, or other infrared-enabled device. Each port can communicate at a distance of up to approximately 1 m (3.3 ft.) at a rate of up to 4 megabits per second (Mbps).

Video Phone Features

The Intel Video Phone** feature lets you use your computer like a telephone. It lets you see the person you are talking to in a window after you've made a call with your computer's call center. This program also lets you send such files as documents or spreadsheets, or play games with the person you are talking to. You can use either a regular telephone line or the Internet to make calls. Regular phone lines produce better audio and video quality. However, long distance calls over the Internet might save money, since you pay only for the local call. You can use this function only in receive mode if you don't have a camera; that is, you can see your caller, but he or she can't see you. To enable send mode so that the caller can see you, you must purchase an upgrade kit from Intel. This kit comes with a camera.

System Management Features

Your computer has features that enable a network administrator to control it remotely over a network from a management console. If your computer is connected to a SelectaDock III docking station with an IBM 100/10 Ethernet PCI Adapter with Wake on LAN and an IBM Auto Wake Token Ring ISA Adapter installed, the Wake-on-LAN capability is also supported.

TrackPoint with Enhanced Controls

Your computer has an enhanced TrackPoint function that enables you to make selections merely by pressing on the TrackPoint. A new center button converts the TrackPoint into a scroll controlling device or a magnifying glass on the screen.

Chapter 2. Fine-Tuning Your Computer

This chapter describes how to use the following features of your ThinkPad computer:

Starting the ThinkPad Configuration Program	2-3
ThinkPad Configuration Program for Windows 95	2-3
ThinkPad Configuration Program for Windows NT	2-4
ThinkPad Configuration for DOS	2-5
Switching Screens	2-7
Switching between the External Display and Television	2-7
Using the TrackPoint	2-9
Operating the TrackPoint	2-9
Cleaning the Cap	2-10
Customizing the TrackPoint	2-10
Using the ThinkPad Online Book	2-15
Using the Security Features	2-16
Using Passwords	2-16
Setting a Password	2-16
Changing or Removing a Password Using Easy-Setup	2-19
Entering a Password	2-22
Using the Supervisor Password on Several Hard Disk Drives	2-23
Using the Personalization Editor	2-24
Saving Battery Power	2-26
Using the Power Management Modes	2-26
Setting the Suspend Timer	2-27
Enabling Hibernation Mode	2-28
Using Other Battery Saving Methods	2-30
Checking the Battery Status	2-31
Using the Fuel Program	2-32
Changing the Battery Status Indication	2-34
Using the Audio Features	2-35
Using the 3D Sound Retrieval System (SRS) Function	2-36
Using the MIDI Features	2-37
Using the ThinkPad Modem	2-39
Using the ThinkPad Modem in Windows 95 and Windows NT	2-41
Using the ThinkPad Modem in OS/2	2-41
Using the 56 Kbps Modem	2-41
Telephony Features	2-43
Using the DVD and Enhanced Video Adapter	2-44

Using the DVD Enhanced Video Adapter with Windows 95	2-45
Using the Capture Function	2-45
Using the Overlay Function	2-47
Using the MPEG Playback	2-49
Using the DVD Player	2-50
Using the Enhanced Video Features in OS/2	2-51
Using Easy-Setup	2-54
Knowing Your Configuration	2-56
Setting the Date and Time	2-57
Changing the Drive Startup Sequence	2-57

Starting the ThinkPad Configuration Program

This section describes how to start the ThinkPad Configuration program. This program allows you to set up and customize the computer's built-in devices to your needs.

ThinkPad Configuration Program for Windows 95

To start the **ThinkPad Configuration** program for Windows 95, click on **Start**, select **Programs** and **ThinkPad**, and double-click on **ThinkPad Configuration**. The following window appears:

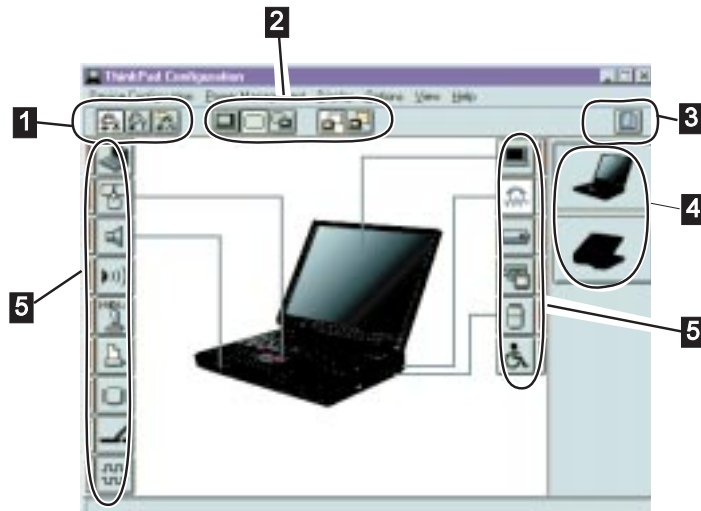

- 1 The **Power Mode** buttons
Click on one of these buttons to set the power mode to high performance mode, automatic mode, or customized mode.
- 2 The **Display Device** buttons
Click on one of these buttons to set the display output type to the LCD, external display, or to both. When making a presentation, you can click on the presentation button to disable any system timers, such as the LCD turn-off timer or the power-save mode timers.
- 3 The **Help** button displays the online help.

- 4 The **View Angle** buttons
Click on the front view or rear view buttons to display the hardware feature locations.
- 5 The **Device** buttons
Click on the button of your choice from the window.
When the device is enabled, the red indicator next to the button is lit. Otherwise, it stays off.

Only the top portion of the window is displayed when you click on the triangular minimize button in the top-right corner.

ThinkPad Configuration Program for Windows NT

To start the **ThinkPad Configuration** program for Windows NT, click on **Start**, select **Programs** and **ThinkPad**, and double-click on **ThinkPad Configuration**. The following window appears:

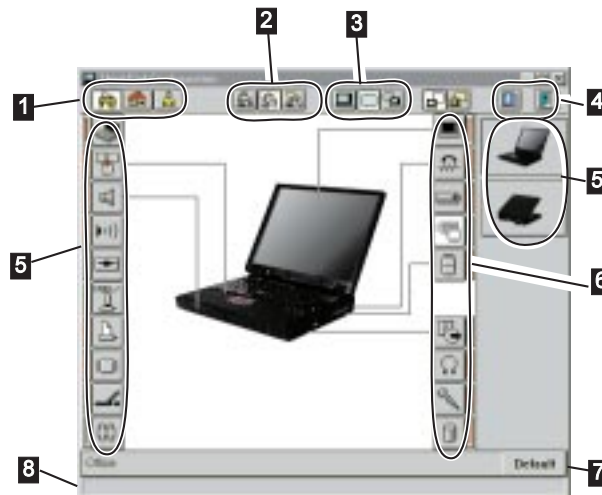

- 1 The **One-Touch Setup** buttons
Click on one of these buttons to set the system configuration.
- 2 The **Power Mode** buttons
Click on one of these buttons to set the power mode to high performance mode, automatic mode, or customized mode.

- 3 The **Display Device** buttons
Click on one of these buttons to set the display output type to the LCD, external display, or to both. When making a presentation, you can click on the presentation button to disable any system timers, such as the LCD turn-off timer or the power-save mode timers.
- 4 Click on the left button for **Help**. Click on the right button to save the changes made and to **Exit** the ThinkPad Configuration window.
- 5 The **View Angle** buttons
Click on the front view or rear view buttons to display the hardware feature locations.
- 6 The **Device** buttons
Click on the button of your choice from the window; then set the options for that device from the window that appears.

When the device is enabled, the red indicator next to the button is lit. Otherwise, it stays off.
- 7 The **Default** button
Click on this button to set the default values for each option and to cancel the changes you just made.
- 8 The **Status** bar
The device name and its status appears in the status bar when you place the cursor on a device button.

Only the top portion of the window is displayed when you click on the triangular minimize button in the top-right corner.

ThinkPad Configuration for DOS

You can use the ThinkPad Configuration program from the DOS prompt. To start the program, do the following:

- 1 Click on **Start** and the **DOS Prompt** icon. The DOS prompt screen appears.
- 2 Type `PS2 ?` at the `c:\ThinkPad>` prompt. The "ThinkPad Configuration" online help screen appears:

```
C:\>PS2 ?
```

```
(C) Copyright IBM Corp. 1993,1995. All rights reserved.
  US Government Users Restricted Rights - Use, duplication
  or disclosure restricted by GSA ADP Schedule Contract
  with IBM Corp.
```

```
Command Syntax: PS2 [Parameter1] [Parameter2] [Parameter3]
```

```
Following are available [Parameter1].
For the complete command syntax,
type 'PS2 ? [Parameter1]'.
```

```
1.Power Management related
```

```
  PMode,  SErIAL,  DDC,      CARd,
```

- 3** Select an item from the menu and follow the instructions on the screen to set the features.

You can also create a batch file like the one shown to match your operating environment. The following sample batch file sets a longer battery operating time.

```
@Echo Off
```

```
Rem SAMPLE:Set the parameters to provide maximum power utilization.
```

```
Rem =====
```



```

      PS2 PMode Custom DC           > Nul
      PS2 LCd 3                     > Nul
      PS2 DISK 3                    > Nul
      PS2 POver 5                   > Nul
      PS2 SPeed Fixed MIN           > Nul
      PS2 SStandby 3                > Nul
      PS2 IR OFF                    > Nul
      PS2 SErIAL OFF                > Nul
```

Switching Screens

To switch screens between the LCD and the external display or television, you should:

Start the ThinkPad Configuration program and click on either:

-  for the LCD screen.
-  for the external display or television screen. To switch to the television screen, your computer must have the optional DVD and Enhanced Video Adapter.

Or, use the **Fn+F7** keys.

Notes:

1. You cannot display a screen on television and on the external display screen at the same time.
2. You cannot display a screen on television and on the LCD screen at the same time.

Switching between the External Display and Television

If you are using the optional DVD and Enhanced Video Adapter, you can display the LCD output on an external display or television by doing the following:

- 1** Turn off the computer and attach an external display to the external-display port or a television cable to the video-out port at the rear of the computer.
- 2** Turn on the computer and start the ThinkPad Configuration program.
- 3** Click on the **Enhanced Video/MPEG** () button. The “Enhanced Video/MPEG” window appears.
- 4** If you want to use the television, select **Enable** for the **Video-out Port**; then go to the next step.

Note: Select **Enable** only when you have a television attached to your computer. Otherwise, the LCD screen turns

blank. If this happens, use the **Fn+F7** keys to restore the LCD output.

If you want to use the external display, select **Disable** for the **Video-out Port**; then go to step 6.

- 5** Select the appropriate television color standard: **NTSC** (default) or **PAL**.

For NTSC, you can select only the 640x480 screen resolution.

For PAL, you can select both the 640x480 and 800x600 resolutions.

- 6** Restart the computer to make the change effective.

Note: The LCD display always appears before the television display. If you selected the television, the display switches to the television after appearing momentarily on the LCD.

Using the TrackPoint

Your keyboard has a unique red button **1** called a *TrackPoint*, which functions like a mouse. Pushing this button in any direction moves the pointer in that direction on the screen. You can select an icon or a button by clicking on it, just as you would click on a mouse click button. You can use the TrackPoint together with the three click buttons **2**. The left and right click buttons function like the left and right click buttons on a mouse. The center click button enables the scroll and magnifying glass functions. Read the following section for details on these functions.

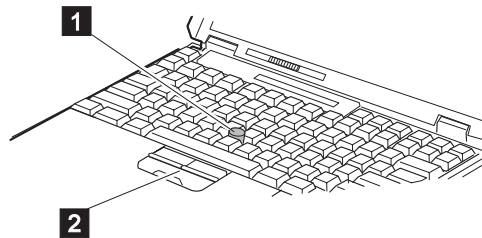

The function of the click buttons depends on the software you are using.

Operating the TrackPoint

- 1** Place your hands in the typing position and press gently on the stick with either index finger in the direction you want the cursor to move in.

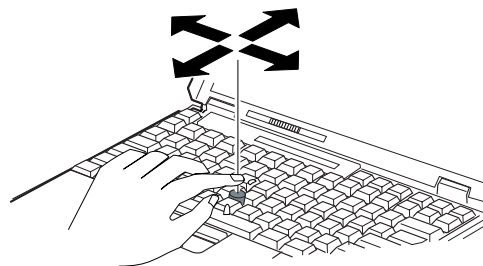

Pressing the stick away from you moves the cursor up the screen.

Pressing it toward you moves the cursor down the screen.

Pressing it sideways moves the cursor side to side.

- 2** Press the click buttons with either thumb to select and drag as required by your software, as with any other pointing device.

Notes:

1. Remember that the stick does not move, and your finger should not move on it.
2. The pointer may drift in some computer conditions. This is not a defect. Do not use the TrackPoint until the pointer stops moving.

Cleaning the Cap

The cap **1** on the end of the TrackPoint is removable. You can replace it with one of the spares shipped with your computer.

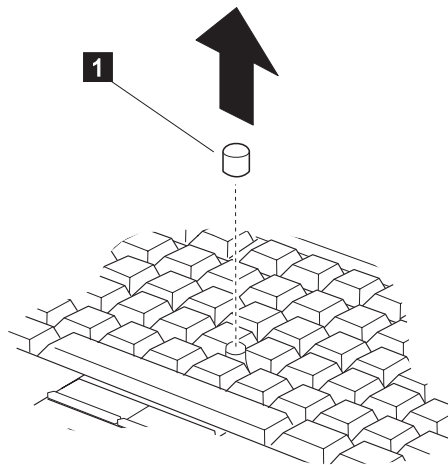

When the cap is worn out, replace it. You can remove the cap by pulling it off the TrackPoint stick.

Customizing the TrackPoint

To use the TrackPoint program, do the following:

- 1** Double-click on **My Computer**, **Control Panel**, and **TrackPoint**. The "TrackPoint Properties" window appears:



2 Select the features that you want to use.

The **Enable Press-to-Select** function

This function enables you to tap quickly on the TrackPoint to start programs, press buttons, use menus, and so on. You can always use the left click button and the right click button as mouse buttons.

The **Enable Dragging** function

This function enables you to drag and drop an object. Press down on the TrackPoint to grab the object. Then, drag the object by moving the TrackPoint. Drop the object by releasing the TrackPoint.

The **Enable Release-to-Select** function

This function enables you to click by simply lifting your finger quickly off the TrackPoint. **Release-to-Select** can also help you make a double-click. When you move the pointer onto an icon, and then lift your finger off the TrackPoint, one click is made (Release-to-Select). Then, when you press the TrackPoint again, the second click is made. The result is a double-click.

Press Means

Press-to-Select simulates only a single mouse button. Use this function to choose whether you want Press-to-Select to work like

a left click or a right click button. You can change the left click and right click button from the “Mouse Properties” window of the **Control Panel**.

If you set your **Button** configuration as right-handed, the right click displays a context menu and the left click works as a selector.

If you set the configuration as left-handed, the left click displays a context menu and the right click works as selector.

The **Click Pace** function adjusts how quickly you must press the TrackPoint for clicks and double-clicks. If you set the pace too slow, you might notice unintended clicks, a pointer delay, or a dragging delay. However, if you set the pace too quick, you might notice that it is hard to use Press-to-Select.

The **TrackPoint Sensitivity** function under the **Sensitivity** tab adjusts the force required for both cursor movement and Press-to-Select. Slide toward **Firm Touch** to increase the force needed to move the pointer, and to increase the force needed to activate Press-to-Select. Slide toward **Light Touch** to decrease the force needed to move the pointer, and to reduce the force needed to activate Press-to-Select.

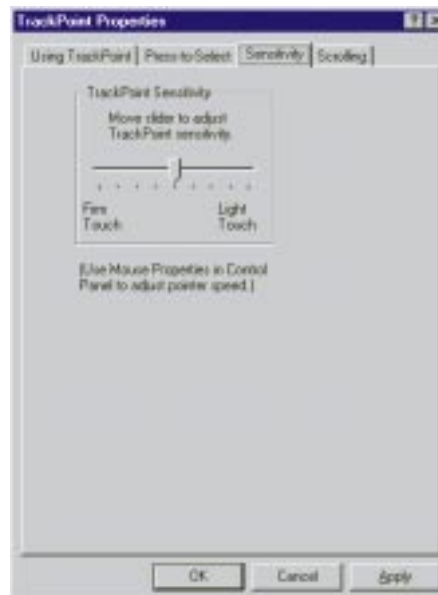

The **Choose Scrolling or Magnifying Glass Function** under the **Scrolling** tab enables you to do the following:

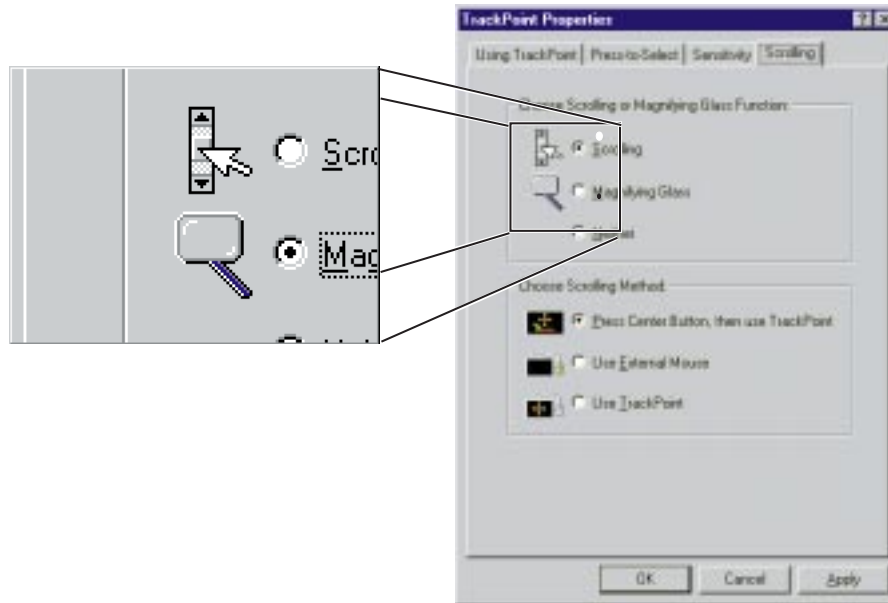

With the TrackPoint center button you can control the Scrolling or the Magnifying Glass feature.

The **Scrolling** function enables you to navigate easily through long documents or large spreadsheets with a press of a button. You never need to use a scroll bar again! To scroll, press the center button and then use the TrackPoint instead of the scroll bars in any program.

The **Magnifying Glass** enables you to enlarge a movable area of your display. You can click on objects “through” the Magnifying Glass. The right button changes the size of the Magnifying Glass, and the left mouse button changes its magnifying power. Move the magnified area the same way as you use the Scrolling function. By default, press the center button and then use the TrackPoint to move the magnified area.

Select the **Neither** button to disable the Scrolling and Magnifying Glass functions. The center button becomes mouse button 3.

Note: All Windows 95 and most Windows NT applications ignore mouse button **3**.

Choose Scrolling Method

Select which input device will be the scrolling device, that is, the device for Scrolling or Magnifying Glass control.

Press Center Button, then use TrackPoint

Holding down the center button on the keyboard allows the TrackPoint to control the Scrolling or Magnifying Glass. The TrackPoint operates normally (controls the mouse cursor) when the center button is not pressed.

Use External Mouse

This option sets an externally attached mouse to scroll (or move the Magnifying Glass) horizontally or vertically. Use the TrackPoint as a pointer.

Use TrackPoint

This option sets the TrackPoint to scroll horizontally or vertically. Use an externally attached mouse as a pointer. This setting is recommended if you have a mouse attached.

Note: You can still use the TrackPoint to control the mouse pointer by pressing the center button.

Using the ThinkPad Online Book

To see the online book, do the following:

Double-click on **My Computer**, **Control Panel**, and on **ThinkPad 770 User's Guide**. The online book appears.

Go to the respective section and make a printout if necessary. The online book covers the topics in more detail.

Using the Security Features

This section describes how to use the following security features:

- Passwords
- Personalization features

Using Passwords

The password setting feature prevents your computer from being used by others. You can set the following passwords on your computer:

The **Power-on password** protects your computer from being used by unauthorized persons.

The **Hard Disk password** protects the data on your primary hard disk from being accessed by unauthorized persons. You can also set a password for your secondary hard disk.

The **Supervisor password** protects the system information stored in Easy-Setup and also makes your computer tamper-resistant.

Setting a Password

A password protects your computer from being used by unauthorized persons. Once you set a password, a prompt appears on the screen each time you turn on the computer. You must enter your password at the prompt. You will not be able to use the computer unless you type the correct password.

To set a password, do the following:

- 1** Start Easy-Setup (refer to "Using Easy-Setup" on page 2-54).
- 2** Click on **Password** in the "Easy-Setup" menu. The first "Password" submenu appears:

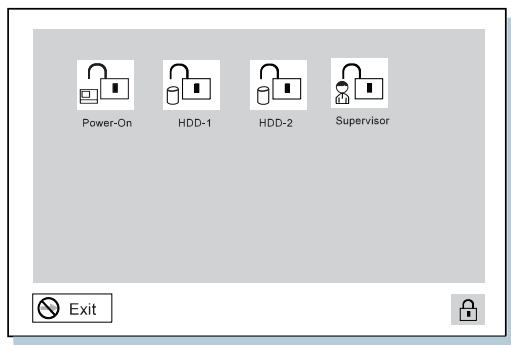

Selecting this icon displays a submenu for setting the **power-on** password.



Selecting this icon displays a submenu for setting the **hard disk** password.



Selecting this icon displays a submenu for setting the **supervisor** password.

Note: An unlocked keylock icon indicates a password that is not yet set.

- 3** Click on the type of password you want to set: **Power-On**, **Hard Disk**, or **Supervisor**. The next “Password” submenu appears.

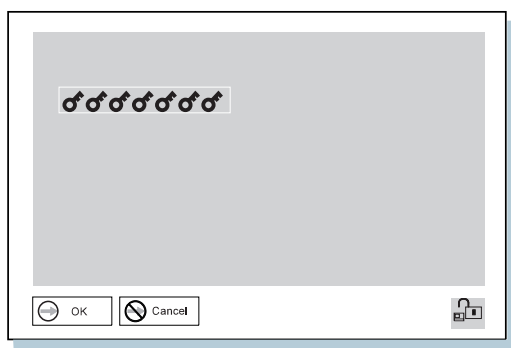

- 4** Type an appropriate password.
You can type a maximum of 7 random characters using a combination of letters (A to Z) and numbers (0 to 9).

Uppercase and lowercase letters (for example, *A* and *a*) are treated as the same characters.

If you type a wrong character, use the **Backspace** key to erase it and then type the correct one.

5 Press **Enter**. The “Password Confirmation” submenu appears:

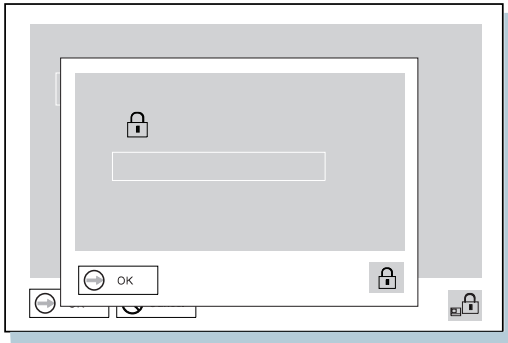

6 Type your password again to verify it; then press **Enter** again.

Note: The following submenu appears if you are setting the hard disk or the supervisor password, reminding you to write down the password on piece of paper and to keep it in a safe place.

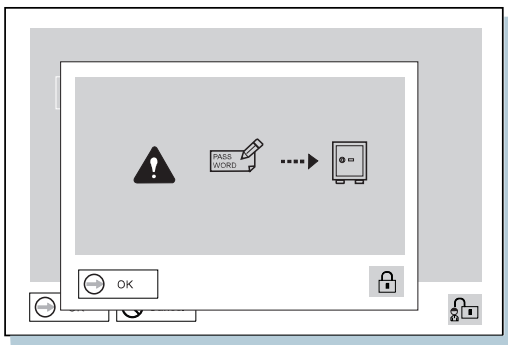

Your password is set.

Don't Forget Your HDD and Supervisor Password

If you forget your hard disk or supervisor password, there is **no way to reset your password or recover data from the hard disk**. You will have to take your computer to an IBM authorized reseller or an IBM marketing representative to have the hard disk or the system board replaced. Proof of purchase is required, and an additional charge might be required for the service.

Changing or Removing a Password Using Easy-Setup

This security feature prevents someone from removing a password and using your computer. To remove a password, do the following:

- 1 Start Easy-Setup (refer to “Using Easy-Setup” on page 2-54). The password prompt appears (only when the supervisor password is set):

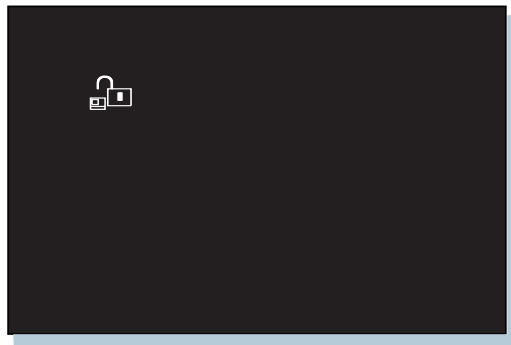

- 2 Enter the supervisor password. The “Easy-Setup” menu appears.
- 3 Select **Password** on the menu. The “Password” submenu appears.
- 4 Select the password that you want to change or remove.
 - Power-On
 - Hard Disk
 - Supervisor

A submenu appears.

To change a password, go to the next step.

To remove a password, go to step 8 on page 2-21.

- 5** Enter the password you wish to change and press the **Spacebar**. A submenu appears:

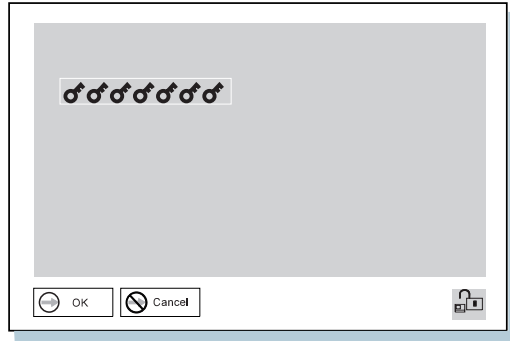

- 6** Type the new password. Press **Spacebar**. A submenu appears:

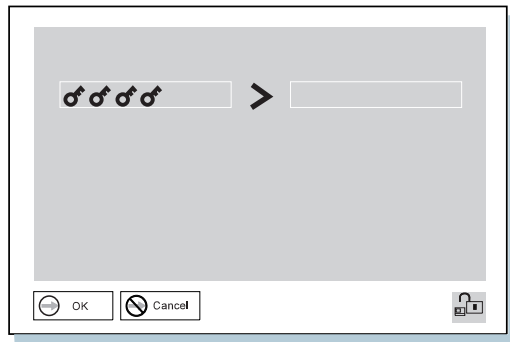

- 7** Type the new password again; then press **Enter**. The "Password" submenu appears and the password is changed. Go to step 11 on page 2-22.

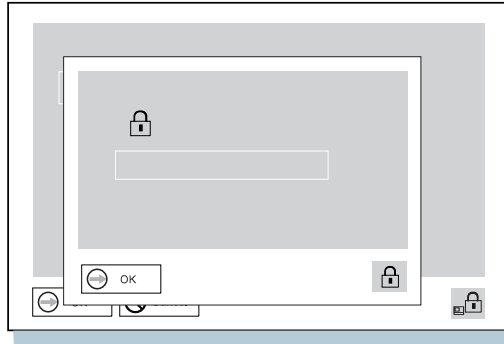

8 Enter the password you wish to remove and press the **Spacebar**. A submenu appears:

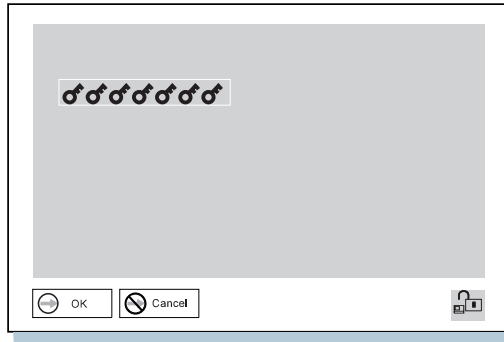

9 Press **Enter**. A submenu appears.

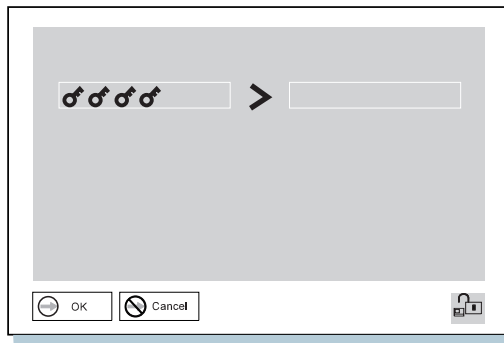

10 Press **Enter** again. The “Password” submenu appears and the password is removed.

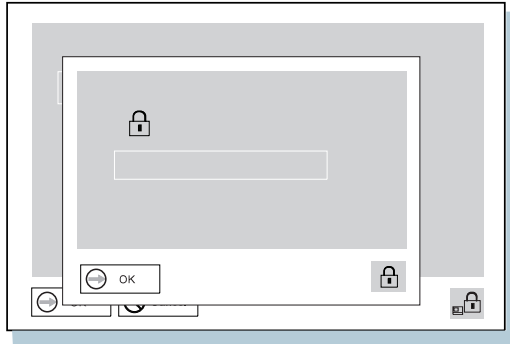

11 Click on **Exit**.

12 Select **Restart**. Your computer restarts.

Entering a Password

Once you set a password, a password prompt appears at the top left corner of the screen. This prompt appears each time you turn on your computer or when your computer returns from suspend mode to normal operation.

However, a password prompt is not displayed if the computer returns to normal operation by a preset timer or an incoming call on the modem, in which case you will have to display it by pressing a key or moving the pointing device.

To enter a password, do the following:

- 1** Type your password. The symbol appears each time you press a key. Don't hold down a key too long since the same character will be entered continuously.
- 2** Press the **Enter** key.

An **OK** appears if you enter the correct password, and an **X** appears if you enter the wrong password. If you fail to enter the correct password in three tries, you must turn off the computer, wait 5 seconds, and then turn it on again and retry.

Using the Supervisor Password on Several Hard Disk Drives

If you are using several hard disk drives, you must set a supervisor password for each of these drives. The same password that you set for the supervisor password is set as the hard disk password. You can use the same supervisor password that you set on the main hard disk drive for the secondary hard disk drive in the UltraBay II. To set a supervisor password for the hard disk drive in the docking station, you must move the hard disk drive to the UltraBay II, set a password there, and then reinstall the drive in the docking station.

Setting the Supervisor Password on Several Hard Disk Drives

- 1** If you haven't set a supervisor password, set it now. Refer to "Setting a Password" on page 2-16. When you set the supervisor password, your computer automatically sets the same password for the hard disk drive.
- 2** Remove the device from the UltraBay II and install a secondary hard disk drive.
- 3** Turn on the computer. A 158 error appears.
- 4** Press **Enter**. The power-on password prompt appears.
- 5** Type your supervisor password. The supervisor password is set for the secondary hard disk drive and your operating system starts.

If the error code 158 appears again, go to "Error Codes or Screen Messages" on page 4-5.
- 6** Turn off the computer. Repeat steps 2 through 6 to set the supervisor password for the other hard disk drives that you may be using in the future.

Changing or Removing the Supervisor Password on Several Hard Disk Drives

- 1** If you haven't changed or removed the supervisor password on your computer, do it now. Refer to "Changing or Removing a Password Using Easy-Setup" on page 2-19.

2 Remove the device from the UltraBay II and install the hard disk drive with the old supervisor password.

3 Turn on the computer. The hard disk password prompt appears.

4 Do one of the following:

If you changed the supervisor password in step 1, change the old password on the hard disk drive to the new supervisor password by doing the following:

- a) Typing your *old* password and pressing the **Spacebar**.
- b) Typing your *new* password and pressing the **Spacebar**.
- c) Typing your *new* password again.

If you removed the supervisor password in step 1, type the old supervisor password; then press the **Spacebar**.

5 Press **Enter**.

6 Turn off the computer.

To change or remove the supervisor password for each hard disk drive, repeat steps 2 through 6.

Using the Personalization Editor

When you use the Personalization Editor, you can display such personal information as your name and address on the screen each time you power on your computer. To display this information, the power-on password must already have been set. This feature helps you to identify your computer when identical computers are being used in your location, or to deter theft.

To register your name, address, and company on the Personalization Editor, do the following:

1 Click on **Start**, select **Programs** and **ThinkPad**, and click on **Personalization Editor**. The following window appears:

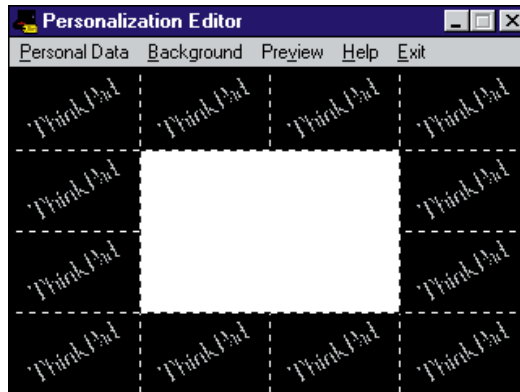

- 2** Click on **Personal Data** and type in the necessary information into the boxes.

Name:	Gordon Harper
Company:	DazzleTech, Inc.
Address:	831 S. Silver St. Yaho Falls, WA 98531
Phone:	206-744-3251
Message:	Please return this computer to the above address. Thank you.
	<input type="checkbox"/> Black background

Click on **Help** for more information.

The information that you typed in will be displayed the next time you power on.

Saving Battery Power

Your battery pack should be useful for approximately 3 years. The number of years or charge-discharge cycles may vary depending on how wisely you use your computer. This section describes the following:

- How to use the power management modes.
- How to use other battery saving methods.
- How to check your battery status.

Using the Power Management Modes

You can use your computer under battery power for a considerable length of time by using the following power management modes:

Standby Mode

Your computer enters this mode by default when there is inactivity on your computer for a set duration of time. You can also enter this mode by pressing the **Fn+F3** keys.

To return to normal operation, press any key or move the TrackPoint.

Suspend Mode

In this mode, your computer stops all tasks and stores all data in memory. You can enter suspend mode by:

- Pressing the **Fn+F4** keys
- Closing the cover
- Selecting the **Suspend** button () in the Fuel program

You cannot enter suspend mode or resume normal operation when the right bay eject lever is open.

Hibernation Mode

In this mode, your computer stops all tasks and stores all data in the hard disk; then it powers off. You should set your computer to this mode when you want to maintain the present operating condition until the next day, for instance. **RediSafe** is another hibernation mode option.

You can set hibernation mode by doing any of the following:

- Pressing the **Fn+F12** keys.
- Selecting the **Hibernation** button () in the Fuel program.

Notes:

1. You cannot enter hibernation mode or resume normal operation when the right bay eject lever is open.
2. You cannot enter hibernation mode when you are using the communication network.
3. Hibernation mode might be terminated if you connect your computer to a docking station or if you use a particular PC Card.

The following figure shows the relationship between the different power management modes and battery power consumption:

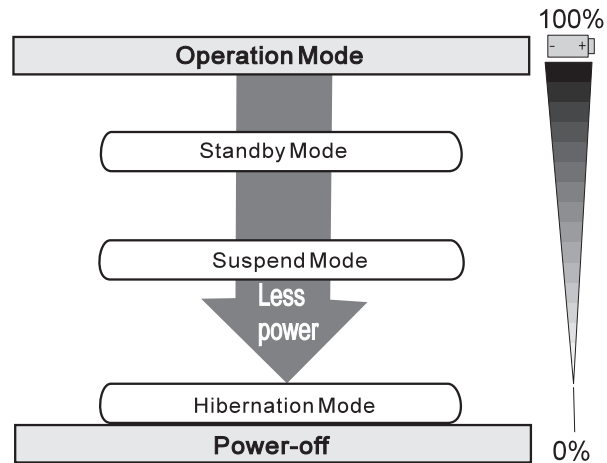

Setting the Suspend Timer



To set the suspend timer, do the following:

For Windows 95

- 1** Start the ThinkPad Configuration program (refer to “ThinkPad Configuration Program for Windows 95” on page 2-3).

- 2** Click on the **Power Management** () button. The “Power Properties” window appears.
- 3** Select the **Power Mode** tab. The “Power Mode” window appears.
- 4** Select **Customize**. The bottom gray portion is displayed in black, and you can specify the timeout value in minutes in the **Suspend Timer** box.
- 5** Click on **OK**.

For Windows NT

- 1** Start the ThinkPad Configuration program (refer to “ThinkPad Configuration Program for Windows NT” on page 2-4).
- 2** Click on the **Power Management** () button. Three buttons appear on the right.
- 3** Click on the **Power Mode Settings** () button. The “Power Mode Settings” window appears.
- 4** Specify the timeout value in minutes in the **Suspend Timer** box.
- 5** Click on **OK**.

Enabling Hibernation Mode



To enable hibernation mode, do the following:

For Windows 95

- 1** Start the ThinkPad Configuration program (refer to “ThinkPad Configuration Program for Windows 95” on page 2-3).
- 2** Click on the **Power Management** () button. The “Power Properties” window appears.
- 3** Select the **Hibernation** tab. The “Hibernation” subwindow appears.

- 4** Click on **Enable Hibernation**. (If you already created a hibernation file, this button appears in gray and you cannot click on it.) The “Enable Hibernation” subwindow appears.
- 5** Click on **Create Now**.
- 6** Click on **OK**.

For Windows NT

- 1** Start the ThinkPad Configuration program (refer to “ThinkPad Configuration Program for Windows NT” on page 2-4).
- 2** Click on the **Power Management** () button.
- 3** Click on the **Suspend/Resume Options** () button. The “Suspend/Resume Options” window appears.
- 4** Add a check mark () on the option you want to set.
- 5** Click on **OK**.







For Windows NT Users

You cannot create a hibernation file in a Windows NT system that uses the NTFS format system, the Windows NT default format. If you want to use hibernation mode, you should reinstall Windows NT with a FAT format system.

The following chart shows how to switch between the different power management modes.

Checking the Battery Status

You can check the status of your battery by looking at the battery status indicator.

Battery Status Indicator	Remaining Power (Percentage)	Status and Action
	100%	Full battery power remains.
	Less than 75%	Sufficient battery power remains.
	Less than 50%	Sufficient battery power remains.
	Less than 25%	Not much battery power remains.
	0%	No battery power is available for operation.
 (Blinking)	You have only 10 minutes left for battery operation.	<p>The battery pack is almost discharged and is about to enter a low-battery condition. Do either of the following immediately:</p> <ul style="list-style-type: none"> Change to ac power operation by connecting the AC Adapter to your computer and to a power outlet. Replace the battery pack with a fully charged one. <p>If corrective action is not taken within 30 seconds, the computer enters suspend mode.</p>
	—	The battery pack is being charged (appears only when the AC Adapter is connected). The battery pack cannot be charged if the battery overheats. Charging is resumed when its temperature decreases.

Battery Status Indicator	Remaining Power (Percentage)	Status and Action
	—	The battery pack is being discharged or is being used.
Off	—	The battery pack is not installed. The computer is turned off.

Attention

Do not leave the computer in the blinking state for a long time. If you leave it in this state, data in the memory will be lost.

Notes:



1. If you had set the alarm with the ThinkPad Configuration program, you will hear three beeps the moment this indicator starts blinking.
2. If this indicator starts blinking, the indicated percentage may not be accurate. You need to repeat discharging and charging of the battery pack at least three times.

Using the Fuel Program

The Fuel program enables you to do the following:

- Enable suspend mode
- Enable hibernation mode

This program also displays the following status:

- The battery charge status
- The remaining battery power percentage and duration of remaining power
- The current power mode
- Operation mode
 - Battery-powered operation mode ()
 - AC-powered operation mode ()

To start the Fuel program click on **Start**, select **Programs** and **ThinkPad**, and click on **Fuel**. The following window appears:

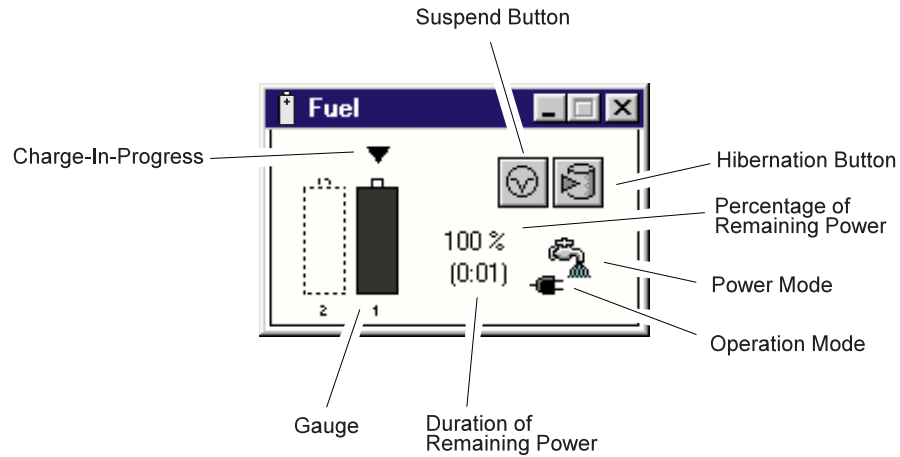

If you want to erase this window from the desktop, press the **Fn+F2** key combination. It reappears the next time you press this key combination.

If you want to see Help, click on the **Fuel** button  at the upper left of the window.

Changing the Battery Status Indication

When you want to change the indication from percent (77%) to hours and minutes (2:50) or vice versa, do the following:

- 1 Click on the upper left corner of the "Fuel" window and select **Option...** from the pull-down window.

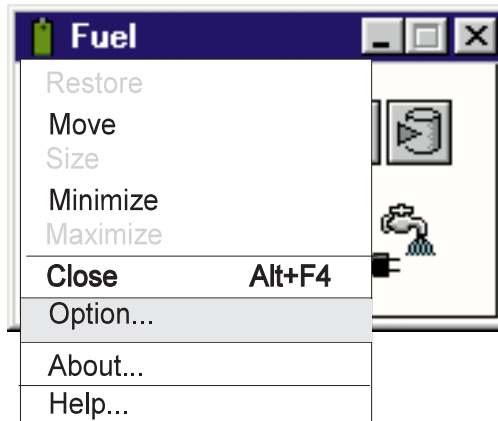

- 2 Click on your choice; then click on **OK**.

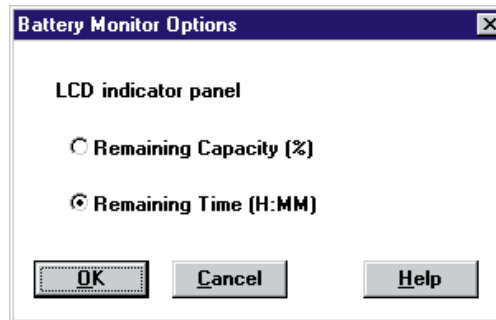

Using the Audio Features

Your computer is equipped with the following:

A 1/2-inch (3.5-mm) diameter external stereo line-in or monaural microphone/line-in jack.

A 1/2-inch (3.5-mm) diameter stereo headphone or an external-powered speaker jack.

A MIDI/joystick port on the port replicator. To use a MIDI device, you should first connect your computer to a port replicator; then connect an external MIDI device to the port replicator. After docking your computer in the port replicator, you should enable this port using the ThinkPad Configuration program.

Your computer also has an audio chip that enables you to enjoy the various multimedia audio features. This audio chip provides the following features:

Recording and playing back of PCM and WAV files in 8-bit or 16-bit format.

Sampling of various rates from 8 KHz to 44 KHz for the WAV file.

Playing back of MIDI files through an FM synthesizer.

Recording from various sound sources, such as an integrated microphone, an external microphone, or an audio device attached to a line-in jack or an integrated CD-ROM drive.

DOS game compatibility. You should select Sound Blaster Pro** for the audio adapter in the sound setup of the game.

The 3D Sound Retrieval System (SRS) function compensates for the flat, two dimensional sound image limitations by reestablishing the necessary information that allows the human ear to hear in three dimensions.

Models equipped with the internal modem use the Advanced Communication Adapter, which enables you to use the digital signal processor (DSP) WaveTable MidiSynth function.

Using the 3D Sound Retrieval System (SRS) Function

To use the SRS function, do the following:

- 1 Double-click on the small speaker icon () at the bottom right of the Windows desktop.

or

Click on the **Start** button, and then select **Programs**, **Accessories**, **Multimedia**, and **Volume Control**. The “Master Out” window appears:

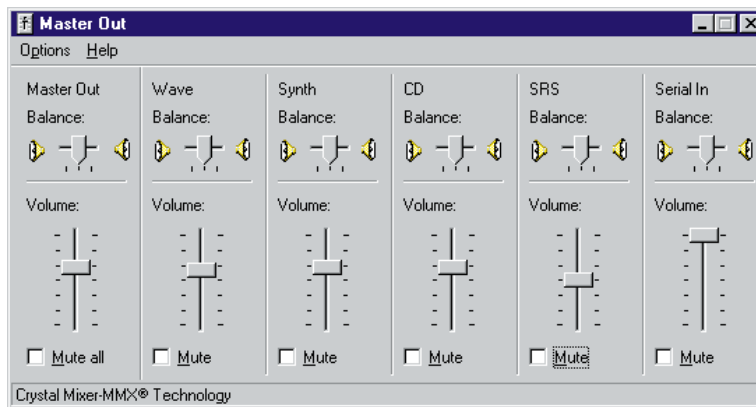

- 2 Make sure that the **SRS Balance** column is displayed and the **Mute** checkbox is unchecked.
- 3 If the column is displayed and the checkbox is not checked, exit the window. You can use the SRS function; skip the remaining steps.

If the column is not displayed, select **Options** on the upper left corner of the window and select **Properties**. The “Properties” window appears:

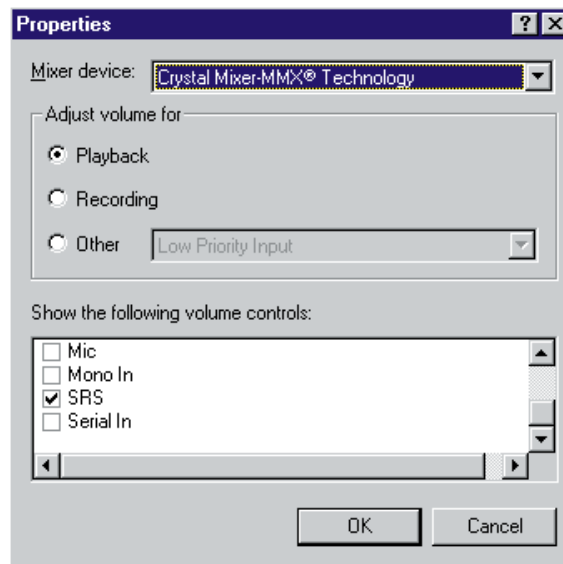

4 Put a check mark on **SRS** and press **OK**. You return to the “Master Out” window.

5 Make sure that the **Mute** checkbox is unchecked.

6 Exit the “Master Out” window.

Now you can use the SRS function.

Using the MIDI Features

To use the MIDI features, do the following:

1 Click on the **Start** button, and select **Settings, Control Panel,** and **Multimedia**. The “Multimedia Properties” window appears:

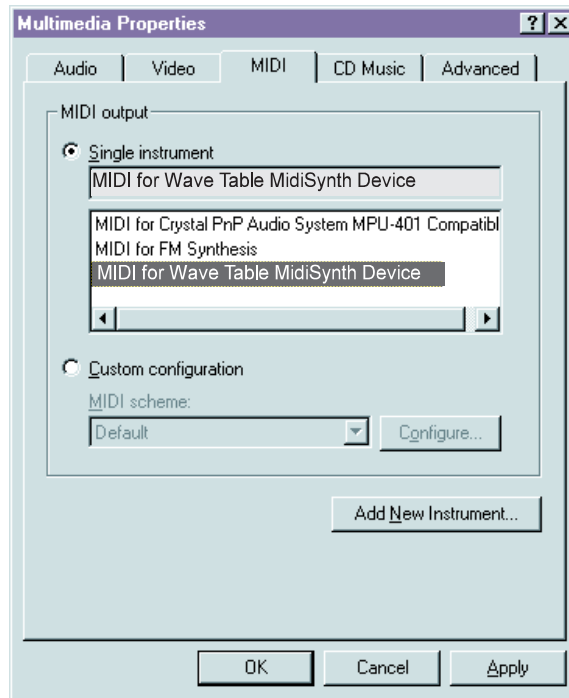

2 Select the **MIDI** tab.

3 Select the **MIDI for Wave Table MidiSynth Device** when you want better quality sound. You can then use the Wave Table MIDI sound.

or

Select **MIDI for FM Synthesis** when you want to use FM MIDI sound. This is the default setting.

or

Select **MIDI for Crystal** PnP Audio System MPU-401 Compatible** when you want to use the external MIDI device attached to the port replicator.

4 Click on **OK** to exit the window.

Now you can use the MIDI function.

Using the ThinkPad Modem

The ThinkPad modem, available on some models, enables you to send or receive data, faxes, and voice over the telephone line. This modem uses a digital signal processor (DSP) and its software can be upgraded, allowing great flexibility. It enables you to enhance the modem capability to 56 Kbps.

Data modem functions

- Asynchronous communications port interface (NS16550A UART compatible) operation
- ITU-T V.34 up to 33.6 Kbps data modem
- ITU-T V.32bis protocols with data rates of 4800, 7200, 9600, 12000, and 14000 bps
- ITU-T V.32 protocols with data rates of 4800, 9600 uncoded, and 9600 bps Trellis coded
- ITU-T V.21/V.22, V.22bis protocols with data rates from 300 bps to 2400 bps
- Hayes** AT command set compatibility
- Asynchronous error recovery protocol
- Microcom Network Protocol (MNP**) protocols
 - Error correction via MNP classes 1–4
 - Data compression via MNP class 5 and V.42bis
 - MNP class 5 for up to 2x data compression
- VoiceView (Windows 95 only)

Facsimile (fax) modem functions

- Class 1 fax modem
- Class 2 fax modem
- G3 transfers
- ITU-T T.4 & T.30 operations
- ITU-T V.27ter-2400/4800 bps send/receive
- ITU-T V.29-7200/9600 bps send/receive
- ITU-T V.17-14400 bps send/receive

You can use this ThinkPad modem only on a public-switched telephone network (PSTN). You cannot use a private branch exchange (PBX) or some other type of digital telephone extension line. If you connect the modem to a line other than PSTN, an error message appears, preventing you from using the line. If you are not sure which kind of phone line you are using, contact your telephone company.

Attention for Use Overseas

In many countries, you cannot use the ThinkPad modem function before obtaining approval from the proper authorities.

Your ThinkPad modem is a worldwide modem and can be used in any country where Postal Telegraph and Telephone (PTT) type approval has been obtained. If the country you want is not on the **Country Selection** listing, see <http://www.us.pc.ibm.com/thinkpad/thinkpad.html> on the Internet, and download the newest Country Selection list.

If you are a non-U.S. user, run the Country Selection program in the **ThinkPad Modem** folder after you complete the ThinkPad Modem installation. The "Country Selection" window enables you to change the country name to the country in which you are actually going to use the ThinkPad Modem telephony function in. Click on **ThinkPad Modem** in your operating system; then click on **Country Selection**. Confirm whether the selection matches the country name in the **Dialing Properties** listing (for Windows 95).

For more information on the use of the internal modem in a specific country, contact the IBM customer support center in that country. You can look up the phone number by referring to the international service information booklet that came with your computer.

DANGER



To avoid shock hazard, do not connect the cable to or disconnect the cable from the telephone outlet on the wall during electrical storms.

To use the ThinkPad modem, connect one end 1 of the telephone cable to the telephone jack; then connect the other end 2 to the telephone outlet on the wall.

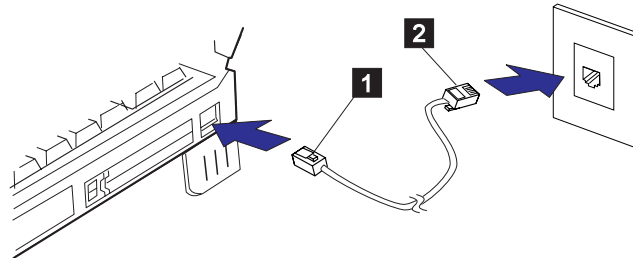

Using the ThinkPad Modem in Windows 95 and Windows NT

When you start Windows, the ThinkPad Modem automatically starts and will be ready for use.

Using the ThinkPad Modem in OS/2

To start the ThinkPad modem from OS/2, do the following:

- 1 Open the **Communications for OS/2** folder.
- 2 Double-click on the **Modem** icon.
- 3 Start your communication program.

Using the 56 Kbps Modem

Your modem can be upgraded to enable communication speeds of up to 56 Kbps (receive only). For upgrade information refer to:

<http://www.us.pc.ibm.com/thinkpad/thinkpad.html>

To take advantage of your modem's 56 Kbps x2** technology, you must first make sure that your internet service provider (ISP) supports a 56 Kbps modem protocol.

- 1 Contact your ISP and determine which 56 Kbps modem protocol they use.

2 Determine which 56 Kbps modem protocol your modem supports. To view your modem's supported protocol, do the following:

- a) Click on the **Start** button, and select **Programs** and **Modem** (or **Modem & Audio**).
- b) Click on **Modem**.
- c) Choose **Options** from the "Modem Status" window; then choose **Settings**.

The available transfer speeds are displayed. The 56 Kbps protocol your modem supports is listed in parentheses following the 56 Kbps transfer setting.

If no 56 Kbps transfer setting is listed, your modem's 56 Kbps technology is not currently enabled. Refer to the user's guide supplement for details.

Your modem and your ISP must support the same 56 Kbps protocol, or your maximum connection speed will be limited to V.34 technology.

Significantly higher Internet modem connection speeds up to 56 Kbps require all-digital transmission connections from your ISP to the line card in the central office to which your phone line is connected. The actual rate of reception is limited by the quality of your telephone line, which may vary from location to location.

In the U.S., current FCC regulations limit the maximum speed for downstream communication to 53 Kbps. Even though your modem contains 56 Kbps technology, connect rate in the receive direction might be significantly less than 56 Kbps.

Currently, 56 Kbps capability is in the receive direction only (from the ISP to your local modem). The transmit or send direction (from your local modem to the ISP) uses V.34 technology.

Note: 56 Kbps transfer rates are not available in all locations or countries. You must check with your ISP to determine if your area is capable of 56 Kbps transfer rates.

Telephony Features

The ThinkPad modem, with the associated software, provides the following telephony features:

Industry standard modem support up to 33.6 Kbps

Industry standard fax support up to 14.4 Kbps

Computer telephony function support

- DTMF and pulse dialing
- Detecting DTMF digits received from the phone line
- Call progress monitoring
- Auto-dialing feature
- Telephony API (TAPI) support through Windows 95 Unimodem V (Windows 95 only)
- Microsoft MS Phone support
- VoiceView support for the SystemSoft Talkshop application and Windows 95 File Transfer (Windows 95 only)
- IBM Digital Simultaneous Voice over Data (DSVD) support at 33.6 Kbps

Telephone answering machine support (Windows 95 only)

- Recording and playback of messages and greetings
- Answering device with caller ID
- Modem class 8 AT commands for TAPI calls

Full-duplex speaker phone support (Windows 95 only)

- Acoustic echo cancelation

Other

- DOS box operation for 33.6 Kbps data and 14.4 Kbps fax
- System level and device level power management

Using the DVD and Enhanced Video Adapter

The DVD and Enhanced Video Adapter, available as standard on some models and as an option on others, enables you to view DVD discs with video contents, such as business presentations and DVD movies. It also enables you to use the video overlay and capture functions as well as the MPEG function when you connect a television or a home video equipment to the video-in/out ports. The MPEG function enables you to view MPEG-1 and MPEG-2 videos.

The DVD and Enhanced Video Adapter allows you to take advantage of the following:

DVD and MPEG playback: With the MPEG playback feature, you can play many available video CD, CD-i movies, and DVD titles. No DOS/CD-i game titles are currently supported.

Video-in:

- You can capture still images or motion video from such video equipment as a video cassette recorder (VCR).
- You can overlay motion video from video equipment.

Video-out: Refer to “Attaching a Television to Your Computer” on page 3-22 on how to use the video-out port.

You will need to install the optional DVD drive to play DVD titles.

Note: You should remember the following points when using the DVD and Enhanced Video Adapter:

You cannot enable or disable this feature while the playback or capture window is open. Close the playback or the capture window before you make any changes.

The MPEG playback and the video-in (video capture) functions use the same hardware resources. Only one of the two functions can be used at a time. Likewise, no two MPEG functions can be used at the same time.

Instructions for using the DVD and Enhanced Video Adapter depends on your operating system:

For Windows 95, go to “Using the DVD Enhanced Video Adapter with Windows 95” on page 2-45.

For OS/2, go to “Using the Enhanced Video Features in OS/2” on page 2-51.

Using the DVD Enhanced Video Adapter with Windows 95

This section describes how to use the DVD and Enhanced Video Adapter in Windows 95:

“Using the Capture Function”

“Using the Overlay Function” on page 2-47

“Using the MPEG Playback” on page 2-49

“Using the DVD Player” on page 2-50

Using the Capture Function

On your computer, you can use the capture applications supported by Video for Windows. You can also overlay motion video from the video-in port by using applications supported by the MCI (Media Control Interface) overlay.

Notes:

1. Only one capture window can be open at a time.
2. When you use video capture with the overlay screen on, the captured screen might be distorted. However, the data is correctly captured.

To capture motion video, do the following:

- 1** Turn off the computer.

- 2** Connect the video in-out cable 1 to the video-in port (Ⓜ) 2 of the computer; then connect your video equipment.

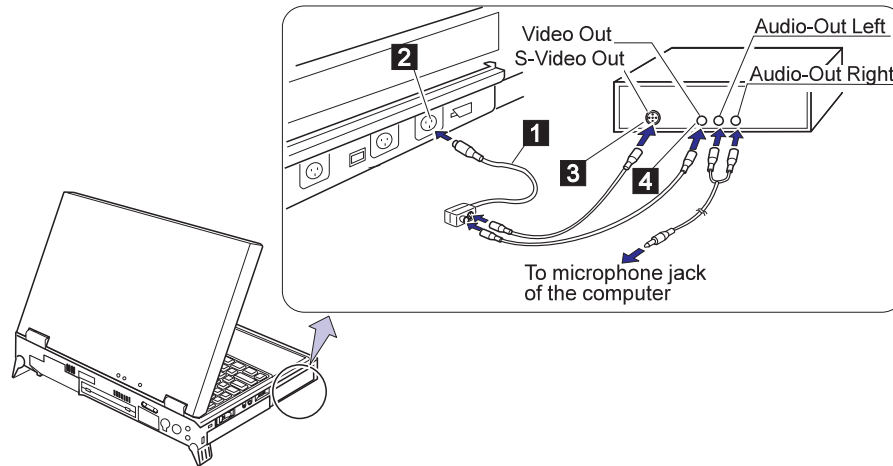

Only the video in-out cable 1 is supplied with your computer. The other cables are not supplied; you must purchase them.

If you are using video equipment with an S-video output, connect the S-video port of the video in-out cable to the S-video-out port 3 of your video equipment for better picture quality.

If you are **not** using video equipment with an S-video output, connect the video in-out cable to the video-out port 4 of your video equipment.

If your video equipment has only one audio-output port, use the left-audio connector of the audio cable.

- 3** Check the Enhanced Video status.

- a) Open the ThinkPad Configuration program.
- b) Select the **Enhanced Video/MPEG** button (Ⓜ).
- c) If **Video capture/MPEG status** is enabled, go to step 5.
If not, continue to the next step.
- d) Click on **Advanced**.

e) Click on the **1st IRQ** list box and assign an IRQ for the device. (The default IRQ is 11.)

4 Restart the computer to make the IRQ setting effective.

5 Start the video capture application program.

If you are going to use the Digital Video Producer (DVP) program, see the online help included in the application.

If you are going to use the Media Player, go to "Using the Overlay Function."

Using the Overlay Function

You can use the video overlay function using the Media Player for Windows 95. To view a video using the overlay function, do the following:

1 Open **Media Player** in Windows.

2 Click on **Device**.

3 Select **MCI OVERLAY Driver**.

Operational Restrictions

The following shows restrictions when using the Enhanced Video functions in Windows 95:

You cannot change the video resolution when you are capturing, overlaying, or playing back an MPEG file.

You can use only one video application at a time—for example, you cannot capture video while playing back an MPEG file.

Video overlay, capture, and MPEG playback functions do not work under the following video modes:

- 800x600 resolution and 16M colors
- 1600x1200 resolution and 256 colors
- All 16 color modes

Do not select virtual screen in the ThinkPad Configuration program.

Video overlay, capture, and MPEG playback functions are not supported in virtual screen mode, such as the 1280x1024 resolution on an LCD.

For better motion video quality of MPEG-2 and DVD movie playback, you should select 1024x768 resolution 256 color.

Audio streams are decoded in software. MPEG/DVD playback performance is contingent upon the speed and power of the system. Audio subsystem needs to be fully functional.

MPEG playback and Video overlay/capture requires Microsoft DirectX 2** support.

DVD titles cannot be played by Media Player. You must use a DVD player application.

Using the MPEG Playback

The MPEG feature enables hardware to decode MPEG playback files under playback application programs.

To use MPEG playback in Windows 95, do the following:

- 1** Open **Media Player**.
- 2** Click on **Device**.
- 3** Do one of the following:
 - When you want to play MPEG files, select **IBM MPEG-2**.
 - When you want to play a movie or CD, select **CD-i/VideoCD**.
- 4** When you want to play a video CD or a CD-i movie from the CD-ROM drive of your computer, click on the **Play** (▶) icon. Otherwise, select the MPEG file you want to play; then click on the **Play** (▶) icon.

Changing the Drive Letter

You must change the drive letter when you use the MPEG playback function. To change the drive letter for CD-i/VideoCD, do the following:

- 1** Select **Control Panel** from the **My Computer** folder.
- 2** Click on the **Multimedia** icon.
- 3** Select **Advanced**.
- 4** Click on **Media control device**.
- 5** Click on **IBM MPEG CD-i/VideoCD[mci]**.
- 6** Confirm that **Use this Media Control device** is selected; then select **Settings**.
- 7** Change the drive letter.

Using the DVD Player

When you install the optional DVD drive and the player application shipped with the option, you can view various DVD titles. You can view DVD movies on your computer screen or on your TV.

When you attach your computer to the television, you can view a DVD movie on your TV screen either as an MPEG full-screen or as a computer-overlay screen. You can switch between these two modes by using the **Fn+F7** keys. To enable this screen switching function, you should select **Enable** for the **Video out port (TV out)** on the “Enhanced Video/MPEG” window of the ThinkPad Configuration program. In summary, you can view a DVD movie on the following:

LCD Screen	External Display	TV Screen
MPEG on Graphics	Not applicable	MPEG full screen (when you play MPEG)
No image	Not applicable	Computer overlay screen (no image if the movie is copy-protected)

You cannot use this screen switching function if you selected **Disable** for the **Video out port (TV out)** on the “Enhanced Video/MPEG” window of the ThinkPad Configuration program. Then you can see a DVD movie only as an MPEG full-screen image on your TV. In summary, you can see as follows:

LCD Screen	External Display	TV Screen
MPEG on Graphics	Same as LCD screen	MPEG full screen (when you play MPEG)

Warning

Copyright-protected DVD movies can be viewed only as a full-screen image on the TV, not as a computer-overlay screen image. If you are viewing this type of movie in full TV screen mode and you try to switch to the computer-overlay screen mode using the **Fn+F7** keys, your screen will turn black. Press these keys again to return to the full TV screen mode.

Copyright-protected DVD movies contain copy-protect signals that prevent them from being copied. These images, played back on the VCR, are distorted.

To attach your computer to the television, refer to “Attaching a Television to Your Computer” on page 3-22.

Using the Enhanced Video Features in OS/2

You can capture still images and motion video using the video capture application Video IN supported by MMPM/2, and the video-in port of your computer.

Notes:

1. You need at least 12 MB of memory to capture video from the video-in port using Video IN.
2. When installing the Enhanced Video device driver, install Video IN from the BonusPak, prior to the device drivers.
3. The DVD/MPEG feature is not supported in OS/2.

To capture a motion video, do the following:

- 1** Turn off the computer and connect the video in-out cable **1** to the video-in port (⏏) **2** of the computer; then connect your video equipment.

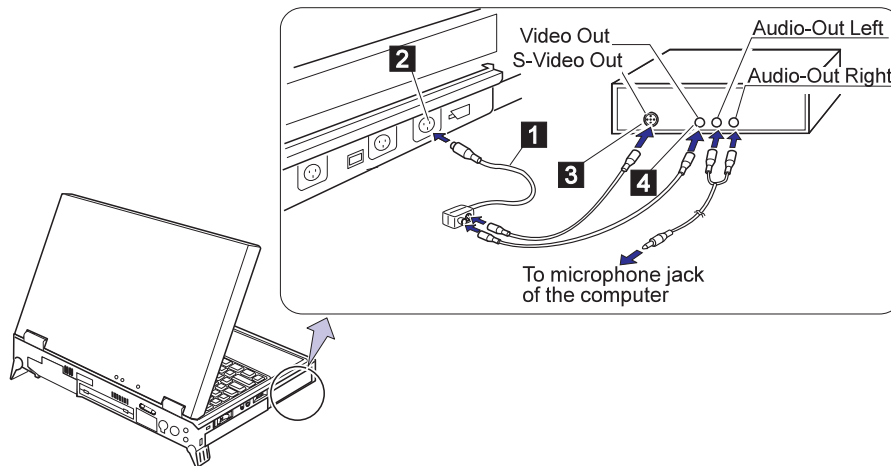

Cables other than the video in-out cable **1** are not supplied with the computer.

If you are using video equipment with S-video output, connect the S-video port of the video in-out cable to the S-video-out port of your video equipment **3** for better picture quality.

If you are **not** using video equipment with S-video output, connect the composite video port of the video in-out cable to the video-out port of your video equipment **4**.

If your video equipment has only one audio-output port, use the left-audio connector of the audio cable.

- 2** Check the Enhanced Video status.
 - a) Open the ThinkPad Configuration program and select the **Enhanced Video/MPEG** button (⏏).
 - b) If **Video capture/MPEG status** is enabled, go to step 4. If not, continue to the next step.

- c) Click on **Advanced**; then click on the **1st IRQ** list box and assign an IRQ for the device. (The default IRQ is 11.)

Operational Restrictions

You must be aware on the following points when using the Enhanced Video feature:

Do not use the Enhanced Video feature (capturing or overlaying video images using the Video-IN Recorder) in the following display modes:

- 800x600 resolution and 16M colors,
- 1600x1200 resolution and 256 colors

If you use the Enhanced Video feature in these display modes, the image may be corrupted.

Do not select virtual screen in the ThinkPad Configuration program.

The video overlay and the capture functions are not supported in virtual screen mode, such as the 1280x1024 resolution on an LCD.

Using Easy-Setup

Your computer provides a user-friendly program called “Easy-Setup” that allows you to select various setup parameters. You should perform this program before you start using your computer. Do the following steps to start the program:

- 1** Turn off the computer, and remove any diskette from the diskette drive.
- 2** Press and hold **F1**; then turn on the computer. Hold **F1** until the “Easy-Setup” menu appears:

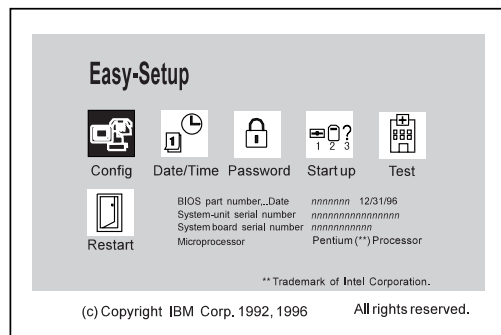

- 3** Move to an icon you want to change, using the arrow keys or the TrackPoint, and click on the icon. A submenu is displayed.
- 4** Change the items you wish to change.
- 5** Click on **Exit** to exit to the “Easy-Setup” menu.

Changing the Screen Color

You can change the color of the “Easy-Setup” menu by pressing the **Ctrl+PgUp** keys or by pressing the **Ctrl+PgDn** keys.

To return to the original color, press the **Ctrl+Home** keys.



Pressing the **Config** button displays the “Config” submenu. It shows information about the installed memory and system board. You can also use the Multiple Display function, and enable or disable the Wake-On-LAN and Flash-Over-LAN functions. Go to “Knowing Your Configuration” on page 2-56.



Pressing the **Date/Time** button displays the “Date and Time” submenu. It is used to set the current date and time. Go to “Setting the Date and Time” on page 2-57.



Pressing the **Password** button displays the “Password” submenu. It is used to set the power-on password, hard disk password, and the supervisor password. Go to “Using Passwords” on page 2-16.

Notes:

1. An icon for **HDD-2** is displayed in solid black if an optional secondary hard disk exists in the UltraBay II. It will be displayed in a lighter shade if this option is not installed.
2. An unlocked lock icon shows a password not yet set.



Pressing the **Start up** button displays the “Start up” submenu. It is used to change the startup sequence of your computer. Go to “Changing the Drive Startup Sequence” on page 2-57.



Pressing the **Test** button displays the “Test” submenu. It is used to run diagnostic tests on your computer to check for hardware errors. Go to “Testing Your Computer” on page 4-32.



Pressing the **Restart** button ends the Easy-Setup program and restarts the computer.

Knowing Your Configuration

To find out which devices are installed on your computer, do the following:

- 1** Start Easy-Setup (refer to “Using Easy-Setup” on page 2-54).
- 2** Click on **Config** in the “Easy-Setup” menu. The “Configuration” submenu appears:

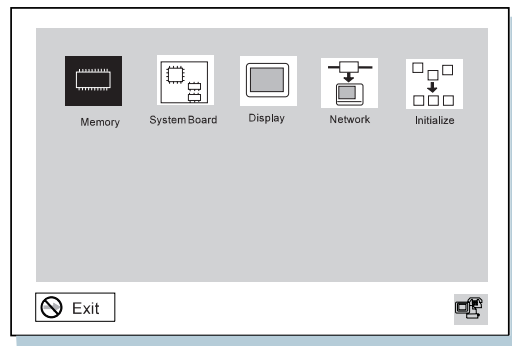

- 3** Move the cursor to any device icon whose information you want and click on it. Detailed information on that device is displayed.



The **Memory** button shows the amount of memory installed and available.



The **System Board** button provides information on the installed system board.



The **Display** button sets the screen output to be displayed on either a **Single** screen or on **Multiple** screens.



The **Network** button sets the **Wake** on LAN, the startup sequence, and the **Flash** update features. For further information, refer to the chapter on “Total Cost of Ownership” in the online book.



Initialize sets all device settings to the default values.

- 4 Click on **Exit** to exit from the submenus, or press **Esc** to cancel the selection.

Setting the Date and Time

To change the date and time, do the following:

- 1 Start Easy-Setup (refer to “Using Easy-Setup” on page 2-54).
- 2 Click on **Date/Time** on the “Easy-Setup” menu. The “Date/Time” submenu appears:

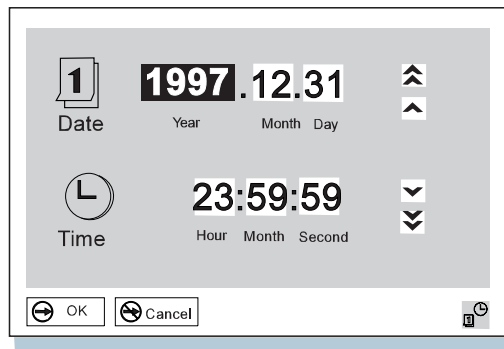

- 3 Move the cursor to any field (year, month, date, hour, minute, or second) and place the pointer on any of the arrow icons (▲, ▼, or ↕) to adjust the date and time. Clicking on the double-arrow icon scrolls the numbers faster.
- 4 Click on **OK** to save the changes or on **Cancel** to cancel it.

Changing the Drive Startup Sequence

This feature enables you to change the startup sequence of the drives in your computer. It is useful when you have different operating systems on different replaceable hard disk drives or in PC cards. You can have the system boot up from these devices.

Attention

You must be extremely careful not to specify a wrong device during a copy, save, or a format operation after you change your startup sequence. If you do, your data and programs will be erased or overwritten.

To change the startup sequence, do the following:

- 1** Start Easy-Setup (refer to “Using Easy-Setup” on page 2-54).
- 2** Click on **Start up** in the “Easy-Setup” menu. The “Startup” submenu appears:

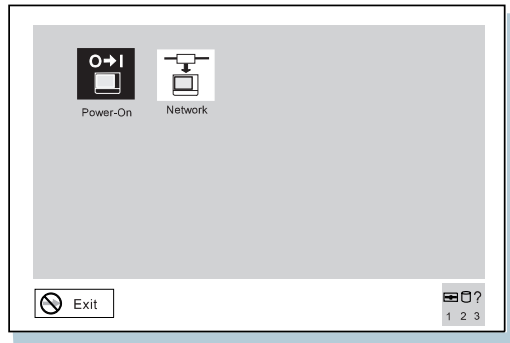

The **Power-On** button sets the startup sequence of your computer.



The **Network** button sets the network functions of your computer.

For more information on this function, refer to the chapter on “System Management” in the online book.

- 3** Click on **Power-On** in the submenu. The “Power-On” submenu appears:

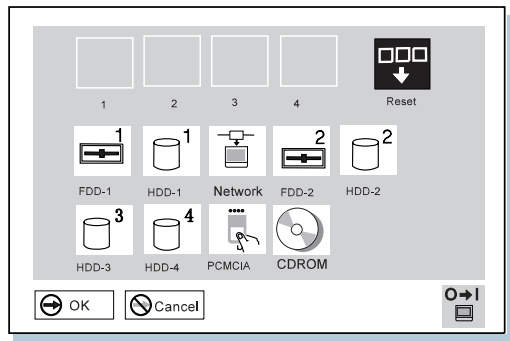

The **FDD-1** icon is the diskette drive in the UltraBay II, if you have one. If you don't have one but you have a diskette drive

in the docking station, that diskette drive becomes **FDD-1**. If you have an additional diskette drive, that drive becomes **FDD-2**.

The hard disk drive in your computer is **HDD-1**. If you have a hard disk drive in the UltraBay II, that drive becomes **HDD-2**. The **HDD-3** and **HDD-4** are the external hard disk drives on the docking station.

- 4** Move the cursor to the **Reset** icon; and click on it.
- 5** Select the first device you want for the startup sequence; then click on it.

The device moves up to box **1**. You cannot set a hard disk drive before a PCMCIA** card.
- 6** If you are using a remote program loading (RPL) system through a token-ring card or some other network card, do the following:
 - a** Select **Network** and click on it. The "Speed" menu appears.
 - b** If you are using a token-ring card, select the speed you want (**4** or **16**), and click on it; then press **Enter**.

If you are using a network card other than a token-ring card, such as an Ethernet card, you need not specify the RPL speed. Press **Esc** and exit this menu.
- 7** Repeat these steps for the other devices. You can set up to four devices.
- 8** Click on **OK** or press **Enter** to save the changes.



Chapter 3. Installing Options

This chapter describes how to install (and remove) the following options:

Installing IBM Options	3-2
Installing a Memory Option	3-2
Replacing the Hard Disk Drive in the HDD Bay	3-5
Installing the Battery Pack	3-6
Removing and Installing a Device in UltraBay II	3-7
Installing the Secondary Hard Disk Drive	3-9
Installing the Secondary Battery Pack	3-10
Installing the DVD and Enhanced Video Adapter	3-10
Replacing the Backup Battery	3-11
Attaching a Mouse, a Numeric Keypad, or an External Keyboard	3-13
Inserting or Removing a PC Card	3-15
Installing Other Devices	3-17
Using a Docking Station	3-17
Docking with Your Computer Powered Off	3-18
Undocking with Your Computer Powered On or While in Suspend Mode	3-19
Presetting a Device to Avoid a Resource Conflict	3-20
Using the Security System Lock	3-21
Attaching a Television to Your Computer	3-22

Installing IBM Options

This section describes how to install (and remove) IBM options.

Installing a Memory Option

You can increase the amount of memory in your computer by installing a *dual inline memory module (DIMM)*.

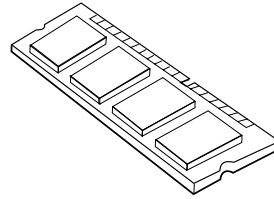

Attention

To avoid damaging the DIMM memory board electrically, do not touch the connector edge directly with your hands.

- 1** Turn off your computer; then disconnect the AC Adapter and all cables from the computer.
- 2** Discharge any static electricity that may be in your body by touching a metal object with your hands.
- 3** Turn the computer upside down.
- 4** Open the bottom compartment with a screwdriver **1** and remove the bottom cover **2**.

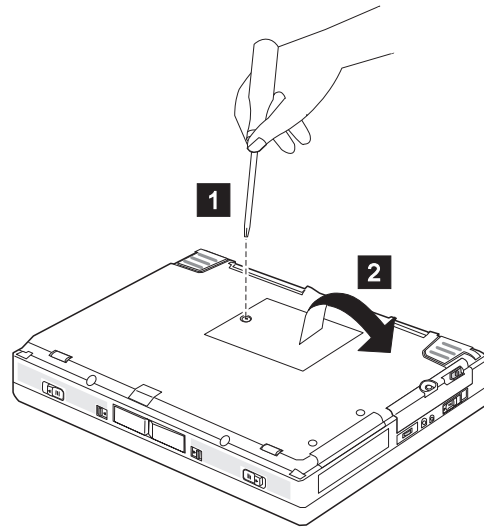

5 Locate the DIMM socket and insert the DIMM **3** so that its notch aligns with the tab on the socket; then pivot the DIMM **4** .

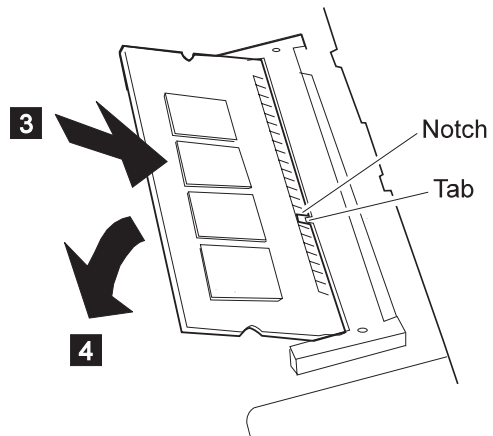

The DIMM should be inserted into either socket at an angle of approximately 20°.

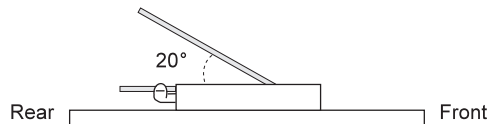

- 6** If you have another DIMM, install it into the vacant socket.

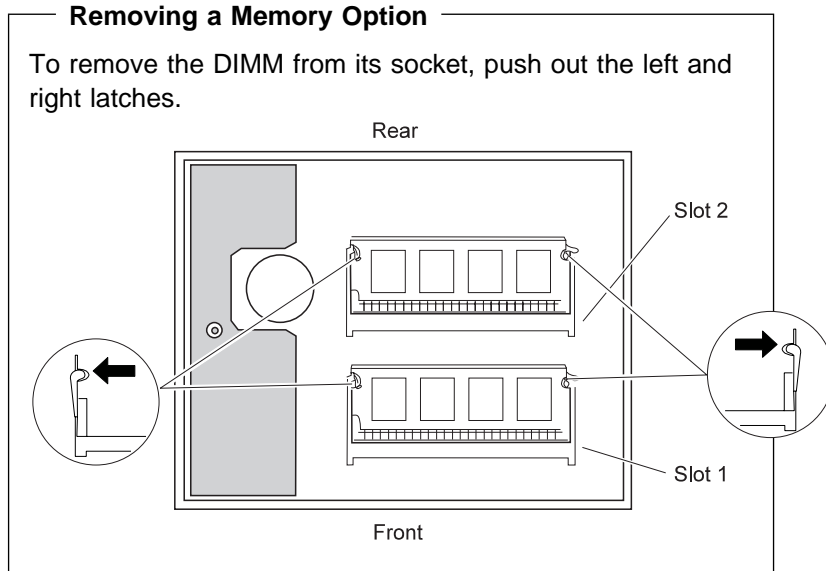

- 7** Replace the bottom cover and the screw, and turn the computer rightside up.
- 8** Connect the AC Adapter to the computer.
- 9** Power on the computer and confirm the new memory size. For example, information such as the following appears:

```
32384 KB OK
```

- 10** Is the new memory size what you expected?
- Yes** You have installed the DIMM successfully. Go to the next step.
- No** Go to "Testing Your Computer" on page 4-32.
- 11** Turn off the computer and reconnect all cables.

Replacing the Hard Disk Drive in the HDD Bay

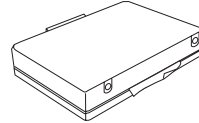

Attention

The hard disk is a delicate device; therefore, handle it carefully. You can damage this device if you drop it on a hard surface.

- 1** Turn off the computer; then disconnect the AC Adapter and all cables from the computer.
- 2** Turn the computer upside down, unscrew the HDD bay cover screw **1** using a coin, slide the latch to the rear **2**, and remove the bay cover **3**.

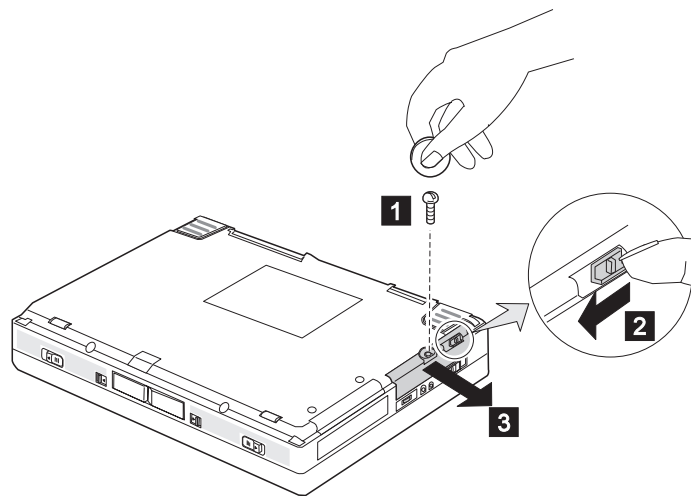

Note: To prevent others from gaining access to the hard disk drive, you can change the coin screw at the rear with a normal screw shipped with your computer.

- 3 Pull out the hard disk drive from the bay.

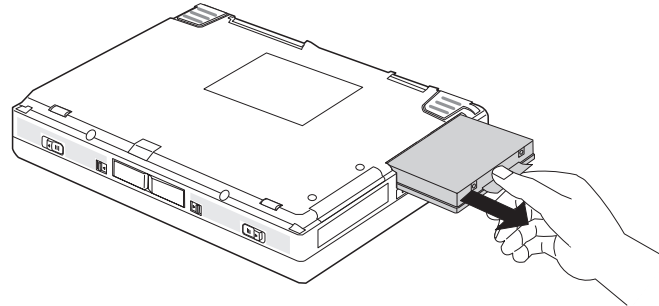

- 4 Insert the new hard disk drive into the bay and screw on the HDD bay cover.

Make sure you insert the hard disk drive with the **label facing down**.

- 5 Turn the computer rightside up, connect the AC Adapter to the computer, and turn on the computer.

Installing the Battery Pack

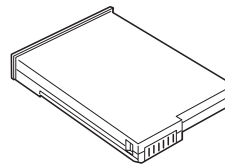

If you are going to use ac power without the battery pack, or if you want to replace the battery pack, do the following:

Slide the left release latch to the left **1** and gently lift up the bay eject lever **2** and pull out the battery pack **3**.

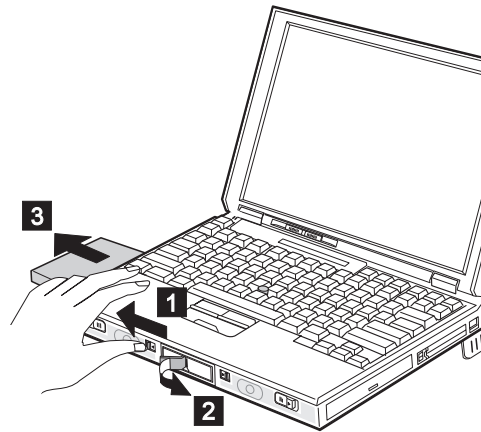

Insert the new battery pack until it snaps into place; then push in the bay eject lever to the level position.

Make sure you **align the slanted edge** of the battery pack with the slant on the battery bay.

Removing and Installing a Device in UltraBay II

You can install one of the following devices in UltraBay II:

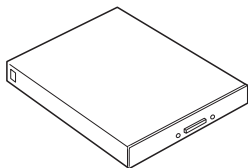

CD-ROM Drive

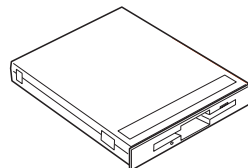

Diskette Drive

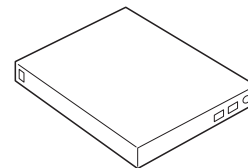

DVD Drive

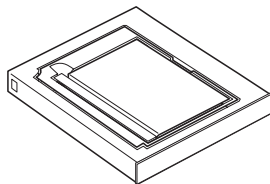

Secondary Hard Disk Drive
(requires a secondary HDD adapter)

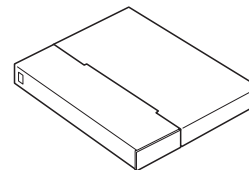

Secondary Battery Pack
(requires a battery adapter)

Before you remove a CD-ROM device or a diskette drive from the UltraBay II, make sure there are no CD-ROMs or diskettes inserted in the drive.

To remove a device from the UltraBay II, do the following:

- 1** *(Cold unplugging only.)* Power off the computer, disconnect the AC Adapter, and disconnect all cables from the computer.
- 2** Slide the right release latch to the right 1 .

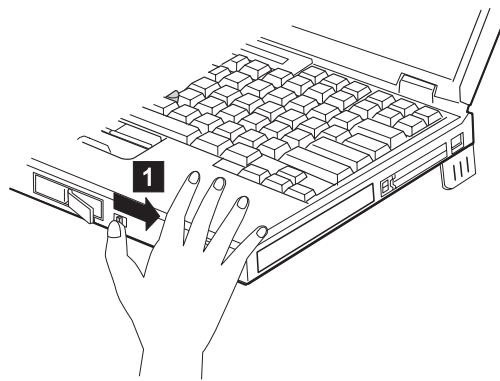

- 3** Gently lift up the bay eject lever 2 and remove the device from the bay 3 .

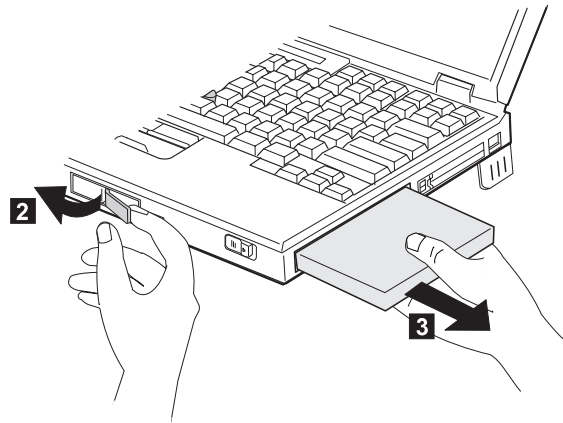

- 4** Install another device into the UltraBay II by referring to the manuals shipped with the option.

Make sure you **align the slanted edge** of the device with the slant on the UltraBay II.

- 5** You can install the screws shipped with your computer to prevent others from gaining access to the device (see page 1-6).

Installing the Secondary Hard Disk Drive

Before you install the secondary hard disk drive into the UltraBay II, do the following:

- 1** Attach the ThinkPad 770 Second Hard Disk Drive Adapter option 770 adapter component 1 .
- 2** Open the disk stopper 2 , install the hard disk drive into the adapter 3 .

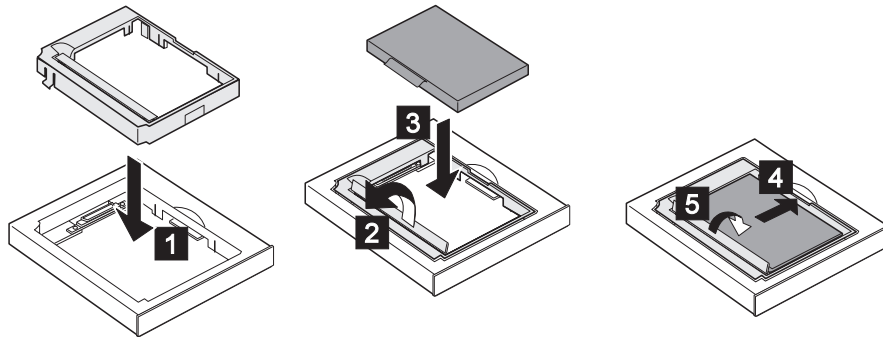

- 3** Slide the hard disk drive to the right 4 and close the stopper 5 .

Note: The ThinkPad 770 Second Hard Disk Drive Adapter option includes a 760 and a 765 adapter component for installing the ThinkPad Model 760 and 765 hard disks.

- 4** Install the secondary hard disk drive adapter option into the UltraBay II.

Installing the Secondary Battery Pack

Before installing a secondary battery pack into the battery bay, attach the battery pack to the adapter case; then insert it into the bay.

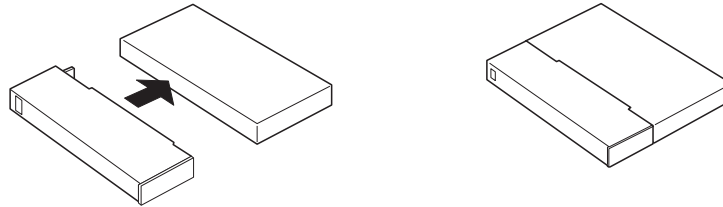

Installing the DVD and Enhanced Video Adapter

To install the adapter, do the following:

- 1** Turn the computer upside down.
- 2** Remove the battery pack.
- 3** Remove the screws on the adapter slot **1** and remove the cover **2**.

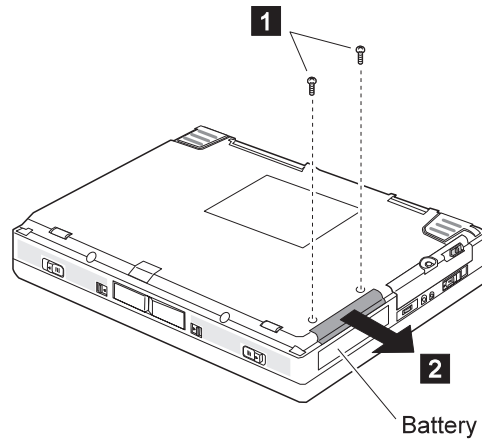

- 4 Insert the adapter into the slot 3 and replace the screws 4 and the battery pack.

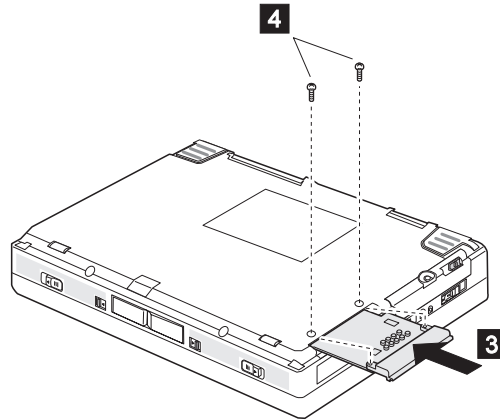

- 5 Turn the computer rightside up.

Refer to “Using the DVD and Enhanced Video Adapter” on page 2-44 for details on the usage.

Replacing the Backup Battery

This section explains how to replace the backup (lithium-ion) battery in the bottom compartment.

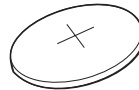

- 1 Turn off the computer; then disconnect the AC Adapter and all cables from the computer.
- 2 Turn the computer upside down.

- 3 Open the bottom compartment with a screwdriver 1 and remove the bottom cover 2 .

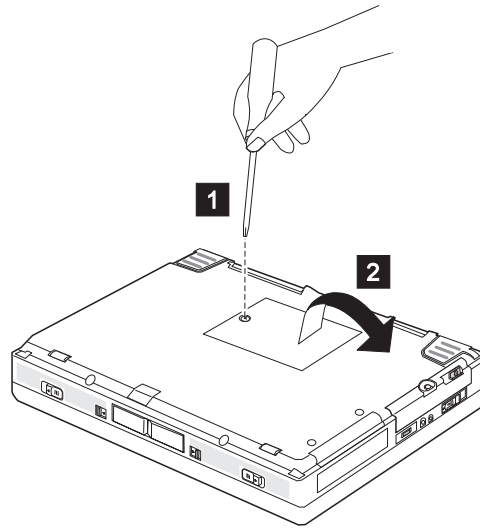

- 4 Find the old backup battery in the bottom compartment and remove it from the battery holder by pushing it in 3 ; then lifting it up 4 .

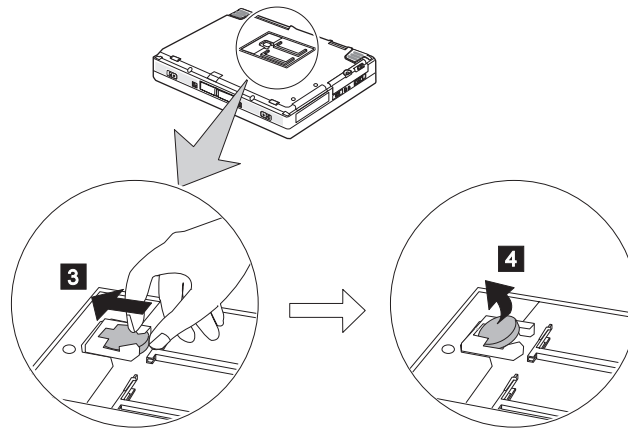

- 5 Install a new backup battery.
- 6 Replace the bottom cover.
- 7 Connect the AC Adapter to the computer.

Attaching a Mouse, a Numeric Keypad, or an External Keyboard

You can attach a mouse, a numeric keypad, or an external keyboard to the external-input-device port.

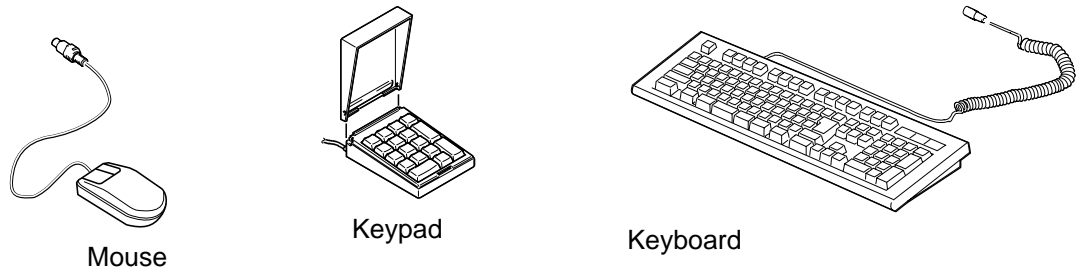

You must turn off your computer before connecting the mouse.

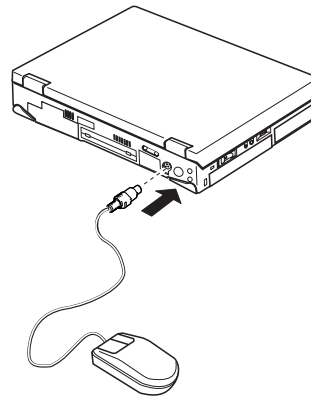

If you want to use the external numeric keypad and the mouse at the same time, first connect the keypad cable to the computer **1** ; then connect the mouse cable **2** to the connector on the keypad.

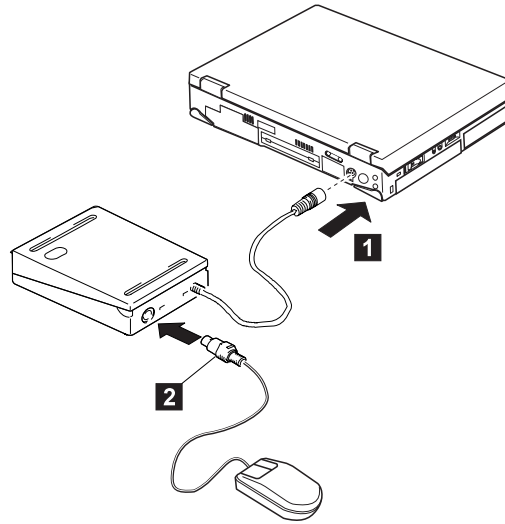

If you want to use an external keyboard and a mouse at the same time, you must use the optional keyboard/mouse connector cable and do the following:

- 1** Turn off the computer.
- 2** Connect the optional keyboard/mouse connector cable to the external-input-device port **1** on your computer.

- 3** Connect the external keyboard and mouse to the connectors **2** on the cable connector.

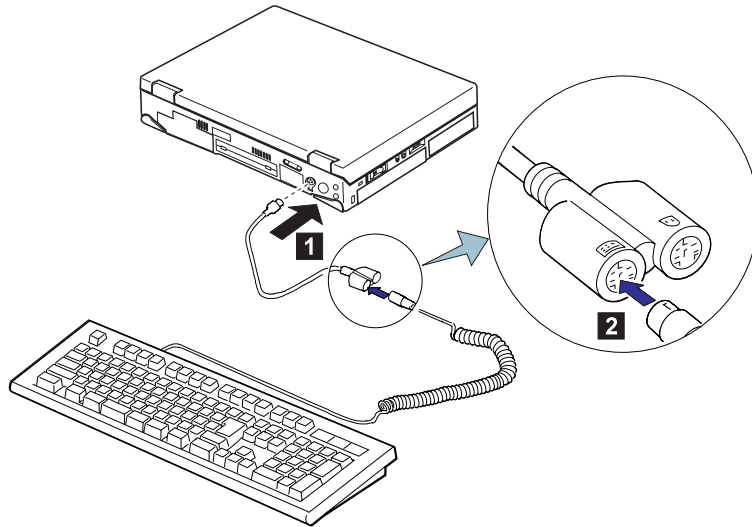

You cannot use the numeric keypad on your computer when you are using the external keyboard.

Inserting or Removing a PC Card

This section explains how to insert and remove a PC Card.

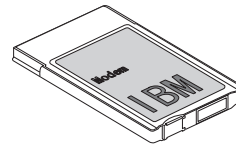

Your computer has an upper and a lower PC Card slot. This slot supports the following type of cards:

- PCMCIA (Type I, Type II, and Type III)
- CardBus
- Zoomed Video (ZV)

You can insert a Type I and a Type II card into the upper **1** and lower **2** slots and a Type III (double-height) card into the lower slot.

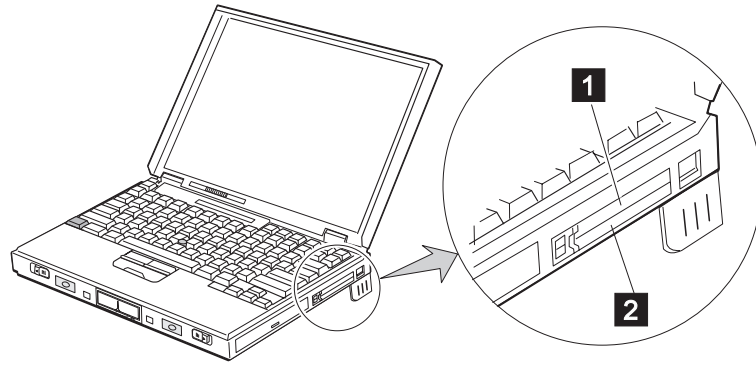

Refer to the chapter “Using PC Cards” in the online book for details on their usage.

1 Make sure that the notch **3** on the PC Card is on the left.

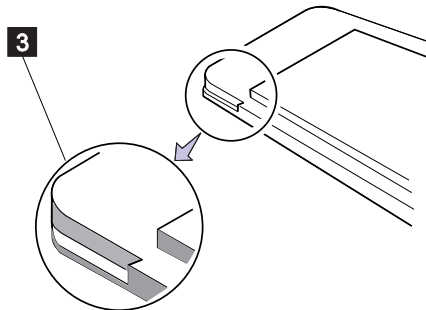

2 Insert the PC Card all the way into the slot.

To remove a card, push the button; the card will pop out.

Installing Other Devices

Using a Docking Station

You can extend the capabilities of your computer by docking it first to the SelectaBase 770 port replicator and then to a docking station:

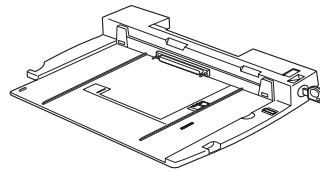

SelectaBase 770
(Port Replicator)

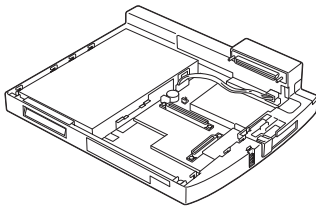

SelectaDock I
(ISA 1/PCI 1,
UltraBay 1)

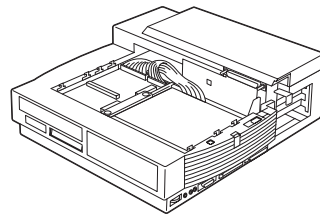

SelectaDock II
(ISA 2/PCI 3, UltraBay 2,
Half-height Bay 1)

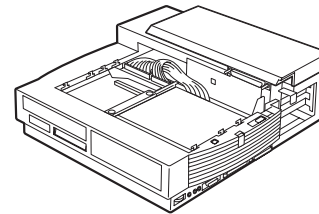

SelectaDock III
(ISA 2/PCI 3, UltraBay II 1,
Half-height Bay 1, USB 2)

You can dock your computer to a docking station under the following conditions:

- With your computer powered off (*cold docking*).
- With your computer operating (*hot docking*)
- With your computer in suspend mode (*warm docking*)

Notes:

1. Depending on the hardware configuration or the operating system, docking with your computer while powered on or in suspend mode might not be supported. Refer to the user's guide shipped with these options for instructions on how to dock your computer to a docking station.
2. You might not be able to read the indicator panel or access the

diskette drive easily on the SelectaDock I after you dock it with the SelectaBase 770 port replicator.

Docking with Your Computer Powered Off

You should dock with both your computer and your docking station powered off when:

It is the first time you dock your computer to the docking station.

You have changed the device configuration of your docking station, such as when you have installed or removed a device.

This resets the docking station's device status recorded on your computer. Thereafter, you can dock your computer with the docking station at any time.

To dock the computer for the first time, do the following:

- 1** Install new devices in the docking station.
- 2** Connect the power cord to the docking station.
- 3** Slide the rear door at the rear of the computer and dock your computer to the docking station.

The  indicator appears on the docking station LCD, indicating that the computer is properly docked.

- 4** Turn on the computer.

Windows 95 begins to check the status of the docking station and restarts a couple of times. Follow the instructions that appear on the screen.

During this operation, Windows 95 creates a configuration profile for the docking station with the name *Dock X*.

Notes:

- a) X can be any number from 1 to 3. Your computer is capable of creating configuration information for three docking stations.
- b) The message "Version Conflict" might appear on the screen. Answer **Yes** to the prompt "Do you want to keep this file?"

5 In Windows 95, select **My Computer, Control Panel, System,** and then the **Hardware Profile** tab.

6 Make sure the new profile, Dock X, is created. Also, select the **Device Manager** tab and make sure that the new devices are displayed in the device list.

If Dock X is not created, repeat from step 1.

If the symbol “!” or “x” appears next to the device symbol, a resource conflict might have occurred. Resolve the problem by referring to “Resolving System Resource Conflicts” in the online book.

After the new hardware profile Dock X is created, you can dock or undock your computer to the docking station while the power is on.

Undocking with Your Computer Powered On or While in Suspend Mode

To undock your computer from the docking station when the computer is operating (or *hot undocking*) or when the computer is in suspend mode (or *warm undocking*), do the following:

1 Select **Start** in Windows 95, and then **Eject PC**. The LCD on your computer turns off and on.

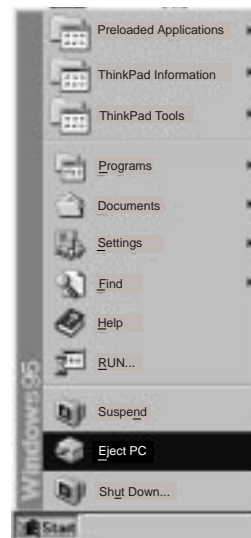

or

Turn the security key of the docking station to the rear, and remove the computer. You may have to push strongly.

An eject request is made to the operating system. It may take some time for this eject operation to end.

Note: To see if the eject operation is complete, click on **Start** again and see if the **Eject PC** icon still appears. If the icon still appears, wait until it disappears.

- 2** When you hear a beep, turn the security key to the rear again. Now you can eject your computer from the docking station.

Note: If the operating system rejects the eject request, a message appears on the screen. You should then try *cold undocking*.

Presetting a Device to Avoid a Resource Conflict

The Windows 95 plug and play function enables you to use devices that you install in the docking station immediately after you power on. If you cannot use them, a system resource conflict might have occurred. Do the following to resolve the conflict:

For a PCI adapter or an SCSI device:

1. Start the ThinkPad Configuration program and click on the **Docking Station** () button.
2. Assign at least one IRQ value. The default setting is IRQ 11.

For an ISA adapter card:

1. Open Windows 95 Device Manager and check the resources available for the new card.
2. Set the jumper or the DIP switches on the adapter card.

For an IDE device such as a hard disk drive or a CD-ROM drive:

1. Start the ThinkPad Configuration program and click on the **Docking Station** () button.
2. Add a checkmark on **Enable IDE device in the Docking Station**, if there isn't any, and restart the computer.

3. Click on **Device Manager** and check whether there is a resource conflict between the new IDE device and the other devices in the computer. If there is a resource conflict, go to “Resolving System Resource Conflicts” in the online book.

Using the Security System Lock

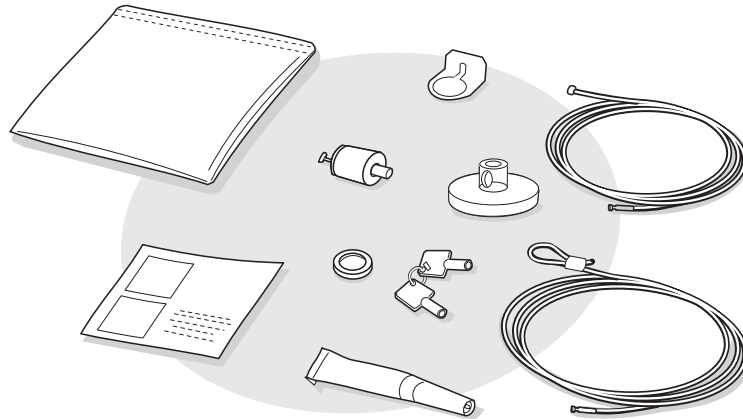

To prevent your computer from being stolen, you should purchase the optional security system lock from your dealer. You will be responsible for its evaluation, selection, and installation. IBM will not be held responsible for its functionality, quality, or performance.

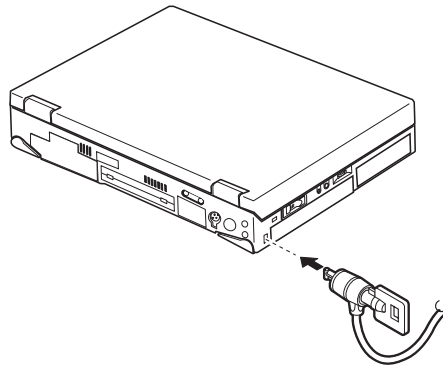

Refer to the instructions shipped with this option for how to use this security feature.

Attaching a Television to Your Computer

You can attach a television (NTSC or PAL) to your computer and display the computer screen on it.

To display the computer screen on television, do the following:

- 1 Turn off the computer and television.
- 2 Connect the video in-out cable 1 to the video-out port 2 (); then connect your television.

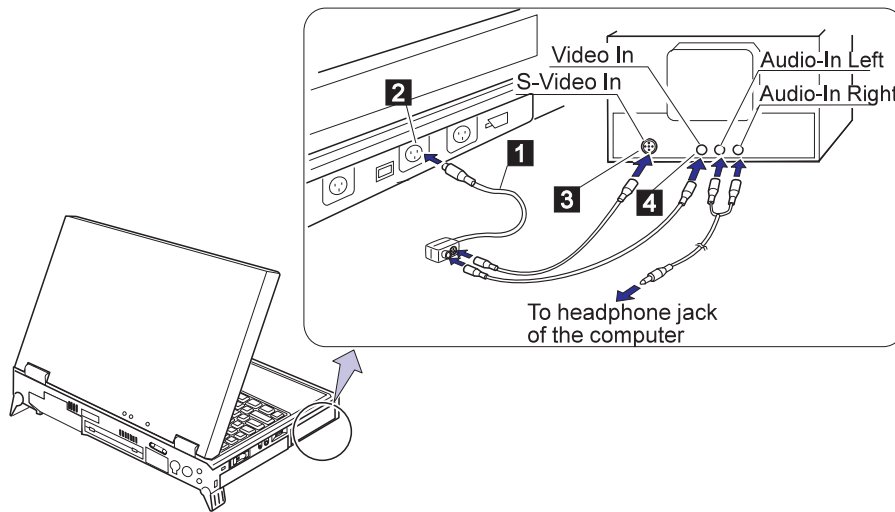

- 3 Enable the video-out port (TV out) in the “Enhanced Video/MPEG” window in the ThinkPad program.

Notes:

- a) Only the video in-out cable 1 is supplied with your computer. The other cables are not supplied; you must purchase them.
- b) If you are using a television with an S-video input, connect the video in-out cable to the S-video-in port 3 on your television for better picture quality.
- c) If you are using a television with non-S-video input, connect the video in-out cable to the normal television connector 4 on your television.



d) If your video equipment has only one audio-input connector, use the left-audio connector of the audio cable.





Chapter 4. Solving Computer Problems

Frequently Asked Questions	4-2
Troubleshooting Guide	4-3
Troubleshooting Charts	4-4
Error Codes or Screen Messages	4-5
No Error Codes or Screen Messages	4-10
An Input Problem	4-11
A Suspend or Hibernation Problem	4-12
An LCD Problem	4-16
An Indicator Problem	4-17
A Battery Problem	4-17
A CD-ROM Drive Problem	4-18
A DVD Problem	4-20
An Infrared Communication Problem	4-21
An Enhanced Video/MPEG Problem	4-22
An Audio or a Telephony Problem	4-22
A Universal Serial Bus (USB) Problem	4-23
A Modem Problem	4-23
Other PC Card Problems	4-26
A SelectaDock Problem	4-26
A Printer Problem	4-27
An External Display Problem	4-27
A Television Problem	4-29
Other Option Problems	4-29
A Software Problem	4-31
Other Problems	4-31
Testing Your Computer	4-32

Frequently Asked Questions

How can I expand my hard disk space?

Most preloaded applications in the hard disk can be uninstalled to make more room for other applications. Check whether the application you want to delete has its own deletion icon.

After you create the necessary driver diskettes using the Diskette Factory, delete the files.

How can I get the operating system or the device driver diskettes?

You can restore Windows 95 using the Recovery CD, which is shipped with your computer. For details, refer to the online book.

You can make a backup copy of your device drivers by using the Diskette Factory program as follows:

1. Click on **Start**,
2. Move the cursor on **ThinkPad Tool**.
3. Click on **Diskette Factory**.

How can I resolve a resource conflict (such as an IRQ or a COM port setting) occurring during the installation of a new option or a new application?

See "Resolving System Resource Conflicts" in the online book to obtain information on hardware resources used by the devices in the computer.

My computer does not perform as I expected.

Your computer's performance varies depending on the hardware and software installed, such as memory size, swapper file size, and smart drive settings.

Also, close all windows you are not using; for example, close the "Media Player" window when you play a CD in the CD-ROM drive.

Troubleshooting Guide

The following chart shows how to find or solve a problem.

When a beep sounds, when a message appears, or when a function-related problem occurs:

1 Find your symptom from the table and try solving your problem.

→ "Troubleshooting Charts" on page 4-4

2 If you can't solve the problem, run the test and make sure the hardware and the device drivers are OK.

→ "Testing Your Computer" on page 4-32

3 Write down the error code and let the servicer know the error; then request service.

→ Chapter 5

When you accidentally lose or damage software in your computer:

Recover it by using the Recovery CD or the Diskette Factory.

→ Refer to the section "Recovering Preloaded Software (for Windows 95 Only)" in the online book.

Troubleshooting Charts

If your computer has an error, it often displays a message or an error code, or a beep sounds when you power it on. Go through the charts and look for your problem. If you find your problem, go to the page indicated and do the specified action.

Troubleshooting Chart	Page
Error codes or screen messages	4-5
No error codes or screen messages	4-10
An input problem	4-11
A suspend or a hibernation problem	4-12
An LCD problem	4-16
An indicator problem	4-17
A battery problem	4-17
A CD-ROM problem	4-18
A DVD problem	4-20
An infrared communication problem	4-21
An enhanced video/MPEG problem	4-22
An audio or a telephony problem	4-22
A universal serial bus problem	4-23
A modem problem	4-23
Other PC Card problems	4-26
A SelectaDock problem	4-26
A printer problem	4-27
An external display problem	4-27
A television problem	4-29
Other option problems	4-29
A software problem	4-31
Other problems	4-31



Error Codes or Screen Messages



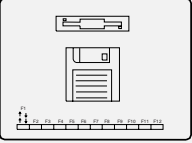
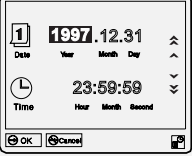
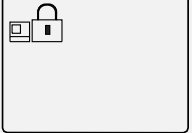

Note: In the charts, x can be any character.

Message	Action
I9990301 I9990302 I9990305 (incorrect connection of the hard disk drive may cause these error codes to appear.)	Your computer can't find the startup drive. Do the following: <ol style="list-style-type: none"> 1. Turn off the computer. 2. Press and hold F1; then turn on the computer to start Easy-Setup. Hold F1 until the Easy-Setup menu appears. 3. Select the Start up icon. If you are unable to set the startup sequence, have the computer serviced. 4. Check the devices in the startup sequence box. Is the default drive listed in the startup sequence box? Yes Exit this window, and turn off the computer. No Select the Reset icon. 5. Is an operating system installed? Yes Go to step 7. No Install the operating system in your computer. 6. After you install the operating system, turn off the computer. 7. Turn on the computer. If the same screen message appears, have the computer serviced.
I99xxxxx (except the above I999030x errors)	Have the computer serviced.
111 (docking station error)	If you are using a port replicator or a docking station, disconnect it; then reconnect it. If you still have a problem, refer to the manual shipped with your port replicator or docking station.

Message	Action
<p>158 (supervisor password error)</p>	<p>A hard disk drive was installed with a different supervisor password, or it did not have a hard disk password.</p> <p>The hard disk drive with the error can be in any of the following:</p> <ul style="list-style-type: none"> The main bay of your computer The UltraBay II The UltraBay II of the docking station attached to your computer. <p>To solve the problem, do the following:</p> <ol style="list-style-type: none"> 1. Make sure a hard disk drive without the error is installed in the main hard disk bay of your computer. <p>If the hard disk drive is installed in the UltraBay II of the docking station, turn off the computer and reinstall it into the main hard disk bay of your computer.</p> <ol style="list-style-type: none"> 2. Press Enter. 3. Type your supervisor password at the power-on password prompt. <p>If the 158 error appears, press Enter to proceed to the Easy-Setup "Password" submenu.</p> <ol style="list-style-type: none"> 4. Select the Supervisor icon; then press Enter. <p>The same password as the supervisor password is set for the hard disk password on the main hard disk bay.</p> <ol style="list-style-type: none"> 5. Turn off the computer.
<p>159 (supervisor password error)</p>	<p>The hard disk password differs from the supervisor password.</p> <p>The hard disk drive with the error can be in any of the following:</p> <ul style="list-style-type: none"> The main hard disk drive bay of your computer The UltraBay II The UltraBay II of the docking station attached to your computer <p>To solve the problem, do the following:</p> <ol style="list-style-type: none"> 1. Make sure the hard disk drive password and the supervisor password differ. <p>If the hard disk drive is in the UltraBay II of the docking station, turn off the computer and reinstall it into the main bay of your computer.</p> <ol style="list-style-type: none"> 2. Turn off the computer; then turn it on again. 3. Change the hard disk password to the supervisor password at the hard disk password prompt.

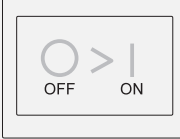
Message	Action
16x or 17x (undefined date or configuration error)	Follow the instructions on the screen.
174 (device configuration error)	Make sure that the hard disk drive and the device in the UltraBay II are firmly installed. Check the connection.
184 (invalid password error)	The password entered is invalid. Turn off the computer and wait at least 5 seconds; then turn it on again and type the correct password.
190 (critical low-battery error)	The computer turned off because the battery is low. Connect the AC Adapter to the computer and charge the battery pack, or replace the battery pack with the fully charged one.
195 (hibernation error)	The system configuration differs from the time your computer entered hibernation mode and after it exited this mode, and your computer cannot resume normal operation. Change the system configuration to what it was before your computer entered hibernation mode. If the memory size was changed, re-create the hibernation file.
196 (hibernation error)	The computer cannot read the hibernation file. Have the computer serviced.
2xx (memory error)	Make sure that the DIMM option is correctly installed.
30x (keyboard error)	Make sure that no object is placed on the keyboard or on the external keyboard, if you have one. Power off the computer and power off all attached devices. Power on the computer first; then power on the attached devices. If you still have a problem, do the following: If an external keyboard is connected, do the following: <ul style="list-style-type: none"> – Turn off the computer and disconnect the external keyboard; then turn on the computer. Make sure that your keyboard operation is correct. If it is, have the external keyboard serviced. – Make sure that the external keyboard is connected to the correct connector. Test the computer by selecting the Start icon in the Easy-Setup “Test” submenu. <ul style="list-style-type: none"> – If the computer stops during the test, have the computer serviced.

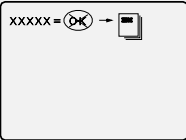
Message	Action
<p>Diskette and F1 prompts</p> 	<p>Make sure that the hard disk drive is correctly installed.</p> <p>Or, make sure that the self-starting diskette is inserted correctly (with the label facing up and metal-shutter end first) in the diskette drive.</p> <p>If it is, press F1. If both prompts remain, have the computer serviced.</p>
<p>A 163 error appears and then the <i>Date and Time</i> window appears.</p> 	<p>Neither the date nor the time is set in the computer.</p> <p>Set the date and time by typing or clicking on ▲ or ▼ to set the values; then click on OK.</p> <p>When both the power-on password and supervisor password are set, do the following:</p> <ol style="list-style-type: none"> 1. Power on the computer. The password prompt appears after the error code. 2. Type the supervisor password, not the power-on password. An error window appears. 3. Click on OK or press Enter. 4. Set the time and date in the next screen; then press Enter. The system reboots. <p>Note: If the power-on password is rejected, reset the power-on password using Easy-Setup if you need to.</p>
<p>The power-on password prompt</p> 	<p>A power-on password or supervisor password is set. Type the correct password and press Enter to use the computer (see page 2-16).</p> <p>If the power-on password is not accepted, a supervisor password may have been set. Type the supervisor password and press Enter.</p> <p>If you still have a problem, have the computer serviced.</p>
<p>The hard disk password prompt</p> 	<p>A hard disk password is set. Type the correct password and press Enter to use the computer (see page 2-16).</p> <p>If you still have a problem, have the computer serviced.</p>

Message	Action
<p>The "Test" submenu</p> 	<p>Select the Start icon and follow the instructions to test your system.</p> <p>If you cannot complete the test, have the computer serviced.</p> <p>If the test does not find the problem, but the problem persists nonetheless, go through the Troubleshooting Charts one by one.</p> <p>If the test ends in an error, note the error code and have the computer serviced.</p>
	<p>This screen appears when you reboot your computer and after you change the IDE channel from 2 to 3.</p> <p>Turn off the computer and wait at least 5 seconds; then turn it on again.</p>
<p>A POST error prompt</p> 	<p>An error was found during POST. Press Enter; then select Start from the "Test" submenu and run the test.</p> <p>If the test ends in an error, note the error code and have the computer serviced.</p>
<p>An error prompt</p> 	<p>Turn off the computer and start Easy-Setup; then select Test to test the computer.</p> <p>If the test ends in an error, note the error code and have the computer serviced.</p> <p>You can start the operating system by pressing F1 instead, and ignore the error.</p>
<p>The DOS full-screen looks smaller.</p> 	<p>When you use a DOS application that supports only the 640x480 resolution (VGA mode), the screen image might look slightly distorted or might appear smaller than the display size. This is to maintain compatibility with the other DOS applications. To expand the screen image to the same size as the actual screen, start the ThinkPad Configuration program and click on LCD (); then select the Screen expansion function. (The image may still look slightly distorted.)</p> <p>Note: You can use the Fn+F8 keys to do the same thing.</p>
<p>A panel or message that is not listed.</p>	<p>Turn off the computer and start Easy-Setup; then select Test to test the computer.</p> <p>If the test ends in an error, note the error code and have the computer serviced.</p> <p>If you cannot start Easy-Setup, have the computer serviced.</p>

Message	Action
xxxxx KB OK appears and the computer stops.	Have the computer serviced.

No Error Codes or Screen Messages

Problem	Action
<p>The screen is blank and you don't hear any beeps.</p> <p>Note: If you are not sure whether you heard any beeps or not, turn the computer off; then turn it on again, and listen again.</p>	<p>Make sure that:</p> <ul style="list-style-type: none"> The battery pack is installed correctly. The AC Adapter is connected to the computer and the power cord is plugged into a working electrical outlet. The computer power is on. (Turn on the power switch again for confirmation.) <p>If these items are correct and the screen remains blank, have the computer serviced.</p>
<p>The screen is blank and you can't hear any beeps.</p> <p>Note: If you are using an external display, go to "An External Display Problem" on page 4-27.</p>	<p>If a power-on password is set, press any key to display the power-on password prompt, and then type the correct password and press Enter (see page 2-16).</p> <p>If the power-on password does not appear, the brightness control lever might be set to minimum brightness. Adjust the brightness level. If the screen still remains blank, have the computer serviced.</p>
<p>The screen is blank and you hear a continuous beep, or two or more beeps.</p>	<p>Have the computer serviced.</p>
<p>Only the cursor appears.</p>	<p>Reinstall your operating system and turn on the computer.</p> <p>If you still have a problem, have the computer serviced.</p>





An Input Problem

Problem	Action
The pointer does not move after the computer awakens from one of the power-saving modes.	Make sure you followed the instructions in the online book correctly when you installed Windows with the Advanced Power Management (APM) option.
All or some keys on the keyboard do not work.	<p>If the problem occurred immediately after the computer returned from suspend mode, enter the power-on password if it is set.</p> <p>If an external keyboard is connected, the numeric keypad on your computer will not work. This is not a defect.</p> <p>If an external numeric keypad or a mouse is connected:</p> <ol style="list-style-type: none"> 1. Turn off the computer. 2. Remove the external numeric keypad or the mouse. 3. Turn on the computer and try using the keyboard again. <p>If the keyboard problem is resolved, check the connection of the external numeric keypad, external keyboard, or the mouse.</p> <p>If you still have a problem, have the computer serviced.</p>
The pointer drifts when the computer is turned on or after it resumes normal operation.	<p>The pointer may drift when you are not using the TrackPoint during normal operation. This is a normal characteristic of the TrackPoint and is not a defect. Pointer drifting may occur for several seconds under the following conditions:</p> <ul style="list-style-type: none"> When the computer is turned on. When the computer resumes normal operation. When the TrackPoint is pressed for a long time. When the temperature changes.
The mouse or pointing device does not work.	<p>Make sure that the mouse or pointing-device cable is securely connected to the computer.</p> <p>Try using the TrackPoint. If the TrackPoint works, the error might be due to the mouse.</p> <p>If your mouse is incompatible with the IBM PS/2 mouse, disable the TrackPoint using the ThinkPad Configuration program.</p> <p>Note: See the manual supplied with the mouse for more information.</p>
The mouse buttons don't work.	Change the mouse driver to Standard PS/2 Port Mouse , and then change to PS/2 TrackPoint .
The Scrolling or Magnifying Glass function doesn't work.	<p>See the General tab page in "Mouse Properties," and make sure that the PS/2 TrackPoint driver is loaded.</p> <p>Note: Refer to the README file in the TrackPoint driver diskette for driver installation.</p>



Problem	Action
A number appears when you type a letter.	The numeric lock function is on. To disable it, press and hold Shift ; then press NumLk .

A Suspend or Hibernation Problem

Problem	Action
The computer enters suspend mode automatically.	The computer enters suspend mode automatically when the processor temperature reaches a certain level. This is not a defect.
Performance degrades when the computer gets hot during use.	The processor speed might decrease under the following conditions: Use in a hot environment High-powered processing that requires high-power consumption This is not a defect.
The computer enters suspend mode immediately after POST (the suspend lamp turns on).	Make sure that: The battery pack is charged. The operating temperature is within the acceptable range. Refer to Appendix A. If these items are correct, have the computer serviced.
Error 19 appears and the computer immediately turns off.	The battery pack power is getting low. Connect the AC Adapter to the computer, or replace the battery pack with a fully charged one.
The computer does not return from suspend mode, or the suspend lamp stays on and the computer does not work.	The computer automatically enters suspend or hibernation mode when the battery power is empty. Do one of the following: Replace the battery pack with a fully charged one and then press Fn . Connect the AC Adapter to the computer; then press Fn .

Problem	Action
Your computer does not enter suspend or hibernation mode.	<ol style="list-style-type: none">1. Check if the suspend or hibernation mode is disabled.2. If your computer is docked to the SelectaDock and a network card is installed, or if you are using the AC Adapter and your computer is connected to a network, do the following: Windows 95:<ol style="list-style-type: none">a) Click on Start.b) Move the cursor to Programs and ThinkPad; then click on ThinkPad Configuration.c) Click on Docking Station ().d) Make sure that hibernation mode is enabled.Windows NT:<ol style="list-style-type: none">a) Click on Start.b) Move the cursor to Programs and ThinkPad; then click on ThinkPad Configuration.c) Click on Docking Station ().d) Click on Power Management ().e) Click on the Suspend/Hibernation/Resume Options ().f) Make sure that Suspend/hibernate while docking is selected.g) Click on OK.

Problem	Action
<p>The computer does not enter suspend mode as set by the timer under Windows 95 or Windows NT.</p>	<p>For Windows 95:</p> <p>The Windows 95 generic CD-ROM driver accesses the internal CD-ROM drive every 3 seconds to see if a CD-ROM is inserted in the CD-ROM drive. This prevents your computer from entering suspend mode even after a timeout.</p> <p>To prevent this from occurring, do the following:</p> <ol style="list-style-type: none">1. Double-click on My Computer, Control Panel, and System.2. Click on the Device Manager tab.3. Click on the + mark of CD-ROM.4. Double-click on the CD-ROM name.5. Click on the Setting tab.6. Remove the check mark from Auto insertion notification. <p>Windows 95 no longer detects the CD-ROM insertion automatically.</p> <p>For Windows NT:</p> <p>The computer does not enter suspend mode by the timer if you enable the CD-ROM AutoRun feature. To enable the Suspend Timer function in the registry, do the following:</p> <pre>HKEY_LOCAL_MACHINE\SYSTEM\CurrentControlSet\Services\Cdrom\ Autorun: x1 → Autorun:</pre>

Problem	Action
<p>The computer does not enter hibernation mode with the Fn+F12 key combination.</p>	<p>Enable hibernation mode as follows:</p> <p>For Windows 95:</p> <ol style="list-style-type: none"> 1. Click on Start. 2. Move the cursor to Programs and ThinkPad; then click on ThinkPad Configuration. 3. Click on Power Management (). 4. Click on the Hibernation tab. 5. Click on Enable Hibernation. <p>Note: If you have already created the hibernation file, this button is displayed in gray and you cannot click on it.</p> <ol style="list-style-type: none"> 6. Click on Create Now. 7. Click on OK. <p>The computer cannot enter hibernation mode when you are using one of the IBM communication PC Cards.</p> <p>To enter hibernation mode, stop the communication program, and then remove the PC Card or turn off power on the PC Card slot using the Control Panel.</p> <p>For Windows NT:</p> <p>Note: You must format your hard disk with the FAT format system to use hibernation mode in Windows NT. When you format your hard disk with NTFS, the Windows NT default format, you will not be able to use hibernation mode.</p> <ol style="list-style-type: none"> 1. Click on Start. 2. Move the cursor to Programs and ThinkPad; then click on ThinkPad Configuration. 3. Click on Power Management (). 4. Click on Suspend/Hibernation/Resume Options (). 5. Select the option you want to enable and add a check mark (<input type="checkbox"/>) by clicking on the box. 6. Click on OK. <p>The computer cannot enter hibernation mode when you are using one of the IBM communication PC Cards.</p>

An LCD Problem

Problem	Action
The screen is unreadable or distorted.	<p>Make sure that:</p> <p>The display driver is installed correctly by doing the following:</p> <ol style="list-style-type: none"> 1. Double-click on My Computer, Control Panel, and then Display 2. Select the Settings tab. 3. Click on Advanced Properties. The "Adapter/Driver Information" window appears. Make sure the display driver information in the window is correct. <p>The refresh rate setting is set to your display resolution and color depth by doing the following:</p> <ol style="list-style-type: none"> 1. Click on Start. 2. Move the cursor to Programs and ThinkPad; then click on ThinkPad Configuration. 3. Click on LCD (. 4. (For Windows 95) Click on Properties... (For Windows NT) Click on Advanced... 5. Make sure that the setting in the next window is correct. 6. Click on OK.
Incorrect characters appear on the screen.	<p>Did you install the operating system or application program correctly?</p> <p>If they are installed and configured correctly, have the computer serviced.</p>
The screen stays on even after you power off your computer.	<p>Press the reset switch with the tip of a pen and turn off your computer; then turn it on again.</p>
Missing, discolored, or bright dots appear on the screen every time you power on your computer.	<p>This is not a problem. It is an intrinsic characteristic of the TFT technology. Your computer display contains multiple thin-film transistors (TFTs). A small number of missing, discolored, or bright dots on the screen may exist all the time.</p>

An Indicator Problem

Problem	Action
The battery status indicator does not go on even though a battery pack is installed in the computer.	The over-current protection device inside the battery pack has been activated. Wait several hours and try again. If the indicator does not appear, replace the battery pack or have the computer serviced.
The diskette-drive-in-use icon stays on.	<p>If a diskette is in the drive, make sure that:</p> <ul style="list-style-type: none"> – The internal or externally diskette drive is firmly connected to the computer. – The diskette contains the necessary files to start the system. – There is nothing wrong with your application program. – There is nothing wrong with the diskette. – The diskette is inserted correctly (label facing up and the metal-shutter end first) in the diskette drive. <p>If these items are correct, have the computer serviced. If there is no diskette in the drive, have the computer serviced.</p>

A Battery Problem

Problem	Action
The battery pack cannot be fully charged in 3 hours by the power-off charging method.	<p>The battery pack might be over-discharged. Do the following:</p> <ol style="list-style-type: none"> 1. Turn off the computer. 2. Make sure that the over-discharged battery pack is in the computer. 3. Connect the AC Adapter to the computer and let it charge. <p>If the battery pack cannot be fully charged in 24 hours, use a new battery pack. If the optional Quick Charger is available, use it to charge the over-discharged battery pack.</p>
<p>Your computer shuts down before the battery status indicator shows empty,</p> <p>–or–</p> <p>Your computer operates after the battery status indicator shows empty.</p>	Repeat discharging and charging the battery pack at least three times.

Problem	Action
The operating time for a fully charged battery pack is short.	Repeat discharging and charging of the battery pack three to six times. If you still have a problem, use a new battery pack.
The computer does not operate with a fully charged battery pack.	The over-current protective function in the battery pack might be activated. Turn off the computer for 1 minute to reset this function; then turn it back on again.

A CD-ROM Drive Problem

Problem	Action
The CD-ROM does not work.	<p>Make sure that:</p> <ul style="list-style-type: none"> The computer power is turned on and a compact disc is in the CD-ROM drive. The CD-ROM drive connector is firmly connected to the computer. The CD-ROM drive tray is firmly closed. The device drivers are correctly installed. <p>If the CD-ROM drive in the docking station does not work, do the following:</p> <ol style="list-style-type: none"> 1. Click on Start. 2. Move the cursor to Programs and ThinkPad; then click on ThinkPad Configuration. 3. Click on Docking Station (). 4. Make sure that you checked Enable IDE device in the docking station. <p>Note: Do not use IRQ 11 and 15 for the PCI device setting.</p> <ol style="list-style-type: none"> 5. Click on OK.
You hear a noise from the CD-ROM drive when the CD-ROM is spinning.	The CD-ROM drive cover might be bent. Have the CD-ROM drive serviced.
The CD-ROM tray does not open even if you press the CD-ROM eject button.	Insert a pin into the CD-ROM emergency eject hole and eject the CD-ROM tray.

Problem	Action
The compact disc cannot be read.	<p>Make sure that:</p> <ul style="list-style-type: none">The compact disc is not dirty. If it is, clean it with a CD-ROM cleaner kit.The compact disc is not defective. If it is, try another compact disc.The compact disc is placed in the tray with the label side up.The compact disc format conforms with one of the following:<ul style="list-style-type: none">- Music CD- CD-ROM or CD-ROM XA- Multisession photo CD- Video CD and CD-i movie (Windows 95 does not support CD-i movies)

A DVD Problem

Problem	Cause and Action
The DVD does not work.	<p>Make sure that:</p> <ul style="list-style-type: none"> The computer power is turned on and a DVD disc or a compact disc is in the DVD drive. The DVD drive connector is firmly connected to the computer. The DVD drive tray is firmly closed. The device drivers are correctly installed. <p>If the DVD drive in the docking station does not work, do the following:</p> <ol style="list-style-type: none"> 1. Click on Start. 2. Move the cursor to Programs and ThinkPad; then click on ThinkPad Configuration. 3. Click on Docking Station () 4. Make sure that you checked Enable IDE device in the docking station. <p>Note: Do not use IRQ 11 and 15 for the PCI device setting.</p> <ol style="list-style-type: none"> 5. Click on OK.
You hear a noise from the DVD drive when the DVD disk or compact disk is spinning.	The DVD drive cover might be bent. Have the DVD drive serviced.
The DVD tray does not open even if you press the DVD eject button.	Insert a pin into the DVD emergency eject hole and eject the DVD tray.
The DVD disc or compact disc cannot be read.	<p>Make sure that:</p> <ul style="list-style-type: none"> The DVD disc or compact disc is not dirty. If it is, clean it. The DVD disc is not defective. If it is, try another DVD disc. The DVD disc is placed in the tray with the label side up. <p>The DVD disc format conforms with one of the following:</p> <ul style="list-style-type: none"> – Music CD – CD-ROM or CD-ROM XA – Multisession photo CD – Video CD and CD-i movie (Windows 95 does not support CD-i movie) – DVD-ROM (DVD-video) – DVD-movie with MPEG hardware and software

An Infrared Communication Problem

Problem	Action
<p>Your computer cannot communicate with other devices using the infrared port.</p>	<p>Make sure that:</p> <ul style="list-style-type: none"> The communication speeds are the same. The infrared ports are clean and do not have any spots. No objects are between the computer and the communicating device. The distance and angle between the computer and the communicating device is within the acceptable range. Move the computer or device; then try the communication again. The communicating distance might be less if: <ul style="list-style-type: none"> – The other computer is not the same model as yours. – There is interference from ambient light. You should not use infrared communication under direct sunlight or under artificial lighting conditions. – The infrared port is not directly facing the other communicating port. <p>Communication can be affected by the light from the display on the computer. To avoid this from happening, open the display to a wide angle. The same communication application has to be run on your computer and the communicating computer. Refer to the application manuals for more information.</p> <p>ThinkPad mode cannot be used if you are using a conventional communication application that uses the serial port and cable for data exchange. In this case, the infrared port is just a substitute for them.</p>
<p>Incorrect data is sent between your computer and a communicating device.</p>	<p>Make sure that:</p> <ul style="list-style-type: none"> The distance and angle between your computer and the device is within the set range. The communication speeds are the same. There are no other devices that radiate infrared rays, such as remote-controlled devices or wireless headphones, near your computer or the communicating device. You are not operating under direct sunlight. No fluorescent lamps are near your computer or the communicating device.

An Enhanced Video/MPEG Problem

Problem	Cause and Action
<p>The Enhanced Video function or the MPEG function does not work.</p>	<p>Make sure there are no resource conflicts (IRQ or I/O address). Enable the Enhanced Video/MPEG function by doing the following:</p> <ol style="list-style-type: none"> 1. Click on Start. 2. Move the cursor to Programs and ThinkPad; then click on ThinkPad Configuration. 3. Click on Enhanced Video/MPEG (. 4. Make sure that at least one IRQ is assigned for the PCI devices. <p>If you find a conflict with other devices, change the IRQ value. (see "Resolving System Resource Conflicts" in the online book).</p> <p>The MPEG playback and the video capture functions use the same hardware resources. Only one of the two functions can be used at one time. Likewise, two MPEG functions cannot be used at the same time.</p>

An Audio or a Telephony Problem

Problem	Cause and Action
<p>The volume of the WaveTable MidiSynth device cannot be controlled.</p>	<p>Use the Serial-in control in the volume control panel to control the volume.</p>
<p>The voice quality over the Voice-Over-Data communication is poor.</p>	<p>Due to limitations of the ThinkPad Modem, the voice quality that is transmitted and received over the Voice-Over-Data communication is not as good as the normal telephone line. There may be momentary voice discontinuities, delays, or distortions.</p>
<p>Other problems.</p>	<p>Problems may be due to such other factors as:</p> <ul style="list-style-type: none"> Incompatibility between the ThinkPad Modem feature and other adapter cards in the docking station. To isolate this problem to a card or device, remove the adapter cards in the docking station one by one, and run the Easy-Setup "Test" submenu. The telephone cable configuration is not correct for your application. The telephone cable is defective. The telephone is defective. The audio cable configuration is not correct for your application. The audio cable is defective. The audio equipment is defective.

A Universal Serial Bus (USB) Problem

Problem	Cause and Action
A device connected to the USB port does not work.	<p>For Windows 95, make sure that:</p> <ol style="list-style-type: none"> 1. The USB device is connected correctly. 2. Open the "Device Manager" window, and make sure that the USB device setup is correct, and that computer resource assignment and device driver installation are correct. <p>Note: To open the "Device Manager" window, double-click on My Computer, Control Panel, and System. Then click on the Device Manager tab in the "System Properties" window.</p> <p>Refer to "Testing Your Computer" on page 4-32 and run the diagnostic test for the USB port.</p>

A Modem Problem

Problem	Action
The internal modem does not work when you boot your computer from an operating system other than Windows 95.	<p>The operating system may be sharing the same IRQ levels as your modem. The ThinkPad Modem software might not work under these conditions. You must cancel the IRQ shared condition to use the modem.</p> <p>Refer to the online book to cancel the IRQ shared condition.</p>

Problem	Action
<p>My modem application does not work with the ThinkPad Modem.</p>	<p>Make sure that the internal modem port is enabled by opening the “Device Manager” window and running the Modem Wizard or by opening the ThinkPad Configuration program and doing as follows:</p> <ol style="list-style-type: none"> 1. Click on Start. 2. Move the cursor to Programs and ThinkPad; then click on ThinkPad Configuration. 3. Click on Internal Modem (). 4. Select Enable. 5. Click on OK. <p>For Windows 95</p> <p>If the modem does not work correctly, go to “Resolving System Resource Conflicts” in the online book.</p> <p>If the modem works correctly, set the following modem settings by doing the following:</p> <ol style="list-style-type: none"> 1. Double-click on My Computer, Control Panel, and Modem. The OEM Mig 33.6 Data Fax VOD Modem is highlighted. 2. Click on Properties, not Dialing Properties. 3. Click on the Connection tab. 4. If there is a check mark (<input checked="" type="checkbox"/>) in the Wait for dial tone before dialing box, click and remove it. 5. Click on Advanced. 6. If there is a check mark (<input checked="" type="checkbox"/>) in the Use error control box, click and remove it. 7. Add a check mark (<input type="checkbox"/>) to the Use flow control by clicking on the box and make sure that the Hardware (RTS/CTS) is selected. 8. Click on OK to close the window. 9. Click on OK and return to the “Modem Properties” window. 10. Click on Dialing Properties and fill in all boxes and click on either Tone dialing or Pulse dialing. <p>Note: Most telephones today use tone dialing, where each button produces a different tone, instead of pulse dialing.</p> <ol style="list-style-type: none"> 11. Click on OK. 12. Click on Close to close the window. 13. Close all active windows. <p>Run your modem application again.</p>

Problem	Action
My PC Card modem does not work	<p>Make sure that the infrared port is disabled and the modem is set up correctly. You can disable the infrared port from the ThinkPad Configuration program or the "Device Manager" window.</p> <p>Open the ThinkPad Configuration program and do as follows:</p> <ol style="list-style-type: none"> 1. Click on Start. 2. Move the cursor to Programs and ThinkPad; then click on ThinkPad Configuration. 3. Click on Infrared (). 4. Select Disable. 5. Click on OK. <p>For Windows 95</p> <p>To set up the modem, do the following:</p> <ol style="list-style-type: none"> 1. Double-click on My Computer, Control Panel, and then Modem. The "Modem Properties" window appears. 2. Make sure the PC Card (PCMCIA) modem is in the window. 3. Click on Properties, <i>not Dialing Properties</i>. 4. Click on the Connection tab. 5. Remove the check mark () in the Wait for dial tone before dialing box if it is checked. 6. Click on Advanced. 7. If there is a check mark () in the Use error control box, click and remove it. 8. Add a check mark () to the Use flow control by clicking on the box and make sure that the Hardware (RTS/CTS) is selected. 9. Close the window by clicking on OK. 10. Return to the "Modem Properties" window by clicking on OK. 11. Click on Dialing Properties in the "Modem Properties" window, and fill in all boxes. <p>Note: Click on either Tone dialing or Pulse dialing. Most telephones today use tone dialing.</p> <ol style="list-style-type: none"> 12. Click on OK. 13. Click on Close to close the window. 14. Close all active windows. <p>Run your modem application again.</p>

Other PC Card Problems

Problem	Action
The PC Card shows "Ready," but it does not work correctly.	<p>Make sure that:</p> <p>The system resources reserved for the PC Card do not conflict with other system devices.</p> <p>Refer to "Resolving System Resource Conflicts" in the online book.</p> <p>The resources reserved for the PC Card match the settings in the application program.</p> <p>If you are using a modem card, check the COM number, I/O port address, and IRQ level. If you are using a network card, check the I/O port address, IRQ level, and memory window address. To check the resources assigned to the PC Card, click on Status in the Easy-Setup program.</p>
A system resource conflict occurred when a PC Card was used.	See "Resolving System Resource Conflicts" in the online book.
The screen looks busy or the overlay position is shifted.	<ol style="list-style-type: none"> 1. Run VPMADJ.EXE in the Windows directory. 2. Adjust the x and y positions.



A SelectaDock Problem



Problem	Action
The IDE CD-ROM drive or the hard disk drive in the docking station does not work.	<p>Make sure that the system resources of the secondary IDE device in the docking station do not conflict with the system resources of the other devices. Do the following:</p> <ol style="list-style-type: none"> 1. Click on Start. 2. Move the cursor to Programs and ThinkPad; then click on ThinkPad Configuration. 3. Click on Docking Station  and put a check mark (<input checked="" type="checkbox"/>) on Enable IDE device in the docking station. <p>Note: Do not use IRQ 11 and 15 for the PCI device setting.</p> <ol style="list-style-type: none"> 4. Click on OK.

A Printer Problem

Problem	Action
The printer does not work.	<p>Make sure that:</p> <p>The parallel port is enabled.</p> <ol style="list-style-type: none"> 1. Click on Start. 2. Move the cursor to Programs and ThinkPad; then click on ThinkPad Configuration. 3. Click on Parallel Port (). 4. Select Enable. 5. Click on OK. <p>The printer is turned on and ready to print. The printer signal cable is connected to the correct connector of your computer.</p> <p>If these items are correct and the printer still does not work, run the tests described in the printer manual. If the tests show that the printer is OK, have the computer serviced.</p>

An External Display Problem

Problem	Action
The external display is blank.	<p>Do the following:</p> <ol style="list-style-type: none"> 1. Connect the external display to another computer to make sure it works. 2. Reconnect the external display to your computer. 3. Click on Start. 4. Move the cursor to Programs and ThinkPad; then click on ThinkPad Configuration. 5. Click on External Display () or LCD + External Display () on the toolbar in the ThinkPad Configuration. <p>If nothing appears on the external display, have the external display serviced.</p>

Problem	Action
<p>You cannot set a higher resolution than the present one on your external display.</p>	<p>Make sure that:</p> <p>The ThinkPad display driver is installed correctly by doing the following:</p> <ol style="list-style-type: none"> 1. Double-click on My Computer, Control Panel, and then Display. 2. Select the Settings tab in the "Display Properties" window. 3. Click on Advanced Properties. The "Adapter/Driver Information" window appears. Make sure that the ThinkPad display driver is installed. <p>If you are not sure that the ThinkPad display driver is installed correctly, reinstall it.</p> <p>An appropriate display type or refresh rate is selected.</p> <ol style="list-style-type: none"> 1. Click on Start. 2. Move the cursor to Programs and ThinkPad; then click on ThinkPad Configuration. 3. Click on LCD (. 4. (For Windows 95) Click on Properties.... (For Windows NT) Click on Advanced.... 5. Make sure the setting in the next window is correct. 6. Click on OK to close the window.
<p>The screen is unreadable or distorted.</p>	<p>Make sure that:</p> <p>The ThinkPad display driver is installed correctly by doing the following:</p> <ol style="list-style-type: none"> 1. Double-click on My Computer, Control Panel, and then Display. 2. Select the Settings tab in the "Display Properties" window. 3. Click on Advanced Properties. The "Adapter/Driver Information" window appears. Make sure that the ThinkPad display driver is installed. <p>The display is set correctly.</p> <ol style="list-style-type: none"> 1. Click on Start. 2. Move the cursor to Programs and ThinkPad; then click on ThinkPad Configuration. 3. Click on LCD (. 4. (For Windows 95) Click on Properties.... (For Windows NT) Click on Advanced.... 5. Make sure the setting in the next window is correct. 6. Click on OK to close the window. <p>If the settings are correct, run the tests described in the manual supplied with the external display. If the tests show that the external display is OK, have the computer serviced.</p>



Problem	Action
Wrong characters appear on the screen.	Did you install the operating system or application program with the correct procedure? If you did, have the external display serviced.

A Television Problem

Problem	Action
The screen is blank.	Even if you select the television for the external display () in the ThinkPad program, the LCD <i>always</i> turns on first when you power on your computer. Press the Fn+F7 keys to switch to the television.

Other Option Problems

Problem	Action
An IBM option that you just installed does not work.	Make sure that: <ul style="list-style-type: none"> The option is designed for your computer. The option was installed following to the instructions supplied with the option or this book. Other installed options or cables are not loose. There is no I/O address or interrupt level (IRQ) DMA channel conflict. To see the system resource status, start the ThinkPad Configuration program and click on the respective device buttons. <p>If the test program for the option did not find the problem, have the computer and option serviced.</p>
An IBM option that used to work no longer works.	Make sure that: <ul style="list-style-type: none"> The option is securely connected to your computer. If the option came with its own test instructions, use those instructions to test the option. There is no system resource conflict (see "Resolving System Resource Conflicts" in the online book). <p>If these items are correct and the test program did not find the problem, have the computer and option serviced.</p>

Problem	Action
The serial port does not work.	<p>Make sure that the serial port is enabled by doing the following:</p> <p>For Windows 95:</p> <ol style="list-style-type: none">1. Click on Start.2. Move the cursor to Programs and ThinkPad; then click on ThinkPad Configuration.3. Click on Serial Port ().4. Select Enable.5. Click on Device Manager.6. Set up the port in the "Device Manager" window.7. Click on OK. <p>For Windows NT:</p> <ol style="list-style-type: none">1. Click on Start.2. Move the cursor to Programs and ThinkPad; then click on ThinkPad Configuration.3. Click on Serial Port ().4. Select Enable; then select COM1, COM2, COM3, or COM4.5. Click on OK.

A Software Problem

Problem	Action
An application does not run correctly.	<p>Check the following to make sure that the problem is not being caused by the application:</p> <ul style="list-style-type: none"> Your computer has the minimum required memory to run the application. Refer to the manuals supplied with the application. The application is designed to operate with your operating system. Other applications run correctly on your computer. The necessary device drivers are installed (see the online book). The application works OK when it is run on some other computer. <p>If an error message appeared when you were using the application program, refer to the manuals supplied with the application.</p> <p>If these items are correct and you still have a problem, contact your place of purchase or the service representative for help.</p>
You cannot install OS/2 Warp.	See the online book.

Other Problems

Problem	Cause or Action
The computer locks or does not accept any input.	<p>Your computer might lock when it enters suspend mode during a communication operation. You should disable the Suspend Timer when you are working on the network.</p> <p>When you turn on the computer with OS/2 Warp installed, make sure no compact disc (CD) is in the CD-ROM drive. If there is, remove the CD, turn off the computer, and turn it on again.</p> <p>To turn the computer, press the reset switch using the tip of a ballpoint pen.</p>
The computer does not turn off with the power switch.	<p>If the suspend lamp is on and you are working under battery power, change the battery to a fully charged one or change your power source to ac power.</p> <p>If you still have a problem, press the reset switch using the tip of a ballpoint pen.</p>
The computer does not start from a diskette.	Make sure that the startup sequence in Easy-Setup is set so that the computer boots from the diskette drive (see page 2-57).

Testing Your Computer

If you still have a problem with your computer after using the Troubleshooting Charts, test the computer using the **Test** function of Easy-Setup.

To test your computer, do the following:

- 1 Make sure that the speaker volume control is in the middle position.
- 2 Press and hold **F1**; then turn on the computer to start Easy-Setup. Hold **F1** until the following Easy-Setup menu appears:

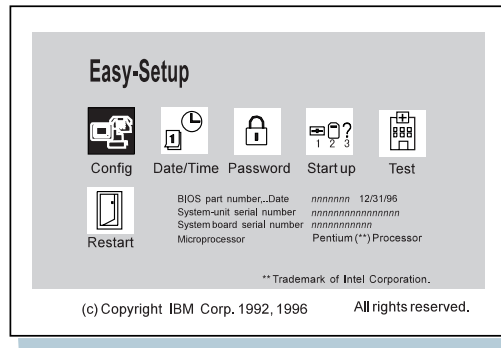

You will hear a short beep. If you are not sure whether you heard a beep or not, turn off the computer and try again. If you still don't hear a beep, the speaker is not working. Have your computer serviced.

3 Select the **Test** icon; then select the **Start** icon or press **Enter**.

Note: Do not touch the keyboard or the pointing device during the test.

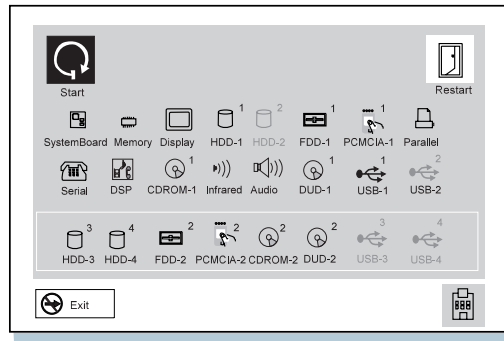

If you cannot go to the next menu, have your computer serviced.

If an X appears to the left of a device and an error code appears below it, write down the error code on a piece of paper and tell it to the person who will be repairing your computer.



Chapter 5. Getting Service

Preparation

If you need further assistance, call your IBM authorized reseller or IBM marketing representative.

You will need to know the following information when requesting repair service:

- Identification number
- Installed options in your system

Note: Use the checklist on page 5-2.

- Error message or problem

Note: Error messages can help identify what service action is required and help the service representative provide quick and efficient service.

Use the record sheet on page 5-3

Important

You may have to bear the cost of repair even during the warranty period if the product damage was due to misuse, accident, modification, unsuitable physical or operating environment, or improper maintenance.

For your convenience, write the service phone numbers here.

Information on Your ThinkPad

Option List

DIMM

Slot 1 (front) _____ MB
Slot 2 (rear) _____ MB

_____ MB Hard Disk Drive

Internal Diskette Drive

PC Cards

Option in the UltraBay II

Battery Pack

Identification Numbers

The serial number label is located on the bottom of your computer. Write down the Machine **Type** and the Serial Number **S/N** into the following box:

IBM Product Name	ThinkPad 770_____
Machine Type	_____
Serial Number	_____

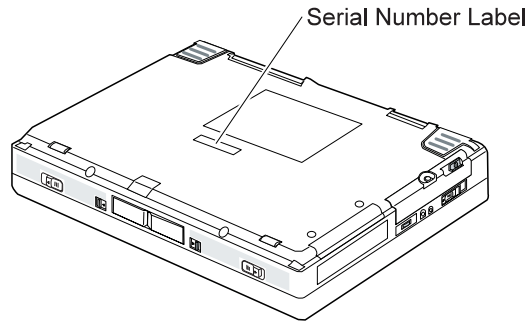

Problem Recording Sheet

Computer information:

Machine type: _____

Serial number: _____

Date of purchase: ___/___/___

Type of problem:

Continuous problem

Intermittent problem

Error code:

The operating system and its version number, if available:

DOS Version _____

Windows 3.1

Windows NT Version _____

OS/2 Version _____

Windows 95

Application programs running at the time of the problem:

Problem symptom:

Describe the problem more specifically.

Can it be reproduced?:

Yes No

If yes, describe how it can be reproduced:

How to Receive Customer Support and Service

Purchasing an IBM PC hardware product entitles you to receive support and services during the warranty period. If you need additional support and services, a wide variety of extended solutions that addresses most needs are available for purchase.

Help by Telephone

You can get support and information by telephone during the warranty period at no additional charge, through the IBM PC Support Line. Experienced technical-support representatives will be on hand to assist you in answering any questions you might have, such as:

- How to set up your computer
- How to install and set up your IBM options purchased directly from IBM or through an IBM reseller
- How to use the 30-day support for the preloaded operating system
- How to get service

Please have the following information ready when you call:

- Serial number of your computer and proof of purchase
- Description of the problem
- Exact wording of the error message
- Hardware and software configuration information for your system

If possible, be at your computer when you call:

- In the U.S. and Puerto Rico, call 1-800-772-2227.
- In Canada, call 1-800-565-3344.

These lines are available 24 hours a day, 7 days a week. The answering technical-support representative can also fax or mail you technical or product information, such as:

- Sales information
- Product brochures
- Location of IBM resellers
- Services available from IBM

ThinkPad EasyServ

ThinkPad *EasyServ* is a courier repair service for IBM mobile products wherein your ThinkPad computer will be picked up, sent to IBM for repair, and then returned to the location of your choice. This service is available at no additional charge during the warranty period. Most computers can be repaired the day that it arrives at the IBM repair location.

Support personnel first try to solve your problem over the phone. If they are unsuccessful, you can arrange for EasyServ service by calling the PC Support Line.

If possible, you should use the original ThinkPad shipping materials that your computer came in, for re-sending it to IBM. If the box is not available, the courier will deliver a shipping carton and will return later to pick it up. This service is available only in the U.S. and Canada.

Getting Help around the World

If you make frequent overseas trips or you are residing abroad, you can register with the International Warranty Service Office. The office will issue an International Warranty Service Certificate, which you can use wherever IBM or IBM resellers sell and service IBM PC products.

For more information on registering with the International Warranty Service Office, call 1-800-497-7426 in the U.S. or Canada.

Online Housecall

Online Housecall is a remote communication tool that allows an IBM technical-support representative to access your PC by modem. Many problems can be diagnosed quickly and easily through this method. A modem and a remote access application program are required. There may be a charge for this service.

For more information on configuring your computer for Online Housecall, call:

In the U.S., 1-800-772-2227

In Canada, 1-800-565-3344

Fax Information

In the U.S. and Canada, if you have a touch-tone telephone and access to a fax machine, you can receive marketing and technical information on such topics as computer hardware, operating systems, and local area networks (LANs) by fax. You can call the IBM PC Company Automated Fax System 24 hours a day, 7 days a week. Follow the recorded instructions, and the information that you request will be sent your fax machine.

To access the IBM PC Company Automated Fax System, call:

In the U.S., 1-800-426-3395

In Canada, 1-800-465-3299 a)

Electronic Support Services

If you have a modem, you can access such public information services as the electronic bulletin boards and messaging areas, electronic conferences, and searchable databases available in several of the most popular online information services.

Bulletin boards and online services contain information on many topics such as:

- PC user groups
- PC questions and answers
- OS/2 topics
- Problem solving
- Technical information
- Hardware and software configurations
- Networking

The IBM PC Company Bulletin Board System (BBS) can be reached 24 hours a day, 7 days a week. Modem speeds of up to 14,400 baud are supported. Long-distance telephone charges may apply.

To access the PC Company BBS, call:

- In the U.S., 1-919-517-0001
- For Canada, call the center closest to you:
 - 905-316-4255 (Markham)
 - 514-938-3022 (Montreal)
 - 416-492-1823 (Toronto)
 - 604-664-6466 (Vancouver)

Commercial online services that have information on IBM products are:

- CompuServe:
Use the **GO** word **ThinkPad**.
- Prodigy:
Use the **Jump** command; type **IBM** and select **PC Product Support**.
- America Online:
Use the **Go to** keyword **IBM**.

Purchasing Additional Services

During and after the warranty period, you can purchase additional services, such as:

- Support for IBM and non-IBM hardware, operating systems, and application programs
- Network setup and configuration
- Upgraded or extended hardware repair services
- Custom installation

The availability of the service and its name might vary by country.

Enhanced PC Support Line

Enhanced PC Support is available for desktop and mobile IBM computers that are not connected to a network. Technical support is provided for IBM computers and IBM or non-IBM options, operating systems, and application programs on the supported products list.

This service includes technical support for the following:

- Installing and configuring your out-of-warranty IBM computer
- Installing and configuring non-IBM options in IBM computers
- Assistance with the preloaded operating system
- Using selected application software and games
- Tuning performance, such as memory management
- Installing device drivers remotely
- Setting up and using multimedia devices
- Identifying system problems
- Interpreting documentation

You can purchase this service for a single incident or for multiple incidents. For more information about purchasing the Enhanced PC Support, see "Ordering Support Line Services" on page 5-9.

Network and Server Support Line

Network and Server Support includes all the features of the Enhanced PC Support Line and is available for simple and complex networks made up of IBM workstations and servers using major network operating systems. This line also supports the many popular non-IBM adapters and network interface cards.

This service includes technical support for the following:

- Installing and configuring client workstations and servers
- Identifying system problems and correcting problems on the client or the server
- Using IBM and non-IBM network operating systems
- Interpreting documentation

You can purchase this service for a single incident or for multiple incidents. For more information about purchasing Network and Server Support, see "Ordering Support Line Services."

Ordering Support Line Services

Enhanced PC Support Line and the Network and Server Support Line services are available for products on the Supported Products list.

To receive a Supported Products list,

In the U.S:

- Call 1-800-772-2227.
- Select the automated fax system option.
- Select the service for which you would like a Supported Products list:
 - For Enhanced PC Support Line, select document 11682.
 - For Network and Server Support Line, select document 11683.

In Canada:

- Call 1-800-465-7999 or 1-800-465-3299
- In other countries, contact your IBM reseller or IBM marketing representative.

For more information on how to purchase the Support Line Services:

In the U.S.: call 1-800-772-2227.

In Canada: call 1-800-465-7999.

In other countries, contact your IBM reseller or IBM marketing representative.

Warranty and Repair Services

You can upgrade your ThinkPad EasyServ/Customer Carry-In warranty services or extend their period of service.

Upgradable warranties for the U.S. include:

Overnight service option. You can upgrade your current warranty that provides ThinkPad EasyServ/Carry-in repair service. Your warranty provides ThinkPad EasyServ/Carry-in repair service.

You can also extend your period of warranty. The “Warranty and Repair Services” offers a ThinkPad EasyServ Maintenance Agreement.

For more information on warranty upgrades and extensions:

In the U.S.: call 1-800-426-7697.

In Canada: call 1-800-465-7999.

In other countries, contact your IBM reseller or IBM marketing representative.

Obtaining IBM Operating System Updates

IBM provides update diskettes, called ServicePaks or corrective service diskettes (CSDs), to customers who report a DOS or OS/2 problem for which there is or will be a corrective program.

Getting Update Diskettes

You can obtain update diskettes from:

- IBM PC Company BBS.
- IBM Software Solutions Center (1-800-992-4777 for the U.S. and Canada)
- An IBM authorized reseller or an IBM marketing representative.

Ordering Publications

Additional publications are available for purchase from IBM. For a list of publications available in your country:

- In the U.S. and Puerto Rico: call IBM PC Books at 1-800-426-7282.
- In Canada: call 1-800-465-1234.
- In other countries, contact your IBM authorized reseller or IBM marketing representative.

About Your Warranty

During the warranty period, you may be responsible for repair costs if the product damage was due to misuse, accident, modification, unsuitable physical or operating environment, or improper maintenance.

For full information on product warranties, see Appendix D.



Appendix A. Operating Requirements

This appendix describes the following:

Specifications	A-2
Operating Environment	A-3
Power Cord Requirements	A-5
For 2-Pin Power Cords	A-5
For 3-Pin Power Cords	A-6

Specifications

Component	13.1-Inch TFT Model	14.1-Inch TFT Model
Processor	Pentium MMX 200 or 233 MHz	Pentium MMX 233 MHz
Second-level cache	512 KB	512 KB
Memory Built-in Optional DIMM	32 MB 16 MB, 32 MB, or 64 MB	32 MB 16 MB, 32 MB, or 64 MB
Hard disk size	3.2/4.0 GB	5.1 GB
Diskette drive	1.44 MB	1.44 MB
CD-ROM drive	8X to 20X (Optional)	8X to 20X (Optional)
DVD Drive	Optional	Optional
DVD and Enhanced Video Adapter	Optional	Yes
Audio	Stereo	Stereo
Modem	No	33.6 Kbps (upgradable)
Infrared ports	4 Mbps	4 Mbps
Universal Serial Bus	Yes	Yes
CardBus/ZV	Yes	Yes
Pointing device	TrackPoint	TrackPoint
Battery	9 cell lithium-ion	9 cell lithium-ion
AC Adapter	56 W	56 W

Dimensions		
Width	313 mm (12.3 in.)	313 mm (12.3 in.)
Depth	240 mm (9.4 in.)	254 mm (10.0 in.)
Height	56 mm (2.2 in.)	56 mm (2.2 in.)

Operating Environment

Your computer operates under the following conditions:

Model	13.1-Inch TFT	14.1-Inch TFT
Air temperature		
System on (without diskette)	5° to 35°C (41° to 95°F)	5° to 35°C (41° to 95°F)
System on (with diskette)	10° to 35°C (50° to 95°F)	10° to 35°C (50° to 95°F)
System off	5° to 43°C (41° to 110°F)	5° to 43°C (41° to 110°F)
Storage and shipment	-20° to 60°C (-4° to 140°F)	-20° to 60°C (-4° to 140°F)
Wet bulb (maximum)	29.4°C (85°F)	25.7°C (78°F)

Humidity	
System on (without diskette)	8% to 95%
System on (with diskette)	8% to 80%
Storage and shipment	5% to 95%

Maximum altitude	
System on or off	3050 m (10,000 ft.)
Storage and shipment	12,200 m (40,000 ft.)*
Heat output	56 W (191 BTUs/hour) maximum
Shock or vibration	Damage boundary 210 G/3 ms, 70 G/11 ms

Note: * The atmospheric pressure must be more than 715 Hecto-Pascal.

Power Cord Requirements

IBM power cords for a specific country are usually available only in that country.

For 2-Pin Power Cords

IBM Power Cord Part Number	Used in These Countries
13H5264	Bahamas, Barbados, Bermuda, Bolivia, Canada, Cayman Islands, Colombia, Costa Rica, Dominican Republic, Ecuador, El Salvador, Guatemala, Guyana, Haiti, Honduras, Jamaica, Korea (South), Mexico, Netherlands Antilles, Nicaragua, Panama, Peru, Philippines, Saudi Arabia, Suriname, Taiwan, Thailand, Trinidad (West Indies), United States of America, Venezuela
13H5267	Abu Dhabi, Albania, Antigua, Bahrain, Brunei, Dubai, Fiji, India, Ireland, Kenya, Kuwait, Macao, Malasia, Nigeria, Oman, People's Republic of China, Qatar, Singapore, United Kingdom
13H5270	Austria, Belgium, Bulgaria, Chile, Czech Republic, Denmark, Egypt, Finland, France, Germany, Greece, Hungary, Iceland, Indonesia, Israel, Italy, Netherlands, Norway, Poland, Portugal, Romania, Slovakia, Spain, Sweden, Switzerland, Turkey, former Yugoslavia
13H5273	Japan
13H5276	Argentina, Australia, New Zealand, Papua New Guinea, Paraguay, Uruguay
13H5279	Bangladesh, Pakistan, South Africa, Sri Lanka

For 3-Pin Power Cords

Note: The grounded adapter is required for full MPRII compliance.

IBM Power Cord Part Number	Used in These Countries
76H3514	Argentina, Australia, Papua New Guinea, New Zealand, Paraguay, People's Republic of China, Uruguay
76H3516	Aruba, Bahamas, Barbados, Bermuda, Bolivia, Brazil, Canada, Cayman Islands, Colombia, Costa Rica, Curacao, Dominican Republic, Ecuador, El Salvador, Guatemala, Guyana, Haiti, Honduras, Jamaica, Korea (South), Liberia, Mexico, Netherlands Antilles, Nicaragua, Panama, Peru, Philippines, Saudi Arabia, Suriname, Taiwan, Thailand, Trinidad (West Indies), United States of America, Venezuela
76H3518	Austria, Belgium, Bulgaria, Czech Republic, Egypt, Finland, France, Germany, Greece, Hungary, Iceland, Indonesia, Macao, Netherlands, Norway, Poland, Portugal, Romania, Slovakia, Spain, Sweden, Turkey, former Yugoslavia
76H3520	Denmark
76H3522	Bangladesh, Pakistan, Myanmar, South Africa, Sri Lanka
76H3524	Abu Dhabi, Albania, Antigua, Bahrain, Brunei, Dubai, Fiji, India, Ireland, Kenya, Kuwait, Malaysia, Nigeria, Oman, Qatar, Singapore, United Kingdom
76H3526	Japan
76H3528	Switzerland, Liechtenstein
76H3530	Chile, Italy, Ethiopia, Libya
76H3532	Israel
76H3535	Korea

Appendix B. Installing a New Operating System

This appendix explains how to install an operating system. You can replace the preloaded Windows 95 or Windows NT operating system with the following operating systems:

- IBM PC DOS Version 7.0
- Microsoft Windows 3.1
- Microsoft Windows 95
- Microsoft Windows NT Version 3.51 or 4.0
- IBM Operating System/2 (OS/2) Warp Version 3 or 4

To install a new operating system, do the following:

- 1** Have the new operating system installation package on hand.
- 2** Make a backup copy of your software and all data files in the hard disk.
- 3** Make a printout of the “Installing Software” section in the online book. Refer to “Using the ThinkPad Online Book” on page 2-15.
- 4** Create the various device driver diskettes using the *Diskette Factory* program by doing the following:
 - a) Click on the **ThinkPad Tools** icon in the Windows desktop, and double-click on **Diskette Factory**. The “Diskette Factory” window appears:



- b) Select the operating system that you want to install; then click on **Yes**. The following window appears:

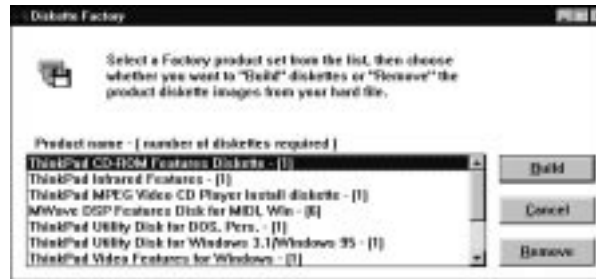

You will need about 30 blank diskettes, depending on the operating system that you will be installing.

- c) Click on all the diskette names and then click on **Build** to create the device driver diskettes.

- 5** Install the new operating system and the device driver diskettes by following the instructions on the printout.

To Get the Latest Information on Device Drivers

Connect to the IBM PC Company home page (<http://www.us.pc.ibm.com/thinkpad/thinkpad.html>) on the Internet and download the device drivers.

Appendix C. Ergonomics Information

This is important information to read before using your ThinkPad computer.

Working while “on the go” may mean adapting to frequent changes in your environment. Following some simple “rules of the road” will make things easier and bring you the maximum benefits of your ThinkPad computer. Keeping in mind such basics as good lighting and proper seating, for example, can go a long way in helping you enhance your performance and achieve greater comfort wherever you are.

What if I am traveling?

It may not be possible to observe the best ergonomic practices when you are using the ThinkPad computer while on the move or in a “casual” setting, such as the seashore or on a mountaintop. Sometimes, your lap may be the only “desk” around. Regardless of the setting, try to observe as many of the tips for proper usage as possible. Sitting properly and using adequate lighting, for example, will help you maintain desirable comfort and performance levels.

Questions about vision?

IBM's visual display screens are designed to meet the highest standards and to provide you with clear, crisp images and large, bright displays that are easy to see, yet easy on the eyes. Of course, any concentrated and sustained visual activity can be tiring. If you have questions on eye fatigue or visual discomfort, consult a vision care specialist for advice.

Note: The example shown here of someone in a traditional setting. Even when not in such a setting, you can follow many of these tips. Develop good habits and they will serve you well.

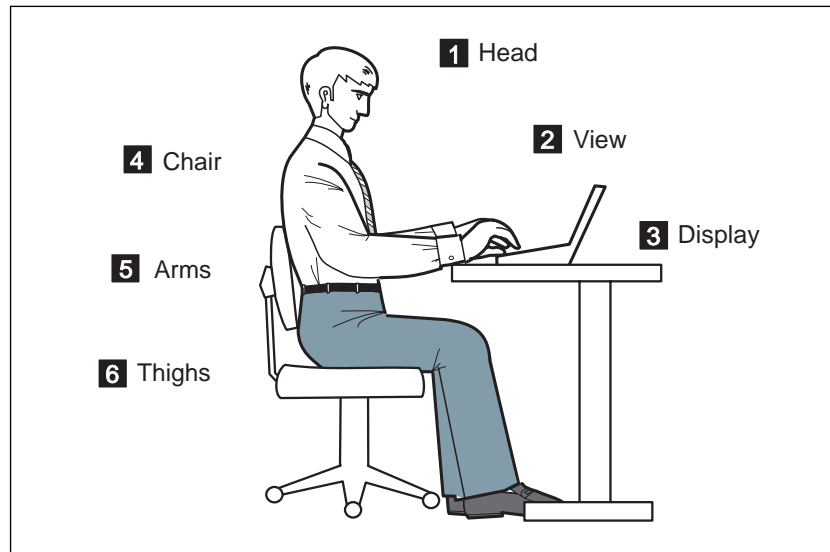

- | | |
|---|---|
| <p>1 Head
Keep your head in a comfortable and vertical position.</p> <p>2 View
Maintain a comfortable viewing distance of 20–30 inches.</p> <p>3 Display
Position the display to avoid glare or reflections from overhead lighting or outside sources of light.

Keep the display screen clean and set the contrast and brightness to levels that allow you to see the screen clearly.</p> | <p>4 Chair
Use a chair that gives you good back support.</p> <p>5 Arms
Keep your forearms, wrists, and hands in a relaxed and neutral position. Don't pound the keys; type with a soft touch.</p> <p>6 Thighs
Keep your thighs parallel to the floor and your feet flat on the floor or on a footrest.</p> |
|---|---|

Appendix D. Product Warranty

International Business Machines Corporation

Armonk, New York 10504

United States, Puerto Rico and Canada Statement of Limited Warranty

The warranties provided by IBM in this Statement of Limited Warranty apply only to Machines you originally purchase for your use, and not for resale, from IBM or an IBM authorized reseller. The term "Machine" means an IBM machine, its features, conversions, upgrades, elements, or accessories, or any combination of them. Machines are subject to these terms only if purchased in the United States or Puerto Rico, or Canada, and located in the country of purchase. If you have any questions, contact IBM or your reseller.

Machine: IBM ThinkPad 770

Warranty Period*: Three years, One Year on Battery

**Elements and accessories are warranted for three months. Contact your place of purchase for warranty service information.*

Production Status

Each Machine is manufactured from new parts, or new and serviceable used parts (which perform like new parts). In some cases, the Machine may not be new and may have been previously installed. Regardless of the Machine's production status, IBM's warranty terms apply.

The IBM Warranty

IBM warrants that each Machine 1) is free from defects in materials and workmanship and 2) conforms to IBM's Official Published Specifications. IBM calculates the expiration of the warranty period from the Machine's Date of Installation. The date on your receipt is the Date of Installation, unless IBM or your reseller informs you otherwise.

During the warranty period, IBM or your reseller will provide warranty service under the type of service designated for the Machine and will manage and install engineering changes that apply to the Machine. IBM or your reseller will specify the type of service.

For a feature, conversion, or upgrade, IBM or your reseller may require that the Machine on which it is installed be 1) the designated, serial-numbered Machine and 2) at an engineering-change level compatible with the feature, conversion, or upgrade. Some of these transactions (called "Net-Priced" transactions) may include additional parts and associated replacement parts that are provided on an exchange basis. All removed parts become the property of IBM and must be returned to IBM.

Replacement parts assume the remaining warranty of the parts they replace.

If a Machine does not function as warranted during the warranty period, IBM or your reseller will repair or replace it (with a Machine that is at least functionally equivalent) without charge. If IBM or your reseller is unable to do so, you may return it to your place of purchase and your money will be refunded.

If you transfer a Machine to another user, warranty service is available to that user for the remainder of the warranty period. You should give your proof of purchase and this Statement to that user.

Warranty Service

To obtain warranty service for the Machine, you should contact your reseller or call IBM. In the United States, call IBM at **1-800-772-2227**. In Canada, call IBM at **1-800-565-3344**. You may be required to present proof of purchase.

Depending on the Machine, the service may be 1) a "Repair" service at your location (called "On-site") or at one of IBM's or a reseller's service locations (called "Carry-in") or 2) an "Exchange" service, either On-site or Carry-in.

When a type of service involves the exchange of a Machine or part, the item IBM or your reseller replaces becomes its property and the replacement becomes yours. The replacement may not be new, but will be in good working order and at least functionally equivalent to the item replaced.

It is your responsibility to:

1. obtain authorization from the owner (for example, your lessor) to have IBM or your reseller service a Machine that you do not own;
2. where applicable, before service is provided —
 - a) follow the problem determination, problem analysis, and service request procedures that IBM or your reseller provide,
 - b) secure all programs, data, and funds contained in a Machine,
 - c) inform IBM or your reseller of changes in a Machine's location, and
 - d) for a Machine with exchange service, remove all features, parts, options, alterations, and attachments not under warranty service. Also, the Machine must be free of any legal obligations or restrictions that prevent its exchange; and
3. be responsible for loss of, or damage to, a Machine in transit when you are responsible for the transportation charges.

Extent of Warranty

IBM does not warrant uninterrupted or error-free operation of a Machine. Unless IBM specifies otherwise, IBM provides non-IBM machines on an "AS IS" basis. However, non-IBM manufacturers may provide their own warranties to you.

Misuse, accident, modification, unsuitable physical or operating environment, improper maintenance by you, removal of product labels or parts identification labels, or failure caused by a product for which IBM is not responsible may void the warranties.

THESE WARRANTIES REPLACE ALL OTHER WARRANTIES, EXPRESS OR IMPLIED, INCLUDING, BUT NOT LIMITED TO, THE IMPLIED WARRANTIES OF MERCHANTABILITY AND FITNESS FOR A PARTICULAR PURPOSE. HOWEVER, SOME LAWS DO NOT ALLOW THE EXCLUSION OF IMPLIED WARRANTIES. IF THESE LAWS APPLY, THEN ALL EXPRESS AND IMPLIED WARRANTIES ARE LIMITED IN DURATION TO THE WARRANTY PERIOD. NO WARRANTIES APPLY AFTER THAT PERIOD.

In Canada, warranties include both warranties and conditions.

Some jurisdictions do not allow limitations on how long an implied warranty lasts, so the above limitation may not apply to you.

Limitation of Liability

Circumstances may arise where, because of a default on IBM's part (including fundamental breach) or other liability (including negligence and misrepresentation), you are entitled to recover damages from IBM. In each such instance, regardless of the basis on which you are entitled to claim damages, IBM is liable only for:

1. bodily injury (including death), and damage to real property and tangible personal property; and
2. the amount of any other actual loss or damage, up to the greater of \$100,000 or the charge for the Machine that is the subject of the claim.

Under no circumstances is IBM liable for any of the following:

1. third-party claims against you for losses or damages (other than those under the first item listed above);
2. loss of, or damage to, your records or data; or

3. economic consequential damages (including lost profits or savings) or incidental damages, even if IBM is informed of their possibility.

Some jurisdictions do not allow the exclusion or limitation of incidental or consequential damages, so the above limitation or exclusion may not apply to you.

This warranty gives you specific legal rights and you may also have other rights which vary from jurisdiction to jurisdiction.



Appendix E. Notices

References in this publication to IBM products, programs, or services do not imply that IBM intends to make these available in all countries in which IBM operates. Any reference to an IBM product, program, or service is not intended to state or imply that only that IBM product, program, or service may be used. Any functionally equivalent product, program, or service that does not infringe any of the intellectual property rights of IBM may be used instead of the IBM product, program, or service. The evaluation and verification of operation in conjunction with other products, except those expressly designated by IBM, are the responsibility of the user.

IBM may have patents or pending patent applications covering subject matter in this document. The furnishing of this document does not give you any license to these patents. You can send license inquiries, in writing, to the IBM Director of Licensing, IBM Corporation, 500 Columbus Avenue, Thornwood, NY 10594, U.S.A.

Trademarks

The following terms are trademarks of the IBM Corporation in the United States or other countries or both:

IBM	Presentation Manager
HelpCenter	PS/2
HelpWare	RediSafe
MMPM/2	SelectaDock
Multimedia Presentation Manager/2	ThinkPad
Operating System/2	TrackPoint
OS/2	WIN-OS/2
PC Card Director	Ultimotion

Microsoft, Windows NT, and the Windows 95 flag logo are trademarks or registered trademarks of the Microsoft Corporation.

Pentium , MMX , VideoPhone , ProShare , LANDesk , and ActionMedia are trademarks or registered trademarks of Intel Corporation in the U.S. and other countries.

Other company, product, and service names, which may be denoted by a double asterisk (**), may be trademarks or service marks of others.

Electronic Emission Notice

Federal Communications Commission (FCC) Statement

IBM ThinkPad Model 770, 9548, 9549

This equipment has been tested and found to comply with the limits for a Class B digital device, pursuant to Part 15 of the FCC Rules. These limits are designed to provide reasonable protection against harmful interference in a residential installation. This equipment generates, uses, and can radiate radio frequency energy and, if not installed and used in accordance with the instructions, may cause harmful interference to radio communications. However, there is no guarantee that interference will not occur in a particular installation. If this equipment does cause harmful interference to radio or television reception, which can be determined by turning the equipment off and on, the user is encouraged to try to correct the interference by one or more of the following measures:

- Reorient or relocate the receiving antenna.
- Increase the separation between the equipment and receiver.
- Connect the equipment into an outlet on a circuit different from that to which the receiver is connected.
- Consult an IBM authorized dealer or service representative for help.

Properly shielded and grounded cables and connectors must be used in order to meet FCC emission limits. Proper cables and connectors are available from IBM authorized dealers. IBM is not responsible for any radio or television interference caused by using other than recommended cables and connectors or by unauthorized changes or modifications to this equipment. Unauthorized changes or modifications could void the user's authority to operate the equipment.

This device complies with Part 15 of the FCC Rules. Operation is subject to the following two conditions: (1) this device may not cause harmful interference, and (2) this device must accept any interference received, including interference that may cause undesired operation.

Responsible Party:

International Business Machines
Old Orchard Road
Armonk, NY 10504
Telephone 1-919-543-2193

Canadian Department of Communications Compliance Statement

This equipment does not exceed Class B limits per radio noise emissions for digital apparatus, set out in the Radio Interference Regulation of the Canadian Department of Communications.

Avis de conformité aux normes du ministère des Communications du Canada

Cet équipement ne dépasse pas les limites de Classe B d'émission de bruits radioélectriques pour les appareils numériques, telles que prescrites par le Règlement sur le brouillage radioélectrique établi par le ministère des Communications du Canada.

European Community Directive Conformance Statement

This product is in conformity with the protection requirements of EC Council Directive 89/336/EEC on the approximation of the laws of the Member States relating to electro-magnetic compatibility.

A declaration of Conformity with the requirements of the Directive has been signed by IBM United Kingdom Limited, PO BOX 30 Spango Valley Greenock Scotland PA160AH.

This product satisfies the Class B limits of EN 55022.

Telecommunication Notice

Federal Communications Commission (FCC) and Telephone Company Requirements (Part 68 of the FCC Rules)

1. The Telephone Consumer Protection Act of 1991 makes it unlawful for any person to use a computer or other electronic device to send any message via a telephone fax machine unless such message clearly contains in a margin at the top or bottom of each transmitted page or on the first page of the transmission, the date and time it is sent and an identification of the business or other entity, or other individual sending the message and the telephone number of the sending machine or such business, other entity, or individual.

In order to program this information into your computer, you should be sure to follow the installation instructions for your fax software package.

2. The built-in modem is built into the ThinkPad computer. It complies with Part 68 of the FCC Rules. A label is affixed to the bottom of the computer that contains, among other things, the FCC registration number, USOC, and Ringer Equivalency Number (REN) for this equipment. If these numbers are requested, look at the label and provide this information to your telephone company.
3. The REN is useful to determine the quantity of devices you may connect to your telephone line and still have those devices ring when your number is called. In most, but not all, areas, the sum of the RENs of all devices should not exceed five (5.0). To be certain of the number of devices you may connect to your line, as determined by the REN, you should call your local telephone company to determine the maximum REN for your calling area.
4. If the built-in modem causes harm to the telephone network, the telephone company may discontinue your service temporarily. If possible, they will notify you in advance. But, if advance notice isn't practical, you will be notified as soon as possible. You will be advised of your right to file a complaint with the FCC.
5. Your telephone company may make changes in its facilities, equipment, operations, or procedures that could affect the proper operation of your equipment. If they do, you will be given advance notice so as to give you an opportunity to maintain uninterrupted service.
6. If you experience trouble with this built-in modem, contact your IBM Authorized Seller, or the IBM Corporation, 500 Columbus Avenue, Thornwood, NY 10594, 1-800-772-2227, for repair/warranty information. The telephone company may ask you to disconnect this equipment from

the network until the problem has been corrected, or until you are sure the equipment is not malfunctioning.

- 7.** No customer repairs are possible to the modem. If you experience trouble with this equipment, contact your Authorized Seller or the IBM Corporation for information.
- 8.** The modem may not be used on coin service provided by the telephone company. Connection to party lines is subject to state tariffs. Contact your state public utility commission or corporation commission for information.
- 9.** When ordering network interface (NI) service from the Local Exchange Carrier, specify service arrangement USOC RJ11C.

Industry Canada Requirements

Notice

The Industry Canada label identifies certified equipment. This certification means that the equipment meets certain telecommunications networks protective, operational and safety requirements. The Department does not guarantee the equipment will operate to the user's satisfaction.

Before installing this equipment, users should ensure that it is permissible to be connected to the facilities of the local telecommunications company. The equipment must also be installed using an acceptable method of communication. In some cases, the company's inside wiring associated with a single line individual service may be extended by means of a certified connector assembly (telephone extension cord). The customer should be aware that compliance with the above conditions may not prevent degradation of service in some situations.

Repairs to certified equipment should be made by an authorized Canadian maintenance facility designated by the supplier. Any repairs or alterations made by the user to this equipment, or equipment malfunctions, may give the telecommunications company cause to request the user to disconnect the equipment.

Users should ensure for their own protection that the electrical ground connections of the power utility, telephone lines and internal metallic water pipe system, if present, are connected together. This precaution may be particularly important in rural areas.

Caution

Users should not attempt to make such connections themselves, but should contact the appropriate electric inspection authority, or electrician, as appropriate.

Notice

The **Ringer Equivalent Number (REN)** assigned to each terminal device provides an indication of the maximum number of terminals allowed to be connected to a telephone interface. The termination on an interface may consist of any combination of devices subject only to the requirement that the sum of the Ringer Equivalence Number of all the devices does not exceed 5.

Avis

L'étiquette du ministère de l'Industrie Canada identifie le matériel homologué. Cette étiquette certifie que le matériel est conforme à certaines normes de protection, d'exploitation et de sécurité des réseaux de télécommunications. Le Ministère n'assure toutefois pas que le matériel fonctionnera à la satisfaction de l'utilisateur.

Avant d'installer ce matériel, l'utilisateur doit s'assurer qu'il est permis de le raccorder aux installations de l'entreprise locale de télécommunication. Le matériel doit également être installé en suivant une méthode acceptée de raccordement. Dans certains cas, les fils intérieurs de l'entreprise utilisés pour un service individuel à ligne unique peuvent être prolongés au moyen d'un dispositif homologué de raccordement (cordon prolongateur téléphonique interne). L'abonné ne doit pas oublier qu'il est possible que la conformité aux conditions énoncées ci-dessus n'empêchent pas la dégradation du service dans certaines situations. Actuellement, les entreprises de télécommunication ne permettent pas que l'on raccorde leur matériel à des jacks d'abonné, sauf dans les cas précis prévus par les tarifs particuliers de ces entreprises.

Les réparations de matériel homologué doivent être effectuées par un centre d'entretien canadien autorisé désigné par le fournisseur. La compagnie de télécommunications peut demander à l'utilisateur de débrancher un appareil à la suite de réparations ou de modifications effectuées par l'utilisateur ou à cause de mauvais fonctionnement.

Pour sa propre protection, l'utilisateur doit s'assurer que tous les fils de mise à la terre de la source d'énergie électrique, des lignes téléphoniques et des canalisations d'eau métalliques, s'il y en a, sont

raccordés ensemble. Cette précaution est particulièrement importante dans les régions rurales.

Avertissement

L'utilisateur ne doit pas tenter de faire ces raccordements lui-même; il doit avoir recours à un service d'inspection des installations électriques, ou à électricien, selon le cas.

L'indice de charge (IC) assigné à chaque dispositif terminal indique, pour éviter toute surcharge, le pourcentage de la charge totale qui peut être raccordée à un circuit téléphonique bouclé utilisé par ce dispositif. La terminaison du circuit bouclé peut être constituée de n'importe quelle combinaison de dispositifs, pourvu que la somme des indices de charge de l'ensemble des dispositifs ne dépasse pas 100.

Numerics

56 Kbps modem, using 2-41

A

ac power jack 1-5
adapter bay 1-6
America Online 5-7
audio 1-13
 problems 4-22
audio features, using 2-35

B

backup battery 3-11
battery pack 1-4, 3-6
 problems 4-17
battery save method 2-26, 2-30
battery status check 2-31
battery status indicator 1-7
bottom compartment 1-6
brightness control lever 1-3
built-in microphone 1-3
bulletin boards 5-6

C

caps lock indicator 1-8
CD-ROM drive 1-3, 3-7
 problems 4-18
charge lamp 1-5
click buttons 1-3
coin screw 1-6
cold dock 3-20
cold plug 1-12
cold undock
 docking station 3-17
cold unplug 1-12
CompuServe 5-7
controls 1-2
corrective service diskette (CSD) 5-11
cover release latch 1-3

D

dealer locations 5-4
device in UltraBay II 3-7
diagnostic diskette 5-11
diskette drive 1-3, 3-7
diskette drive in-use indicator 1-8
diskette drive-in-use lamp 1-3
diskette eject button 1-3
display
 problems 4-16
docking station 3-17
 cold dock 3-17
 cold undock 3-17
 hot dock 3-17
 hot undock 3-17
 warm dock 3-17
 warm undock 3-17
drive-in-use lamp 1-3
DVD
 drive 1-3
 player 2-50
DVD and Enhanced Video Adapter
 installing 3-10
 using 2-44
DVD drive 3-7

E

Easy-Setup
 changing drive startup
 sequence 2-57
 knowing your configuration 2-56
 setting date and time 2-57
 using 2-54
EasyServ 5-5
eject button 1-3
electronic support 5-6
emergency eject hole 1-3
enhanced PC support line 5-8
enhanced video/MPEG features
 problems 4-22
ergonomics information C-1
error codes 4-5
external display

external display (*continued*)
 port 1-5
 problems 4-27, 4-29
 external keyboard 3-13
 external numeric keypad
 problems 4-11
 external-diskette-drive port 1-5
 external-input-device port 1-5

F

fan louvers 1-5
 fee, services 5-8
 Fn key 1-3, 1-9
 fuel program, using 2-32
 function keys
 Fn + F11 1-10
 Fn + F12 1-10, 2-26
 Fn + F2 1-9, 2-33
 Fn + F3 1-9, 2-26
 Fn + F4 1-9, 2-26
 Fn + F7 1-10, 2-7, 2-8, 2-50, 2-51
 Fn + F8 1-10
 functional highlights 1-13
 audio 1-13
 audio with 3D stereo sound 1-13
 DVD 1-13
 infrared port 1-14
 system management features 1-14
 TrackPoint 1-14
 video capture 1-13
 video phone 1-14

H

hard disk bay 1-6
 hard disk drive 3-5
 hard disk in-use indicator 1-8
 hard disk password 2-16
 hardware 1-2
 AC power jack 1-5
 adapter bay 1-6
 battery pack 1-4
 bottom compartment 1-6
 brightness control lever 1-3

hardware (*continued*)
 built-in microphone 1-3
 charge lamp 1-5
 click buttons 1-3
 coin screw 1-6
 cover release latch 1-3
 diskette drive-in-use lamp 1-3
 diskette eject button 1-3
 drive-in-use lamp 1-3
 eject button 1-3
 emergency eject hole 1-3
 external-diskette-drive port 1-5
 external-display port 1-5
 external-input-device port 1-5
 fan louvers 1-5
 Fn key 1-3
 front infrared port 1-6
 function keys 1-3
 hard disk bay 1-6
 headphone jack 1-5
 internal modem port 1-2
 internal speakers 1-3
 LCD 1-2
 LCD indicator panel 1-3
 LED 1-3
 microphone/line-in jack 1-5
 numeric keypad 1-2
 parallel port 1-5
 PC Card eject buttons 1-3
 PC Card slot 1-3
 power switch 1-5
 power-on lamp 1-5
 release latches 1-3
 reset switch 1-5
 security keyhole 1-5
 security screws 1-6
 serial port 1-5
 system-expansion port 1-5
 TrackPoint 1-3
 UltraBay II 1-3
 universal serial bus (USB) 1-5
 video-in port 1-4
 video-out port 1-5
 volume control 1-5
 headphone jack 1-5

- hibernation mode
 - enabling 2-28
 - problems 4-12
- hot dock 3-19
- hot plug 1-12
- hot undock
 - docking station 3-17
- hot unplug 1-12

I

- I99xxxx
 - See error codes
- identification numbers, recording 5-2
- indicator
 - battery status 1-7
 - caps lock 1-8
 - diskette drive in-use 1-8
 - hard disk in-use 1-8
 - numeric lock 1-8
 - remaining battery 1-7
 - scroll lock 1-8
 - speaker 1-7
- infrared port
 - front 1-6
 - functional highlights 1-14
 - problems 4-21
 - rear 1-5
- internal modem
 - port 1-2
 - using 2-39
- internal speakers 1-3

K

- keyboard
 - problems 4-11

L

- lamps 1-2
- LCD 1-2
 - problems 4-16
- LCD indicator panel 1-3
- LED 1-3, 1-12

- LED (*continued*)
 - black (off) 1-12
 - blinking green 1-12
 - blinking yellow 1-12
 - green 1-12
 - yellow 1-12

M

- memory option 3-2
- messages on screen 4-5
- microphone/line-in jack 1-5
- MIDI features, using 2-37
- modem
 - problems 4-22, 4-23
- mouse 3-13
- MPEG
 - playback 2-49
 - problems 4-22

N

- Network and Server Support fee 5-8
- new operating system, installing B-1
- numeric keypad 1-2, 3-13
- numeric lock indicator 1-8

O

- online book, using the 2-15
- Online Housecall 5-6
- operating system
 - updates 5-11
- options
 - installing and removing 3-2
 - problems 4-29

P

- parallel port 1-5
- password 2-16
 - changing or removing 2-23
 - entering 2-22
 - hard disk password 2-16
 - power-on password 2-16

password (*continued*)
 setting 2-16, 2-23
 supervisor password 2-16
 using 2-23
 PC Card 3-15
 eject buttons 1-3
 problems 4-26
 slot 1-3
 personalization editor 2-24
 plug, cold 1-12
 plug, hot 1-12
 plug, warm 1-12
 pointing device
 problems 4-11
 port replicator 3-17
 POST error prompt 4-5
 power management
 hibernation mode 2-26
 standby mode 2-26
 suspend mode 2-26
 power switch 1-5
 power-on lamp 1-5
 power-on password 2-16
 printer
 problems 4-27
 problems
 audio 4-22
 battery pack 4-17
 CD-ROM drive 4-18
 DSP features 4-22
 enhanced video/MPEG
 features 4-22
 error codes 4-5
 external display 4-27
 external numeric keypad 4-11
 hibernation mode 4-12
 infrared 4-21
 keyboard 4-11
 LCD 4-16
 messages on screen 4-5
 modem 4-22
 options 4-29
 PC Card 4-26
 pointing device 4-11
 printer 4-27

problems (*continued*)
 SelectaDock 4-26
 serial port 4-29
 software 4-31
 suspend mode 4-12
 television 4-29
 testing the computer 4-32
 TrackPoint 4-11
 troubleshooting charts 4-2, 4-31
 Prodigy 5-7
 publications
 ordering 5-11

R

release latches 1-3
 remaining battery indicator 1-7
 remote technical support 5-6
 repair services 5-11
 getting service 5-11
 identification numbers 5-2
 reset switch 1-5

S

safety information vii
 sales information 5-4
 scroll lock indicator 1-8
 secondary battery pack 1-3, 3-7
 secondary hard disk drive 1-3, 3-7
 security features
 password 2-16
 personalization editor 2-24
 security keyhole 1-5
 security screws 1-6
 security system lock 3-21
 SelectaDock
 installing 3-17
 problems 4-26
 serial number 5-2
 serial port 1-5
 problems 4-29
 service 5-11
 how to get 5-11
 ServicePak 5-11

- software
 - problems 4-31
- speaker indicator 1-7
- SRS function, using 2-36
- supervisor password 2-16
- suspend mode
 - problems 4-12
 - timer 2-27
- switches 1-2
- system management features 1-14
- system-expansion port 1-5

T

- technical support 5-4
 - fee 5-8
 - remote 5-6
- telephone assistance 5-4
- telephone features 2-43
- television 3-22
 - problems 4-29
- testing the computer 4-32
- ThinkPad Configuration for Windows 95 2-3
- ThinkPad Configuration for Windows NT 2-4
- ThinkPad EasyServ 5-10
- TrackPoint 1-3, 2-10
 - cap cleaning 2-10
 - customizing 2-10
 - operation 2-9
 - problems 4-11
- troubleshooting
 - charts 4-2
 - modem 4-23
 - USB port 4-23

U

- UltraBay II 1-3
 - cold plug 1-12
 - cold unplug 1-12
 - hot plug 1-12
 - hot unplug 1-12
 - warm plug 1-12

- UltraBay II (*continued*)
 - warm unplug 1-12
- universal serial bus (USB) 1-5
 - unplug, cold 1-12
 - unplug, hot 1-12
 - unplug, warm 1-12
- updating, operating system 5-11

V

- video capture 1-13, 2-45
- video overlay 2-47
- video phone 1-14
- video-in port 1-4
- video-out port 1-5
- volume control 1-5

W

- warm dock
- warm plug 1-12
- warm undock
 - docking station 3-17
- warm unplug 1-12
- warranty D-1
 - extensions and upgrades 5-10
 - product D-1
 - service, international 5-5

IBM

Part Number: 06J0764

Printed in the United States of America

6J 764

